

SOLUTIONS FOR HEALTHCARE

Healthcare Furniture

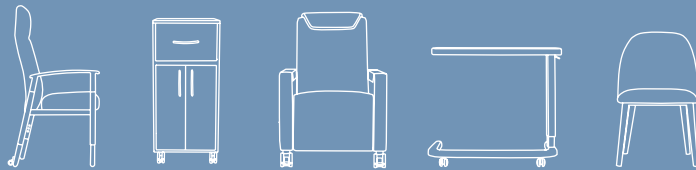

teal



teal

At Teal we believe every environment should foster comfort, compassion and wellbeing.

As a British manufacturer, we responsibly design and craft progressive, high quality patient seating, ward and medical furniture for healthcare. The major provider of Ward and Residential Furniture to the NHS throughout the UK.

But the story doesn't end there. We provide furniture solutions that help to address many of the difficulties faced in the daily management of mental health services and other challenging environments.

And we offer a range of design-led furniture and turnkey solutions aimed specifically at the residential care market, helping to address the needs of clients with specific conditions including dementia and elderly care.

We help to create therapeutic, calming environments, which transform spaces, aid recovery, enrich lives and support the delivery of exceptional care.



Contents

Introduction	04 - 29	Modular Sofas	196 - 203
Fabrics & Finishes	30 - 35	Tub & Utility Seating	204 - 217
Patient Seating	36 - 61	Dining & Café Chairs	218 - 235
Bariatric Seating	62 - 67	Stacking Chairs	236 - 243
Sleepover Solutions	68 - 77	Dining & Coffee Tables	244 - 273
Paediatric Solutions	78 - 81	Lounge Cabinets	274 - 279
Ward Furniture	82 - 97	Bedroom Furniture	280 - 291
Patient Recliners	98 - 117	Beds & Mattresses	292 - 299
Waiting & Atrium	118 - 137	Outdoor Furniture	300 - 309
Office & Multi-purpose	138 - 161	Product Dimensions	310 - 328
Sofas & Armchairs	162 - 195		

Teal is an approved NHS supplier under the following framework agreements:

NHS Medical Healthcare Furniture and Equipment 2024/S 000-025534
NHS Shared Business Services Design Furniture and Appliances 2 SBS10246
NHS Scotland Furniture and Associated Services NP785/23

Find out more:

Tel: +44 (0) 1254 688210
Sales Freephone: 0800 980 8998
Email: sales@teal.co.uk

www.teal.co.uk

Complete Solutions Provider

We control every aspect of the process from product design, to manufacturing, logistics, installation and aftercare.



Healthcare Brand
Patient seating, ward furniture and specialist products for healthcare. The major provider to the NHS in England & Wales



End-to-end Service
Major project delivery expertise; Including full Project Management for new build and refurbishment projects



Therapeutic Environments
We help satisfy the rigours of clinical environments, promote patient dignity & contribute towards a therapeutic and healing patient environment



UK Manufacturing
Products designed and manufactured in the UK at Teal's factory, tested to applicable standards



Design
We work alongside designers of international repute to deliver innovative, design led solutions



Delivery & Installation
Delivery using our own in-house fleet. Installation using a skilled, in-house experienced nationwide CSCS certified installation team



Innovative Products
Inspirational new collections for the modern healthcare facility



Sustainability
Strong sustainability credentials - all of our products are designed to be up to 100% recyclable



Bespoke Solutions
Tailoring products to meet your exact requirements



Aftercare & Support
Experienced Customer Service team with nationwide Service Support Team as part of our commitment to customer aftercare



Quality, Testing + Standards

We ensure quality at every stage of our process and are externally accredited to ISO 9001:2015. Our products are designed, manufactured, and installed to the highest levels of quality, durability and safety.

INDUSTRY LEADING WARRANTIES

All products carry a
7 year warranty

subject to standard
Terms & Conditions
(www.teal.co.uk
for details)



In compliance with our ISO:9001 accreditation we consider quality at every step of the process, and with over 1m sq. ft. of manufacturing space and 1,200 employees, we have the infrastructure and personnel in place to support this. All products come with a minimum 7-year warranty for normal wear and tear.

We have in-house design teams and we own the end-to-end manufacturing process.

We embed quality in every aspect of the process, including but not limited to:

- Use of High-Quality Materials
- Monitoring and Reporting the Quality of Goods
- Measuring Quality in our Supply Chain
- Measuring Quality in the Manufacturing Process
- Continuous improvement KPIs
- Quality Assurance checks throughout the process

Find out more about our Quality Control processes at www.teal.co.uk



Design + Manufacture

Based in Lancashire and with its own manufacturing and operations across multiple sites, Teal is the healthcare division of The Senator Group – the largest manufacturer of commercial furniture and workplace solutions in the UK and the leading investor in Research, Development and Design.

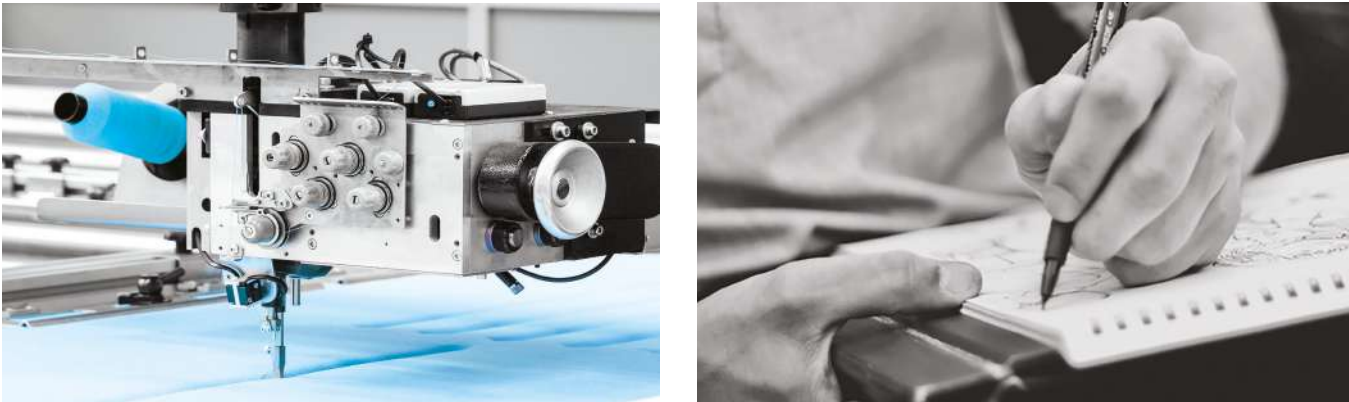

With facilities in Europe, the US and Middle East, Senator is a global brand. And even though Senator exports to over 70 countries, it remains an independent, family-owned business, controlling every aspect - from product design and innovation, to manufacturing, logistics, installation and aftercare.

A unique combination of state-of-the-art manufacturing technology together with traditional hand finishing expertise allows us to create beautifully crafted and detailed furniture and furnishing collections. As a true British manufacturer, we control every aspect of the process.

We design, we weld, we paint, we mould, we cut, we sew, ship and install.

Ethics + Sustainability

Our ESG Strategy

Our ESG commitments are near term, measurable and scalable, to ensure we deliver a consistent approach across the whole Group.

We have 46 objectives which allow us to focus our efforts and hold us accountable in delivering our long-term targets.

Our ESG Strategy is compartmentalised into three areas: Designing with Intent, Reducing our Impacts and Building Better Lives.

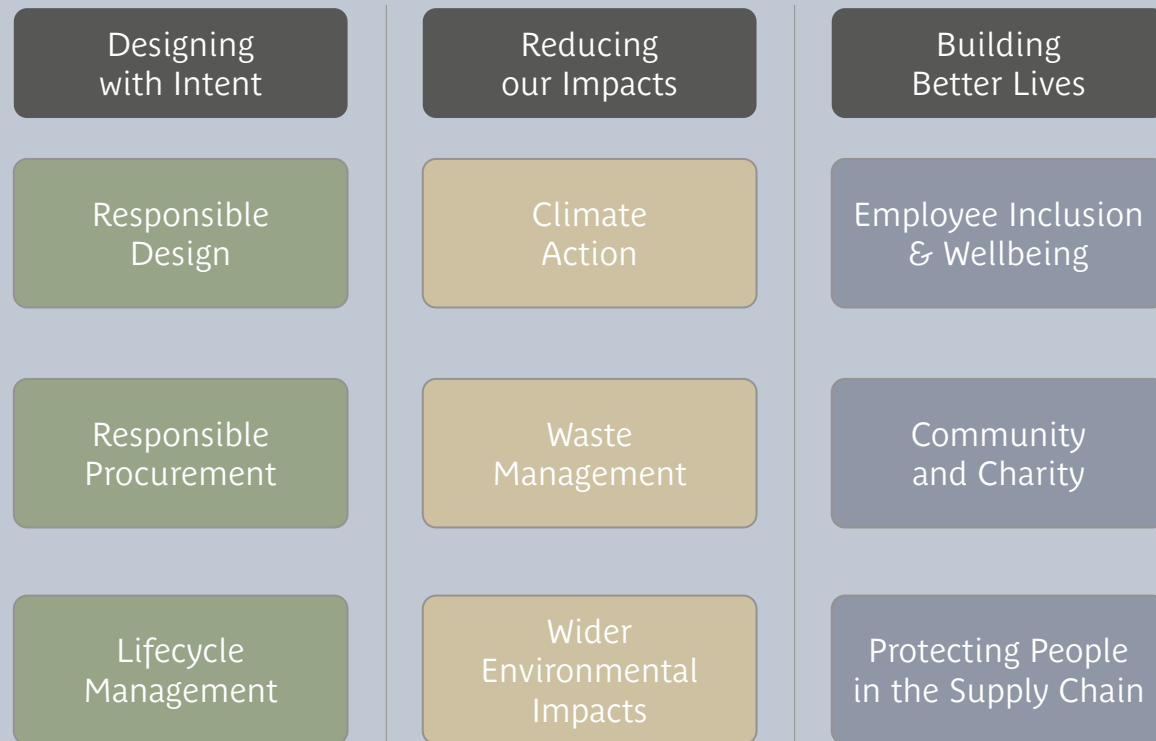

This structure steers us in reviewing the environmental and social impact of our products and operations and is supported by our strong governance structure. The following sections summarise the progress we are making against each of our objectives and allow us to be transparent in reporting our progress against each annually.

Our Pledge to Net Zero

The Senator Group UK Manufacturing and Logistics commits to reducing absolute Scope 1 and 2 greenhouse gas emissions by **50% by 2030** and by **100%** by 2040, from a 2019 baseline. We also commit to reducing Scope 3 GHG emissions to net zero by 2050.

We are proud to report that we have achieved a market-based reduction of 44.3% in Scope 1 and 2 emissions against our 2019 baseline*.

Our GHG inventory is third party verified annually.

*We have achieved a location-based reduction of 30.3% in scope 1 and 2.



Sustainable Partner to the NHS!

Teal is a sustainable partner to the NHS...

Our own sustainability strategy is closely aligned to the NHS journey to net zero and we can therefore assist NHS Trusts and Health Boards to minimise their own environmental impact through our sustainable products and services.

Talking Recycling

The role of waste management in the circular economy

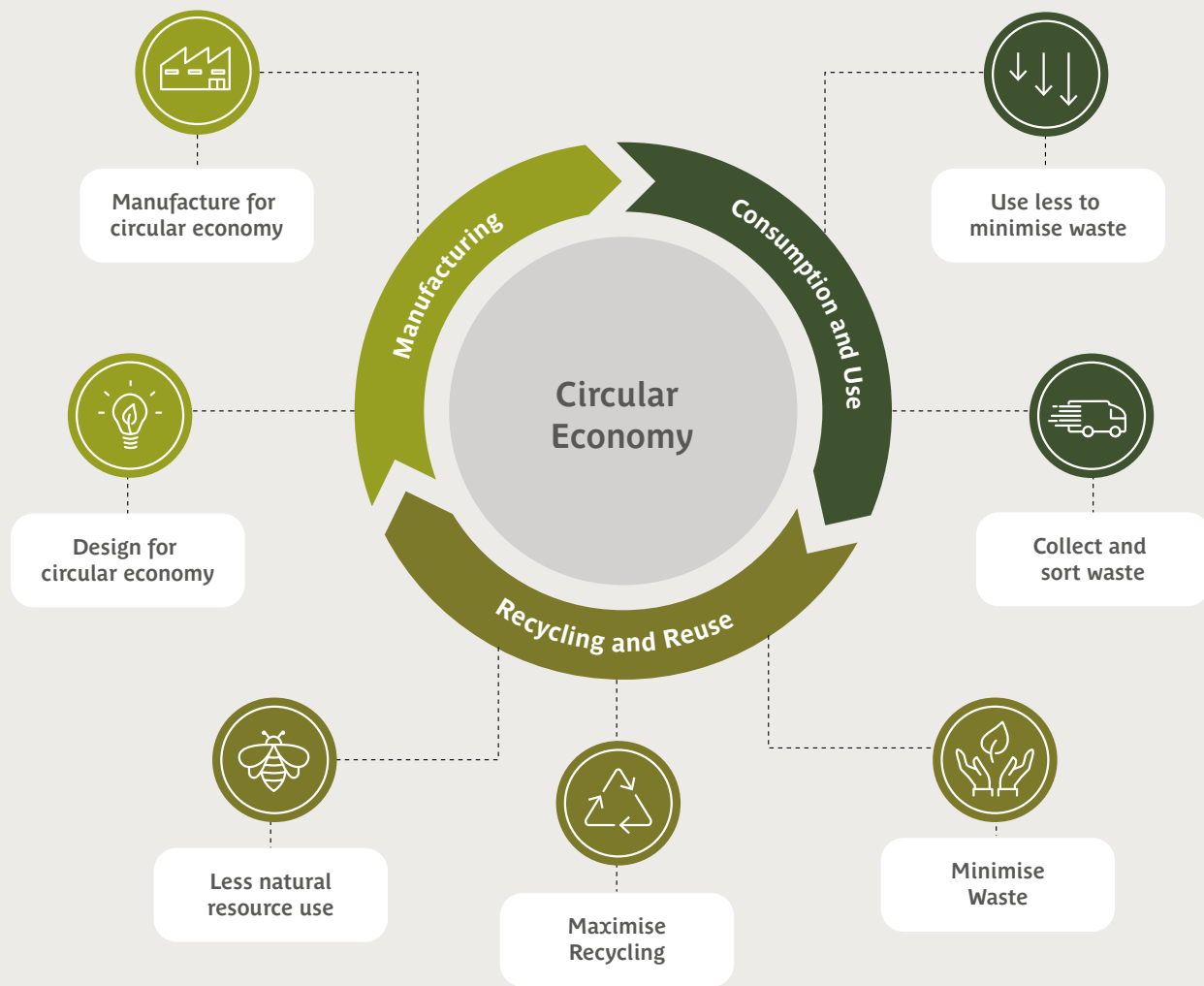

Waste minimisation and effective management is a key objective of our ESG strategy and the way we operate. Following the waste hierarchy, 'reduce, reuse, recycle' is a clear consumption mantra for the group. The emphasis is placed on reduction, be that energy, packaging and materials. Our employees are committed to waste management, whether that be in our offices, canteen or on the shop floor.

We regularly audit our waste management processes using our ISO 14001 management system to ensure best practice is being followed and to continually improve our techniques. In 2023, 87% of group operational waste was recycled.

Our packaging is 100% recyclable. We encourage recycling by utilising reverse logistics, back-loading our vehicles with post site installation packaging for processing at Sustain. Sustain offers a packaging recycling service which we call the White Bag Scheme.

This service is available for all to use, not just The Senator Group's clients, enabling everyone to responsibly recycle their packaging waste. The White Bag Scheme saw 627,750kg of packaging managed by Sustain in 2023. Much of our packaging is returned to us to use again, and last year we directly reused over 98,620 packaging items.

Supporting a Closed Loop Circular Economy

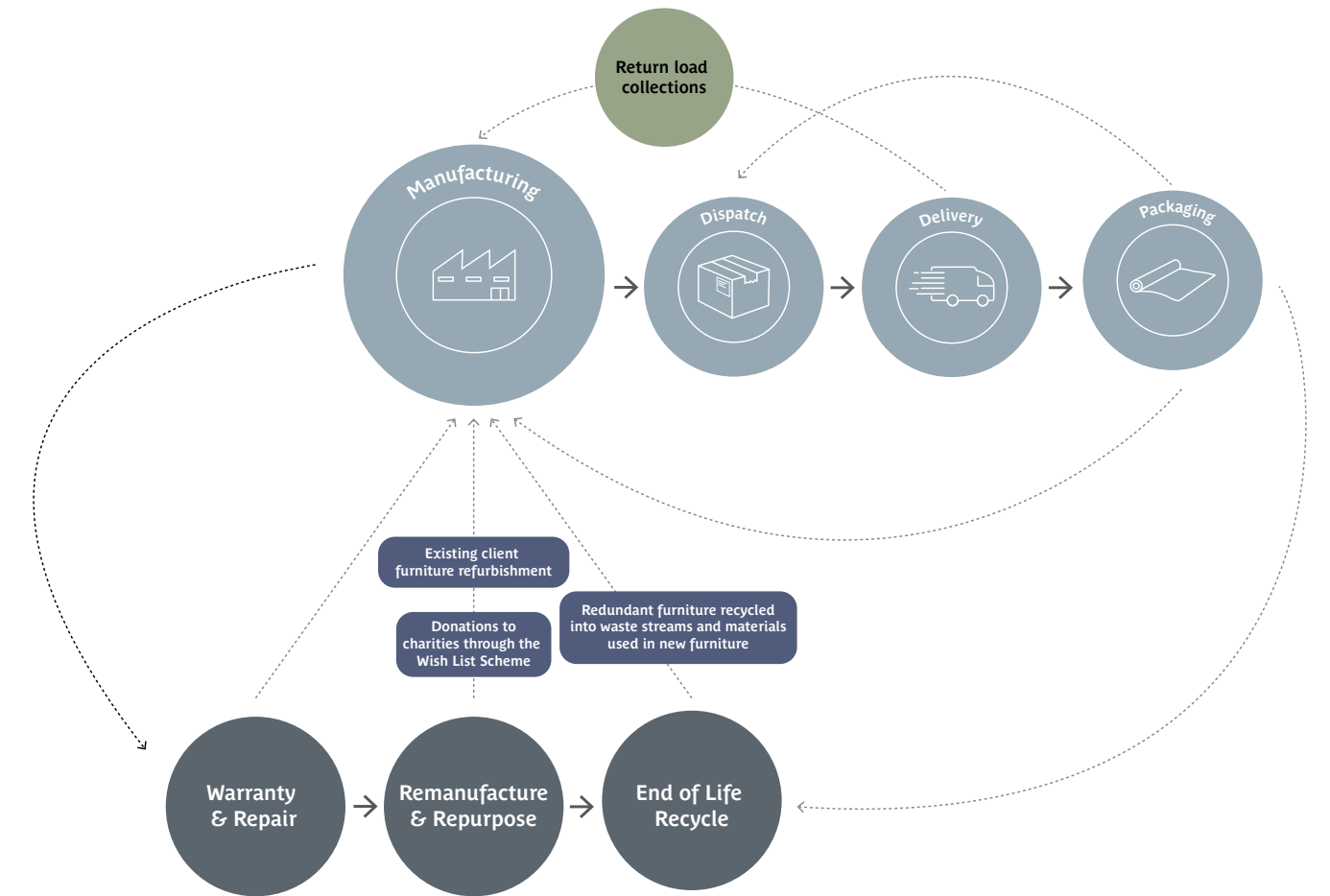

We are working with our supply chain and waste contractors to understand opportunities to further pursue a circular economy model.

Manufacturing has a huge impact on our planet, and this is why we focus each year on how we can increase the circularity of our products, incorporating materials re-use throughout our design and manufacturing process. Our in-house Sustain recycling division is a unique benefit for us, enabling us to identify waste streams that can be reused within our supply chain.

Understanding the processing and onward journey of our waste enables us to highlight opportunities for these waste streams to be re-incorporated into our processes. When we start to think of designing a new product, we consider recycled and recyclable materials wherever possible; with Sustain down the road from our factories, we can control every stage of a products life. From using fewer virgin materials right at the very start of production, to recycling and reusing our old products part by part at the very end. Ultimately this supports us in reducing our demand on raw materials and reduces the embodied carbon of our products.

Our Progress Highlights

74%
of our suppliers are
UK based.



Our company cars
have seen a
40%
reduction in emissions
over the baseline.

Our water reclamation
system has reduced
our freshwater
consumption by **85%**

85% of group
waste was
recycled.



All of our
packaging
was **100%**
recyclable.

Our commercial fleet
has achieved a 19%
saving in CO2
emissions since 2009.



We have revised our ESG strategy,
introducing three focus areas;

Designing with intent

Reducing our Impacts

and

Building Better Lives

We funded and ran two successful carbon footprint
workshops for 10 of our local suppliers,
in partnership with the Chamber Low Carbon.



We established our
first Charity and
Community Committee.



We won: **MEN business of
the Year**, **Neocon Gold** in
Collaborative Furniture for
the Adapt Wall, and **BIBAs**
'Manufacturer of the Year'

3% of energy consumed
across our UK
manufacturing sites was
from our solar panels.

Through our combined efforts,
we raised and donated over
£250,000
for our chosen charitable causes
within the last two years.

We engaged almost
1,000
employees in our
sustainability
roadshow and
generated over
150 sustainability
Bright Ideas.

Social + Value

The Senator Group are passionate about giving back to the communities in which we operate. To aid us in this, we have formed our own Charity & Community Committee.

Local Engagement

We delivered over 1,200 hours of local school engagement, working in partnership with schools in our local area to deliver a structured local school engagement plan which targeted students of all ages and backgrounds.

This involved a range of:

- School visits / Interactive sessions
- Careers fairs
- Mock interviews
- Workplace safaris
- Tree planting initiatives

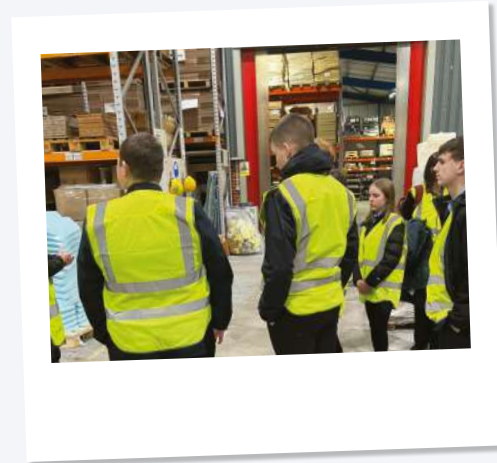

St Bede's School Case Study

One such example is St Bede's, an 11-16 mixed Roman Catholic comprehensive school situated in the west of Blackburn.

St Bede's approached Teal as a local business provider to help provide experience of the workplace for its Year 11 Design Technology and Textile students.

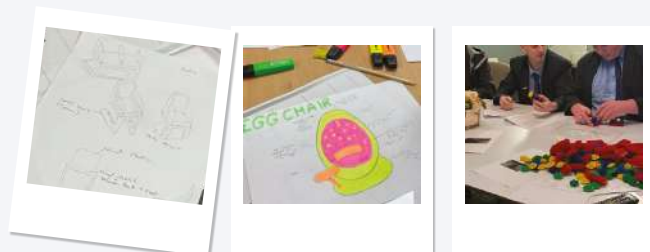

Design task with students

St Bede's Year 11 Design Technology and Textile students spent a day on site at our Head Office and manufacturing site in Lower Darwen, with activities planned throughout the day including design and lean manufacturing tasks.

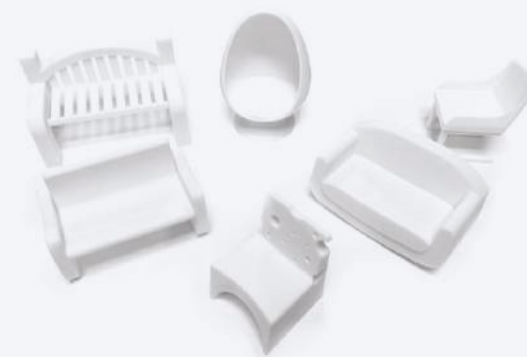

3D printed models designed by students of St Bede's

Led by our Programme Co-ordinator and the Teal Design & Development team we outlined a product brief (a piece of outdoor furniture suitable for use within a mental health environment), encouraging creativity and outside the box thinking. The final designs were 3D printed and illustrated in CAD.

[Back to contents](#)

Tree planting

We joined forces with Ribble Rivers Trust to initiate a woodland planting project – we worked together over five days to plant a staggering 15,000 trees!

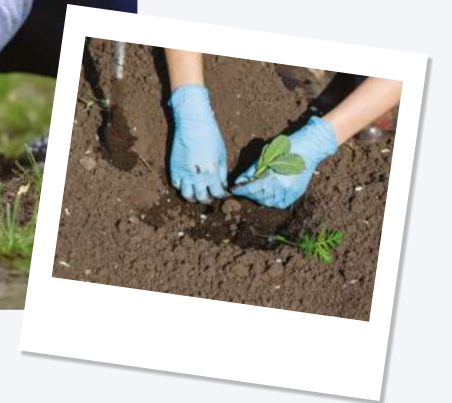

Season one of an ambitious two-phase planting project saw the planting of 15,000 trees across 30 acres of land.

Season two consisted of a further c.17,000 trees over 34 acres of land.

Charity engagement

We are experienced in delivering social value commitments, both as part of our contractual obligations and as part of our wider company CSR offering.



We have an in-house Charity and Communities Committee consisting of 14 staff members. As a business we've raised an incredible **£250k** in the last 2 years for charities, most of which was delivered in Lancashire, driving social and economic benefits.



As a sustainable partner to the NHS our own sustainability strategy is closely aligned to the NHS journey to net zero and we can therefore assist NHS Trusts, Health Boards and private providers to minimise their own environmental impact through our sustainable products and services.



Shown with Panaz Nature, a soft plant based faux leather - 209 Wasabi



We called it RENU

Made from over 99% recycled materials.

- + ROKU® RENU is created from a ground down polyethylene mix
- + Moulded products available in 99% recycled materials: ROKU® Tub chair, ROKU® table, ROKU® Keata, Button moulded Table and Button Stool
- + At least 99% recyclable at end of life
- + Only available in black finish

Recycling Redundant Furniture

Don't let your old furniture sit around. Teal offer a comprehensive removal and recycling service for redundant furniture.

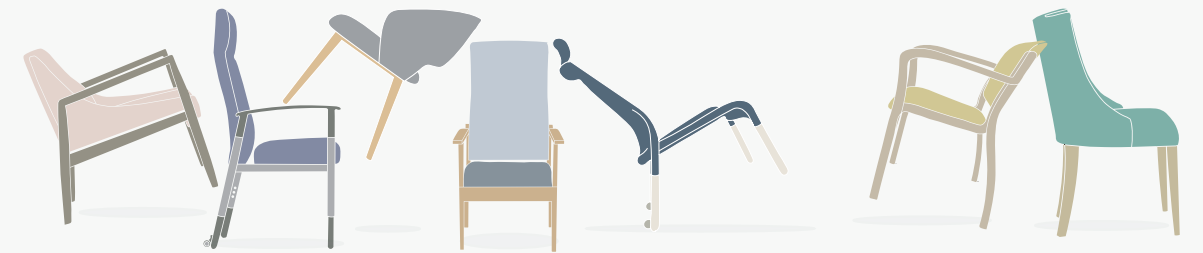

We can collect your old furniture when we deliver new.

In 2009 we developed 'Sustain', our purpose-built 15,000ft² recycling unit in Lancashire. The £1.5million facility represents a significant investment in our sustainability commitment.

Any furniture classed as redundant by customers is processed at our Sustain facility. All materials are separated, segregated and then recycled.



Flexible, reliable, fast delivery service on an extensive range of best-selling healthcare furniture, in a select range of durable, healthcare appropriate fabrics.

Visit www.teal.co.uk to view the latest products available for QuickShip Express Delivery.

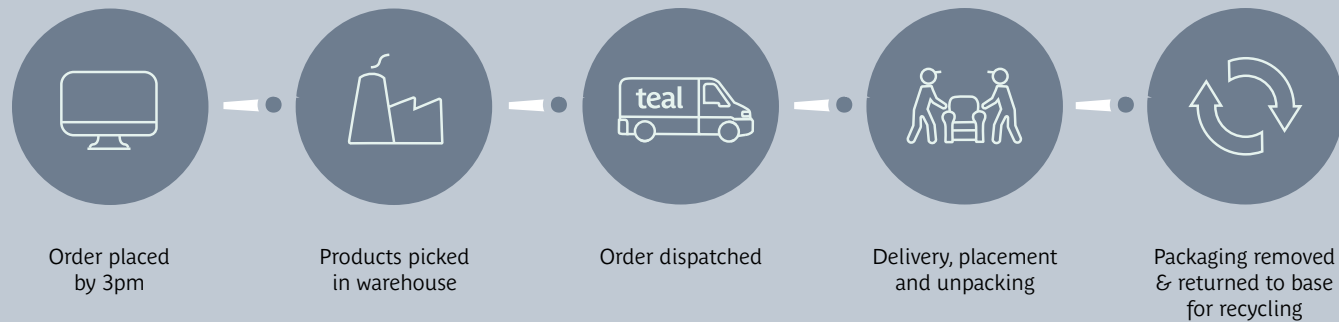

This includes delivery to a ground fl or room location. Products are unwrapped and packaging removed, ready to use.



Scan the QR code to see all available QuickShip products



Only the products / fabrics shown on our website are eligible for Express Delivery (UK mainland).



Delivery + Installation

For specialist refurbishment or new build projects Teal bring together professional project management with qualified, experienced and skilled in-house installation teams to deliver complete, on-time and in budget.

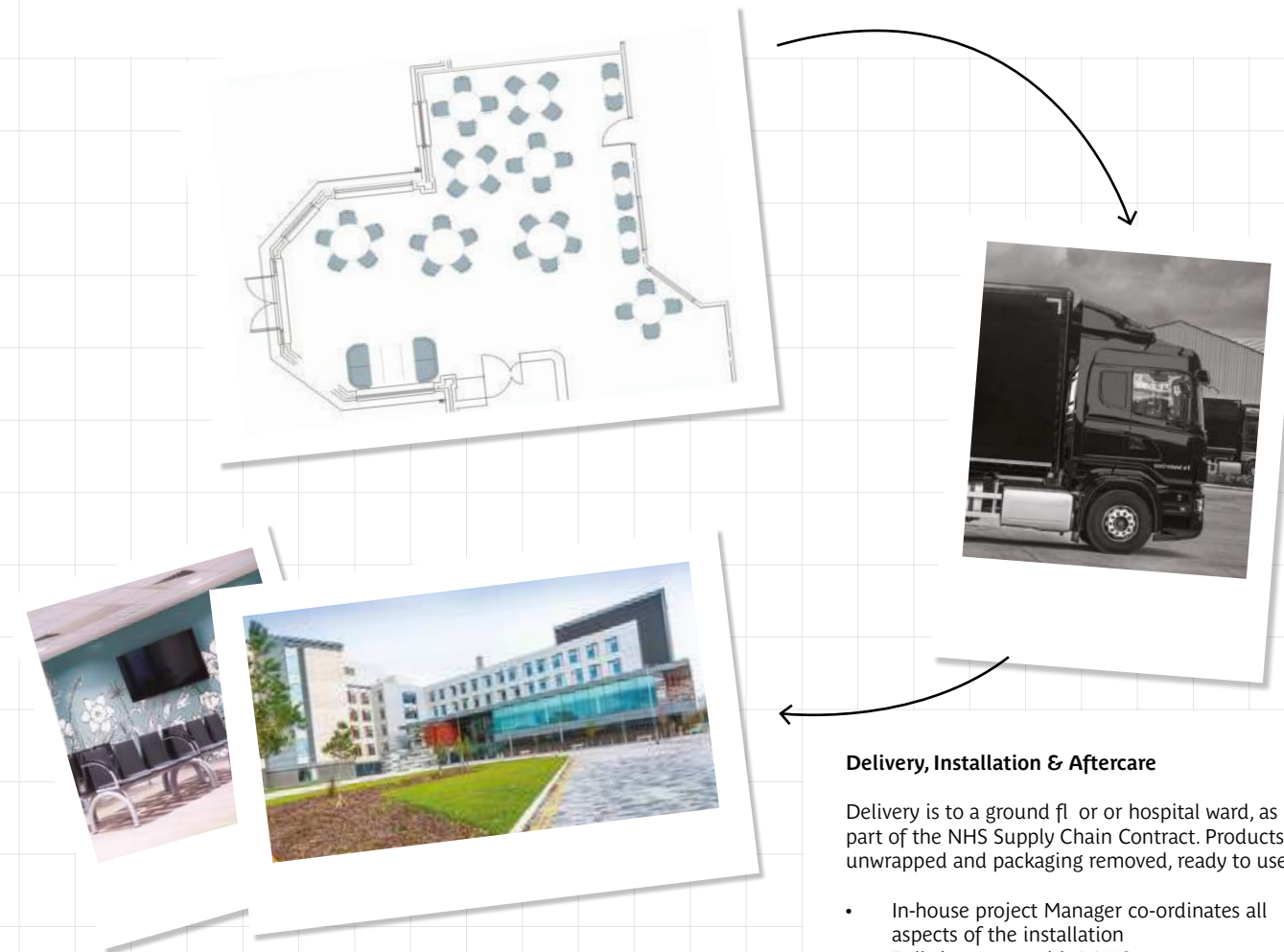

Delivery, Installation & Aftercare

Delivery is to a ground fl or hospital ward, as part of the NHS Supply Chain Contract. Products are unwrapped and packaging removed, ready to use.

- In-house project Manager co-ordinates all aspects of the installation
- Full site survey with RAMS
- Installation in line with ISO9001
- Employees CSCS & DBS approved
- Nationwide Service Support Team as part of our commitment to customer aftercare

Visit www.teal.co.uk for more information.

Teal have created a practical CAD resource to assist in the design process.

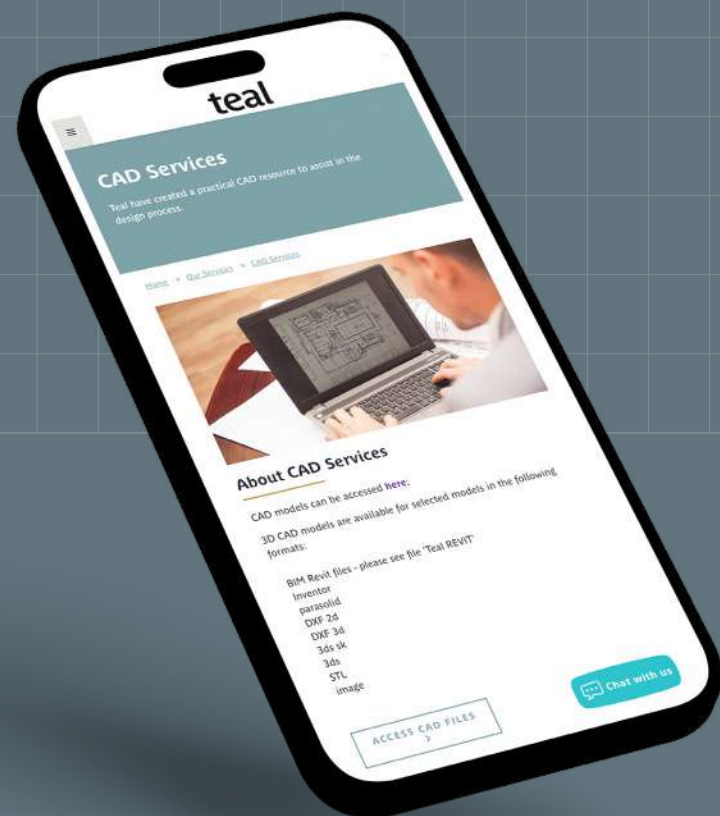

Please visit our website
www.teal.co.uk
to access all CAD models.
Available in 2D, 3D and Revit.

Discover our Medical Equipment & Solutions for Challenging Environments Brochures online today at www.teal.co.uk!

Medical Equipment

A range of Medical Equipment designed for clinical settings, including hospitals, clinics and care homes.

Designed for demanding high traffic healthcare environments our ranges include sterilisation furniture, transport trolleys, shelving & storage, operating room furniture, height-adjustable stools, waste & linen management, examination & consultation equipment and Eolis® modular trolleys - fully customisable, with multiple options available to meet clinical needs.



Solutions for Challenging Environments

Teal LifeCare furniture collections are designed to meet the specific requirements of a broad spectrum of challenging environments, ranging from high and medium secure forensic services through to rehabilitation, step down and special educational settings.

Working directly with key stakeholders within the Royal Liverpool Procurement Team and with NHS Shared Business Services Teal provided a selection of specialist healthcare furniture throughout the new 640-bed facility.



Charlotte



Cascade Plus



Astra

Products included 'Cascade Plus' – a bespoke extra-large bedside locker developed specifically for patients at the new Royal, providing easy, safe and secure care of patient valuables and medications. Staff and patients will also benefit from Teal's specialist patient seating and recliners, together with ergonomically designed and comfortable seating for bariatric care.

Teal Healthcare supplied its specialist furniture throughout the Grange University Hospital, a spectacular £350m hospital in Llanfrehfa, South Wales.

Part of Aneurin Bevan University Health Board's plan to restructure health care across Gwent, the hospital has been equipped with Teal's patient seating, waiting and atrium seating, specialist recliners and provision for relatives overnight stays with the inclusion of Buddy attendant chair / day beds and Moby sofa beds.



Anne

Astra



Orion

Southern Housing

St Peter's Hospital, Chertsey

Built over three floors, Nightingale Avenue offers the very best in keyworker accommodation, provided in self-contained 'cluster flats' designed for between 2 and 4 person occupancy, with communal kitchen / diner and en-suite rooms.

Built over three floors, Nightingale Avenue offers the very best in keyworker accommodation, provided in self-contained 'cluster flats' designed for between 2 and 4 person occupancy, with communal kitchen/diner and en-suite rooms.

It also offers 1 bed self contained flats. And with space for 132 occupants the stylish new homes incorporate key design features developed specifically for Southern Housing, including bespoke wardrobes, desks and shelving, as well as seating, window dressings, white goods, mirrors and accessories supplied and installed by Teal HealthCare.

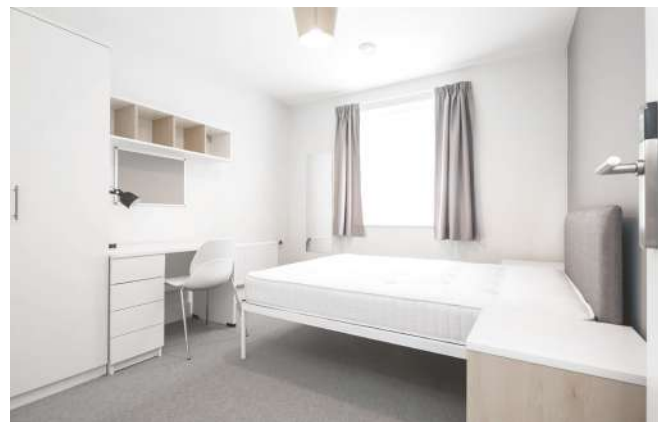
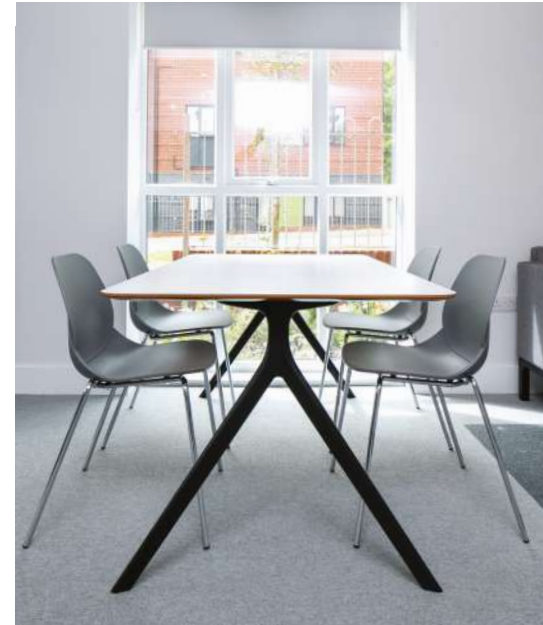

The Southern Housing team chose Teal as a design partner on this landmark project following a competitive tender to provide full FF&E, including furniture and household items. Southern Housing were determined to offer a full 'step into home' service, and felt this could be achieved with Teal's best-in-class product and UK manufacturing expertise.

Teal successfully delivered a high quality and flexible living environment, supporting Southern Housing's design vision and 'enhancing lives' philosophy.

The overall design of the accommodation is contemporary, using modern materials and technology, perfectly suited to the large range of products and styles available from the Teal Key worker accommodation portfolio.

Furniture and decor work in-line with Southern Housing's 'Keyworker Design Statement' and colour choices, with a fresh colour palette and a mixture of modern seating, dining and bedroom spaces.

Teal worked alongside the appointed contractor 'United Living' and provided full project management, delivery and installation throughout this prestigious new build project.



NHS

Bassetlaw Hospital

Teal Healthcare has equipped a brand-new state-of-the-art facility at Bassetlaw Hospital with its specialist healthcare furniture, as part of the phased transition of urgent, acute, and paediatric services at the hospital.



The waiting area within the Emergency Department features Adeo beam seating, co-ordinating beautifully with the feature wall, with its eye-catching bespoke floral artwork helping to create a welcoming and uplifting experience. Adeo is particularly suited to high traffic waiting and outpatient areas with its comfortable soft PU seats and in-built anti-bacterial technology helping clinicians to maintain hygiene levels.

The complex is located directly in front of the Hospital's main entrance and delivers a more efficient patient flow throughout the hospital, helping to improve the patient experience, while also enhancing the environment for healthcare professionals in the delivery of care.

Designed to improve the patient environment the new facility is part of a drive to enhance healthcare services for communities across Bassetlaw and North Nottinghamshire.

The £7.6m contract to build a new Emergency Care Village for Doncaster and Bassetlaw Teaching Hospitals NHS Foundation Trust (DBTH) starts the transition of paediatric, urgent and acute services, ensuring that for the first time, all emergency assessment facilities are now in one place.

Following a comprehensive consultation process the scheme was designed with due consideration for comfort and neurodiversity, with construction partners, clinicians and the local community involved in years of careful planning.

The Hospital's Acute Medical Unit (AMU), Major and Resuscitation services within the Emergency Department (ED) and Children's Assessment Unit (CAU) have all moved into the new building. The new Children's Assessment Unit benefits from Teal's Astra Galaxy bedside recliners, ensuring family members can sit and relax comfortably next to their child's bed, while Affiniti bedside lockers ensure safe storage of medication and patient valuables.



Fabric+Matrix

Teal source contract fabrics from market leading manufacturers. Durable and resistant to abrasion, a range of fabrics are available to meet the specific demands of challenging environments. Many are stain resistant, waterproof and have anti-microbial, anti-fungal properties to help reduce the risk of healthcare associated infections.

Supplier	Range	Use: H = Hospital C = Care facility G = Gen reception	Contract Group	Type: F = fabric V = vinyl	Crib 5	Crib 7	Stain Resistant	Anti-Bacterial	Anti-Microbial	Water Resistant	Bleach Clean	Anti-Graffiti
Agua	Paint Pot (Faux Leather)	H	2	V	•		•	•	•	•	•	
Camira	Xtreme +	G	2	F	•			•				
Panaz	Cadet Colours - Zest	H	2	V	•		•	•	•	•	•	
Agua	Fleck	H	3	V	•		•	•	•	•	•	
Agua	Juno	C	3	F	•		•	•	•	•	•	
Agua	Linetta	C	3	F	•		•	•	•	•	•	
Agua	Lunar	H	3	V	•		•	•	•	•	•	
Agua	Parody Linen	H	3	V	•		•	•	•	•	•	•
Agua	Taurus	H	3	V	•		•	•	•	•	•	
Camira	Mainline Plus	G	3	F	•			•				
Camira	Vita	H	3	V	•		•	•	•	•	•	
Chieftain	Just Colour + Just Patterns	H	3	V	•		•	•	•	•	•	
Dartex	Pressure Care 4 x Stretch	H	3	V	•		•	•	•	•	•	
Iliv	Nevis	H	3	V	•		•	•	•	•	•	
Panaz	Alba	C	3	F	•		•	•	•	•	•	
Panaz	Aston (Faux Leather)	H	3	V	•		•	•	•	•	•	
Panaz	Brookland	H	3	V	•		•	•	•	•	•	
Panaz	Highland	C	3	F	•		•	•	•	•	•	
Panaz	Marna	C	3	F	•		•	•	•	•	•	
Panaz	Tweedy	H	3	V	•		•	•	•	•	•	
Spradling	Valencia	H	3	V	•		•	•	•	•	•	
Agua	Argentex	C	3+	V	•		•	•	•	•	•	
Agua	Cashmir	C	3+	F	•		•	•	•	•	•	
Agua	Entwine	C	3+	V	•		•	•	•	•	•	
Agua	Nova	C	3+	F	•		•	•	•	•	•	
Agua	Primeira	C	3+	F	•		•	•	•	•	•	
Agua	Sark	C	3+	F	•		•	•	•	•	•	
Agua	Tones	C	3+	F	•		•	•	•	•	•	
Ambla	Berkshire/ Richmond, Munro, Wild Heather, Tinto	H	3+	V	•		•	•	•	•	•	
Boyriven	Enduralex with Forbid anti graffiti	H	3+	V	•		•	•	•	•	•	•
ILIV	Lismore	C	3+	V	•		•	•	•	•	•	
ILIV	Q1898 Printed (Base Cloth)	C	3+	F	•		•	•	•	•	•	
ILIV	Q2099 Printed (Base Cloth)	C	3+	F	•		•	•	•	•	•	
Panaz	Cadet Soft Touch Pro (PVC)	H/C	3+	V	•		•	•	•	•	•	
Panaz	Eve	C	3+	F	•		•	•	•	•	•	
Panaz	Haven (Outdoor/Indoor)	C	3+	V	•		•	•	•	•	•	
Panaz	Highland Matte Stretch	C	3+	F	•		•	•	•	•	•	
Panaz	Highland Printed	C	3+	F	•		•	•	•	•	•	
Panaz	Luxe Performance Velvet	C	3+	F	•		•	•	•	•	•	
Panaz	Luxe printed	C	3+	F	•		•	•	•	•	•	
Panaz	Vyflex Plus Stretch	H	3+	V	•		•	•	•	•	•	
Panaz	Westwood - Hugo/Karl print*	C	3+	F	•		•	•	•	•	•	
Skopos	Chamonix - Orelle & Slalom	C	3+	F	•		•	•	•	•	•	
Skopos	Moritz - Casper, Cresta, Luge & Orelle	C	3+	F	•		•	•	•	•	•	
Vescom	Creek	H	3+	V	•		•	•	•	•	•	
Vescom	Furka +	H	3+	V	•		•	•	•	•	•	
Vescom	Jemo	H	3+	V	•		•	•	•	•	•	
Vescom	Scott, Arrow, Dalma, Cyprus, Malta	H	3+	V	•		•	•	•	•	•	

*Requires base cloth

See latest fabric matrix at www.teal.co.uk

[Back to contents](#)

Supplier	Range	Use: H = Hospital C = Care facility G = Gen reception	Contract Group	Type: F = fabric V = vinyl	Crib 5	Crib 7	Stain Resistant	Anti-Bacterial	Anti-Microbial	Water Resistant	Bleach Clean	Anti-Graffiti
Agua	Boucle	C	4	F	•		•	•	•	•	•	
Agua	Eden	C	4	F	•		•	•	•	•	•	
Agua	Stretch (Weldable)	H	4	V			•	•	•	•	•	
Agua	The 7 Collection (Crib 7)	H	4	V		•	•	•	•	•	•	
Camira	Halcyon - Aspen, Blossom, Cedar	C	4	F	•		•	•	•	•	•	
Panaz	Chayton Collection	C	4	F	•		•	•	•	•	•	
Panaz	Woolton plus printed	C	4	F	•		•	•	•	•	•	
Skopos	Bonita	C	4	F	•		•	•	•	•	•	
Skopos	Chamonix - Marmotte	C	4	F	•		•	•	•	•	•	
Skopos	Moritz - Bernina	C	4	F	•		•	•	•	•	•	
Skopos Herriot	Bennet, Hughes, Phinn, Priestley	C	4	F	•		•	•	•	•	•	
Spradling	Avantgarde	H	4	V		•	•	•	•	•	•	
Spradling	Silververtex	H	4	V	•		•	•	•	•	•	
Lindhurst	Sileather Premier & Original	H	5	V	•		•	•	•	•	•	•
Sunbury	Stylecare 4 range, Barton, Fleming, Jemison,	C	5	F	•		•	•	•	•	•	
Panaz	Graphics - Viva	C	POA	F	•		•	•	•	•	•	
Ultrafabrics	Ultraleathers	G	POA	V	•							
Yarwood	Style Leather	G	POA	L	•							

Please contact Teal Customer Services for help in the selection of a suitable fabric for your environment.

The following fabrics are suitable for fully sealed complete upholstery:
We are continually testing fabrics for suitability for complete upholstery. Please contact Customer Services for the latest list.

Supplier	Range	Use: H = Hospital C = Care facility G = Gen reception	Contract Group	Type: F = fabric V = vinyl	Crib 5	Crib 7	Stain Resistant	Anti-Bacterial	Anti-Microbial	Water Resistant	Bleach Clean	Anti-Graffiti
Panaz	Cadet Colours - Zest	H	TP2	V	•		•	•	•	•	•	
Agua	Fleck		TP3	V	•		•	•	•	•	•	
Agua	Taurus	H	TP3	V	•		•	•	•	•	•	
Agua	Parody Linen	H	TP3	V	•		•	•	•	•	•	
Panaz	Aston (Faux Leather)	H	TP3	V	•		•	•	•	•	•	
Panaz	Darcy		TP3	F	•		•	•	•	•	•	
Panaz	Marna	C	TP3	F	•		•	•	•	•	•	
Panaz	Brookland	H	TP3	V	•		•	•	•	•	•	
Panaz	Vintage		TP3	V	•		•	•	•	•	•	
Agua	Nova	C	TP3+	F	•		•	•	•	•	•	
Agua	Sark	C	TP3+	F	•		•	•	•	•	•	
Camira	Halcyon	C	TP3+	F	•		•	•	•	•	•	
Panaz	Haven (Outdoor/Indoor)	C	TP3+	V	•		•	•	•	•	•	
Panaz	Riva		TP3+	F	•		•	•	•	•	•	
Agua	7 Collection (Crib 7)	H	TP4	V		•	•	•	•	•	•	
Chieftain	Protect 7		TP5	V	•	•	•	•	•	•	•	
Lindhurst	SiLeather	H	TP5	V	•		•	•	•	•	•	•

Please contact Teal Customer Services for help in the selection of a suitable fabric for your environment.

See latest fabric matrix at www.teal.co.uk

Care & Maintenance of Healthcare Vinyl Upholsteries

Fabric selection

Teal offer a wide range of vinyl/faux leather and fabric upholsteries from all the leading fabric manufacturers which meet the required healthcare criteria.



General Care & Maintenance

Vacuum or wipe vinyl clean regularly and routinely with a microfibre cloth lightly dampened with cool water to remove dust and particles. Dry with a clean absorbent cloth.

Caution:

Steam cleaning:

Use in strict accordance with manufacturer's guidelines. Heat from steam cleaning disinfects but may permanently "cook in" protein stains.

Too much heat applied for too long may damage the PVC.

Antimicrobial Fogging:

Most vinyl will withstand occasional antimicrobial fogging. However, allowing residues to remain and accumulate on the vinyl surface may cause irritation to skin and long term damage to the upholstery.

Crocking:

Dyes and inks are intended to be indelible and will permanently mark fabric. Please note that all upholstery fabrics may be subjected to fabric crocking.

Crocking is the transfer of dye from one fabric to another. This may be caused by excess dye, improper dyeing methods or poor heat curing on jeans, trousers, dresses and skirts.

If crocking is noticed straight away, depending on the dye on the offending garment, crocking may be removed with mild alkali free soap and cold water. However, crocking sets if not immediately addressed. If crocking is a concern, select a mid or dark colourway for upholstery.

Vinyl

Vinyl and faux leathers are trusted for all areas of clinical care.

They combine:

- Robustness to cope with high traffic in busy healthcare environments.
- Flame retardancy treatments to retard flame where people come together to work or relax in numbers.
- Impervious nature keeps foams dry and clean.
- Antimicrobial protection renders the vinyl functionally active to inhibit the growth of hazardous microbes, creating an added layer of defence and prolonging the life of the vinyl
- Improved stain resistance allows more time to remove spillages and soiling to prevent staining.
- Ease of cleaning and resilience to infection control cleaning protocols and chemicals.

Spillages and Stains

Most spillages or stains can be simply wiped clean provided they are addressed promptly – within 15 minutes. Stains become harder to remove the longer they sit, particularly if subjected to body heat. Hot water can set protein-based stains, such as blood. It can cook proteins, causing them to bond with the vinyl surface. Therefore, it's essential to avoid hot water for these types of stains. Simply wipe the stain with an absorbent dry cloth and clean with a microfibre cloth lightly dampened with cool water.

Infection Control

Remove body fluids and extreme soiling immediately (within 15 minutes) with cold water. Apply approved infection control protocol: e.g., 5% sodium chlorite bleach solution, Haz Tabs, Chlor Clean, Tristel Fuse, etc. Remove chemical residue from vinyl surface and dry with a clean absorbent dry cloth.

Allowing cleaning product residues to accumulate on vinyl surface can create an irritant to skin and damage the upholstery. Wipe clean and remove surface residues routinely.



Wood Finish Options

Wood Grain Finishes:



Kendal Oak (KO)
LRV: 34



Lancaster Oak (LA)
LRV: 27



White Oak (HW)
LRV: 48



Natural Halifax Oak (HN)
LRV: 35



Tobacco Oak (HT)
LRV: 21



Shorewood (SD)
LRV: 24



Natural Beech (NB)
LRV: 38

Flat Finishes:

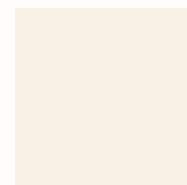

White (WH)
LRV: 74



Cashmere (CE)
LRV: 50



Cobble Grey (CG)
LRV: 57



Cream (CR)
LRV: 81



Duck Egg (DE)
LRV: 30



Midnight Blue (MN)
LRV: 3

Colour Disclaimer: Printed images and digital images may appear differently to the final finish.

Designing for Wellbeing & Dementia



Dementia affects all areas of life

It has both a physical and emotional impact. It invades mood, corrodes confidence and increases anxiety levels. Moreover, it affects vision, hearing, balance, special awareness, strength and orientation.

Thoughtful intuitive design can help to mitigate these perceptions and plays a crucial role in enhancing the lives of people affected by dementia and maximising independence by:

- Providing an environment which is accessible, safe, navigable by unobtrusively reducing risk, for example from falls, by careful considered circulation routes and furniture placement.
- Using familiar decorative accessories or furniture as “Memory Cues” in strategic locations to facilitate orientation and mobility.
- Using lighting; whether Ambient, Task or Accent, to mitigate poor vision and the confusion and anxiety it creates in people living with dementia.

- Promoting natural light and avoiding blinds and window obstructions. Installing curtains to the very outer edge of windows to minimise light blocking.
- Using Light Reflective Values as a tool to establish contrasting differences of approximately 30 for colours on adjacent surfaces to aid visibility whilst creating a calm but attractive spaces.
- Using flooring design and colour to either encourage or discourage access to areas. Avoiding highly contrasting colours in irregular, busy or geometric patterns. Using plain materials to avoid confusion and textures to create interest and stimulation.
- Using some absorbent finishes such as upholsteries, curtains, textured wall coverings and some soft flooring to reduce noise and the resulting distress sudden, loud sounds can cause.

Designing for Dementia - Core Considerations

Teal focus on 4 core areas of concern when designing seating for elderly care and, specifically, people living with dementia:

- Access and mobility with emphasis on ease of sitting and raising to encourage mobility.
- Promoting best posture and its impact on wellbeing: alleviating neck and back pain, facilitating respiratory function, improving circulation and brain function, etc.
- Cleanability and infection control promoting a safe environment free of cross contamination.
- Visibility and Safety, offering large ranges of patterned, plain and textured upholsteries to enable the application of Light Reflective Values of 30.

The form and structure of seating for people living with dementia is much the same as for elderly in general.

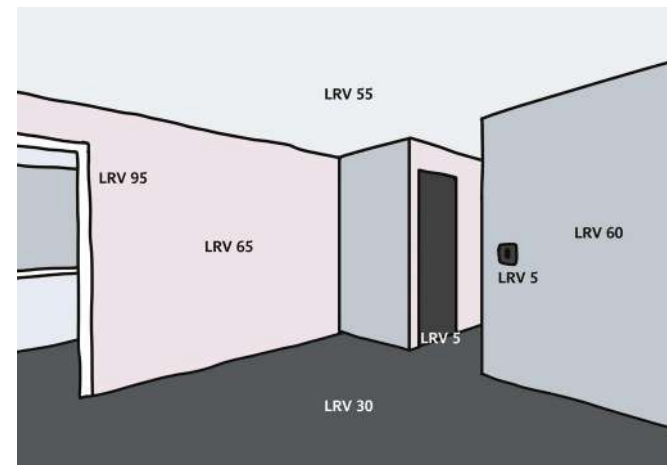

Light Reflective Values (LRV)

Access, mobility & posture

Access and mobility

The impact of mobility limitation on health outcomes is well documented. Keeping active is important for everyone but particularly so for the elderly and those living with dementia. Regular physical activity has been associated with:

- Better cognitive function and reduced risk or speed of decline of dementia.
- Maintained blood flow to the brain, supporting neuroplasticity and reducing inflammation.
- Reduced risk of weakened muscle strength (Sarcopenia)

Encouraging and facilitating mobility is core to Teal design strategy, allowing as much movement and independence as possible. The inability to stand up from a chair aligns with the risk of falls and frailty. When seating is too low, the sit/stand transition is onerous. This not only makes standing more difficult, it can discourage mobility, cause anxiety and, as stated above, create a falls risk.

The design of seating is paramount. Seat heights, depths, form and features (such as head rest, arm shape and height) are all important.

When seating is too high and feet are not securely planted on the ground, supporting and distributing weight, then our posture and tissue viability is compromised. Teal offer a range of seat heights to provide flexibility and compromise between the demands of mobility and tissue viability.

Posture

Our spines change as we age. The vertebrae and discs that act as cushions between the bones of our back begin to break down and thin over time. The cartilage and connective tissues lose thickness and elasticity. Good posture can help minimise discomfort and pain.

Moreover, maintaining the correct upright posture (a neutral spine), improves blood flow to the brain, enhancing focus, memory, overall brain health and prevents digestive issues.

Proper posture is supported by good seating design with correct seat depth, arm heights, supportive chair backs and headrests.

The correct arm height in relation to seat height provides comfort and support and ensures that elbows too can assist in distributing weight and aiding posture. Furthermore, they are central to assisting standing. If arms are not at an appropriate height, the sitter relies on weakened hand muscles to pull themselves up. If the arm is suitably situated on the chair arm, the sitter can use both elbows and hands to leverage their weight. Essentially, the arms create a “push off” to standing position.

Comfort is further enhanced by appropriate cushion foams: such as comfort foam, BB medium-high risk and CC high risk foams to provide appropriate pressure distribution and comfort.

Cleanability & infection control

This is achieved by maximizing access to all areas of seating for cleaning. Upholsteries should be appropriate healthcare specific impervious fabrics which have recognized healthcare features.

Features include:

- Robustness and durable to cope with high traffic in busy healthcare environments.
- Flame retardancy treatments to retard flame and allow people time to exit the property.
- Water proofing to protect foam seat pads.
- Antimicrobial protection renders the fabric functionally active to inhibit the growth of hazardous microbes, creating an added layer of defence and prolonging the life of the fabric.
- Improved stain resistance allows more time to remove spillages and soiling to prevent staining.
- Ease of cleaning and resilience to infection control cleaning protocols and chemicals.



Safety and visibility, with assessment of fall risk

We lose the ability to see and differentiate colour as we age. Pale colours merge into porridge shades and medium tones of blues / purples / greens etc can read as grey. Hence, the degree of contrast between adjacent surfaces is an important aid for the visually impaired in distinguishing between surfaces.

For people without dementia or those who are partially sighted, lack of surface contrast is a major difficulty. However for people living with dementia, it is not only difficult but desperately confusing, creating unnecessary anxiety and depression.

Teal offer a huge range of plain and textured upholsteries to facilitate contrast, achieving 25-30 LRV differential to ensure that seating is visible to the partially sighted and discernible for people living with dementia.

Ergonomically designed patient seating ranges with all the comfort and functionality required for high intensity traffic in ward and departmental areas.

A range of standard and optional features focus on five major criteria of ward seating: infection control, tissue viability, manual handling, patient safety and comfort.



To suit patients' varying postural needs, options include seat height adjusters and removable 2 depth seat adjustment plus pressure distributing seat for a holistic approach to pressure management. In addition, housekeeping wheels assist manual handling.



Multiple vinyl / fabric upholstery options & colours available
see pages 30-31 for further information

Patient+ Seating

Tolero



Tolero PSTL02 high back chair with height adjustable legs

The Tolero metal patient chair demands attention by virtue of its slimline profile, contemporary form and a host of unrivalled features for infection control, tissue viability and manual handling, including: removable seat, Reflexion® high risk pressure distributing seat, housekeeping wheels and integral adjustable legs (PSTL02 / 03 / 05 / 06 models).



PSTL01 Tolero
High Back Chair



PSTL02 Tolero
High Back Chair,
Integral Height Adjustable Legs

PSTL21 Tolero
Fixed Height Footstool

PSTL22 Tolero
Height Adjustable Footstool

PSTL23 Tolero
Height Adjustable Pedestal Footstool

Standard Features

- Strong, durable high grade steel frame creates a modern aesthetic
- Modern, slim profile with contoured back mimics curvature of spine for constant support
- Elegant moulded black plastic arms and extruded frame with integral anti-bacterial technology
- Removable depth adjustable seat (2 positions) for cleaning / access
- Easy clean polymer moulded seat base (removable seat only)

- Reflexion® BB medium / high risk pressure management seat
- Sacral gap as standard for cleaning/infection management
- Ergonomically positioned arms for easy sit to stand transition
- Integral housekeeping wheels as standard
- Resilient to commonly used healthcare cleaning systems
- Maximum user weight: 160kg (25st)
Bariatric user weight 320kg (50st)
- Black arms as standard (All models)

Options

- Frame finish options
- Fixed seat
- CC Gel seat (see page 60)
- Matching Tolero Beam & Bench seating available (See pages 128-131)
- Wide range of upholstery finishes (see pages 30-31)

Frame colour options:

- Stone
- Onyx
- Anthracite



Tolero Drop Arm



Tolero PSTL03 high back chair with drop arms

Tolero Mid Back



Tolero Mid Back shown in comparison to High Back model



PSTL04
Tolero Mid Back Chair

PSTL05
Tolero Mid Back Chair,
Height Adjustable Legs



PSTL06
Tolero Mid Back Chair, Drop Arms,
Height Adjustable Legs

Tolero Bariatric



PSTL07 Tolero
High Back Bariatric Chair

PSTL08 Tolero
High Back Bariatric Chair,
Drop Arms

Bariatric user weight 320kg (50st)



PSTL03 Tolero
High Back Chair, Drop Arms,
Height Adjustable Legs



PSTL06
Tolero Mid Back Chair, Drop Arms,
Height Adjustable Legs

Mobility is a fundamental aspect of patient care in nursing, crucial for both physical health and psychological Wellbeing.

Drop arm seating ensures patients can move safely and comfortably from a bed to a chair, or wheelchair.

The drop-arm chair has a full range of standard features and is available in both high and mid back.



Slim profiled back



Pressure care seat



Sacral gap

Tolero Standard Features



Removable Seat

Removable seat with polymer base facilitates cleaning and infection control.



Adjustable Seat Depth

Adjustable seat allows 2 depths ensuring support from the chair back without cutting off circulation at the knees.



Pressure Care Seat

Reflexion® BB medium / high risk pressure management seat. Standard on all models.

Reflexion® CC high risk pressure management seat option also available (see page 60).



Height Adjustable Legs (Model Specific)

A range of chair heights provide appropriate seating height and bring benefit to posture, circulation, balance on rising and core strength. Image shows minimum height. In 25mm increments.



Ergonomic slim profiled back

Slim profile with contoured moulded back mimics curvature of spine for constant support.



Easy Rise Arms

The ability to stand from a sitting position is key to maintaining mobility, independence, and is an important factor for patients.



Sacral Gap

Sacral gap for ease of cleaning and access.



Housekeeping Wheels

Housekeeping wheels facilitate manual handling. Housekeeping wheels standard on all models.

Tolero Options



Fabric & Finish Colour Options

Onyx, Anthracite & Stone finish options. Wide range of contact fabric options available.



Removable Seat Platform

Interchangeable seat platform allows safe use of prescribed bespoke or dynamic pressure cushion without slips or falls from existing cushion or changing seat height. (See page 61 for full details).



Replaceable Seat & Back

Replacement parts available for whole life costs. A sustainable solution that extends the product lifecycle.

Additional Model Options:



Bariatric Model Options

Maximum user weight 320kg (50st). (See page 66 for details).



Drop Arm Model Options

Drop arms allow for ease of patient transfer. (See page 40 for details).



Mid Back Model Options

Mid back models available (200mm lower than high back). (See pages 40 - 41 for details).

Matching Tolero Beam & Bench Seating available:



Beam Model Options

(See pages 128 - 129 for details).



Bench Model Options

(See pages 130 - 131 for details).

Manual Handling

Manual handling procedures seek to minimise the risk of injury from hazardous manual handling in the workplace, the root cause of more than a third of all workplace injuries with the following consequences:

Immediate Consequences:

- Broken bones from falls and dropping objects
- Pulled muscles from over exertion during lifting or moving tasks
- Sprains due to incorrect handling techniques
- Cuts, bruises and breaks from accidental collisions while handling patients and object

Long-Term Consequences:

- Repetitive Strain Injury – a chronic condition; the gradual and cumulative wear and tear to muscles, ligaments, tendons, joints, bursa and nerves caused by repetitive incorrect practices
- Potential degenerative conditions (for example Carpal Tunnel Syndrome) due to inadequate lifting / moving practices
- Reduced quality of life: dignity, wellbeing and mental health compromised during inaccurate and inappropriate handling tasks.

Manual handling incidents within diverse healthcare facilities have significant consequences for both staff and patients.

This impact is both human, as noted above, and financial; the cost to the NHS of patient handling related sickness, at a time when the NHS is trying to achieve major savings over £400 million each year.

Injury Risk:

Teal's design policy approaches manual handling from the perspective of both the patient and healthcare worker prioritising the needs and comfort of the end user with due consideration to their capabilities, strength and any limitations with consideration of:

- **Ergonomics Focus** on Posture and Tissue Viability: e.g., overall height, reach, arm height. Proper ergonomics allow patients to sit and rise with ease, promoting comfort and mobility.
- **Grip and Surfaces** with features such as:



1. Robust housekeeping wheels and castors with a smooth glide for easy mobility



2. Effective braking features – locks to prevent unintended movement when furniture is stationary



3. Removable or drop arms (to one or both sides) to aid patient transfer



4. Sleek, minimal design to avoid trip hazards



5. Clear load bearing – specified maximum weights



6. Easy rise arms



7. Easy clean surfaces resilient to infection control protocols

Features & Accessories



Removable Seat

- Upholstered onto rigid plastic platform
- Two seat depth adjustments
- Wipe down for hygiene control



Adjustable Seat Depth

- Adjustable seat allows 2 depths ensuring support from the chair back without cutting off circulation at the knees (standard on Aylesbury models, optional extra on other patient seating models).



Pressure Care Seat

- Reflexion® BB medium / high risk pressure management seat option. Standard on all Whittle bariatric models.

Reflexion® CC high risk pressure management seat option also available. (See page 60).



Height Adjustable Legs

- Leg adjustment of up to 100mm (added to lowest seat height offered).



HARW

- Seat height adjusters with housekeeping wheels. Height adjustment / improved mobility.



Height Options

- Standard seat height is 19" (480mm). All our patient seats can be specified with 16", 17", 18" fixed seat heights (405, 430, 460mm), except drop arm models (minimum 17").

Please contact Teal Customer Services to confirm requirements.



BC Braked Castors

- Fits most patient seating.



Housekeeping Wheels

- Housekeeping wheels facilitate manual handling. Fits most patient seating.

Perry



Perry 730 High back patient chair shown with Cascade BLCC21 Bedside locker and Perry 743 High back chair with drop arms

A durable seating range with a classic aesthetic and multiple options focused on patient wellbeing.



Winged Back

Armpads

Standard Features

- Ergonomically designed head and lumbar support optimise posture
- Ergonomically positioned arms for easy sit to stand transition
- Sacral gap aids cleaning and infection management
- Resilient to standard infection control cleaning protocols
- Maximum user weight 160kg (25 stone)
- Medicote™ technology for antimicrobial finish assists infection control

Optional Features

- Reflexion® (BB) pressure management seat and Gel (CC) seat options (see page 60)
- Height adjusters
- Removable, depth adjustable seat
- Removable seat platform for use with dynamic pressure cushion (see page 61)
- Wide range of upholstery finishes (see pages 30-31)
- Range of wood finishes



730 Perry
High Back Chair



743 Perry
High Back with Drop Arms



732 Perry
Mid Back chair

743N Perry
Upholstered Drop Arm
Armpads (inset)



730WAI Perry
Wings, Armpads and
Upholstered Sides



780
Footstool

730W Perry
Wings only

Options

See page 45 for all Features & Accessories

Highly durable, multi-option patient seating family designed for ultimate patient wellbeing.

Wood Finish Options



Aylesbury



Aylesbury 830 High Back Patient Chair shown with Infiniti OBIN02 Overbed Table

Bedside patient seating range with removable seat as standard and Reflexion® pressure management seat options.



830 Aylesbury
High Back chair



843 Aylesbury
High Back chair
with Drop Arms



832 Aylesbury
Mid Back Chair

Options

See page 45 for all Features & Accessories

Standard Features

- Ergonomically designed head and lumbar support optimise posture
- Ergonomically positioned arms for easy sit to stand transition
- Removable, depth adjustable seat
- Sacral gap aids cleaning and infection management
- Resilient to standard infection control cleaning protocols
- Maximum user weight 160kg (25 stone)
- Medicote™ technology for antimicrobial finish assists infection control

Optional Features

- Reflexion® (BB) pressure management seat and Gel (CC) seat options (see page 60)
- Height adjusters
- Removable seat platform for use with dynamic pressure cushion (see page 61)
- Wide range of upholstery finishes (see pages 30-31)
- Range of wood finishes

Arms options:



Drop Arm



Fixed Arm

Wood Finish Options

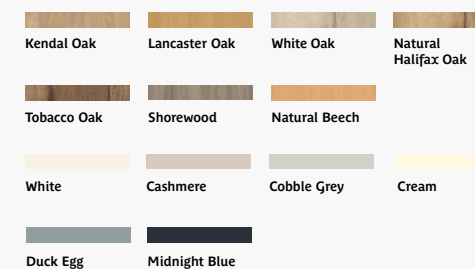

Apollo



PSAP02 Apollo
High Back Chair
with Drop Arms



PSAP03 Apollo
High Back Chair



PSAP04 Apollo
Mid Back Chair

A classic and elegant aesthetic, the Apollo patient seating range has curved arms and deeply padded back and is styled for comfort.

Standard Features

- Stylish curved arm profile
- Ergonomically designed head and lumbar support optimise posture
- Ergonomically positioned arms for easy sit to stand transition
- Sacral gap aids cleaning and infection management
- Resilient to standard infection control cleaning protocols
- Maximum user weight 160kg (25 stone)
- Medicote™ technology for antimicrobial finish assists infection control

Optional Features

- Reflexion® (BB) pressure management seat and Gel (CC) seat options (see page 60)
- Height adjusters
- Removable, depth adjustable seat
- Removable seat platform for use with dynamic pressure cushion (see page 61)
- Wide range of upholstery finishes (see pages 30-31)
- Range of wood finishes

Options

See page 45 for all Features & Accessories

Wood Finish Options

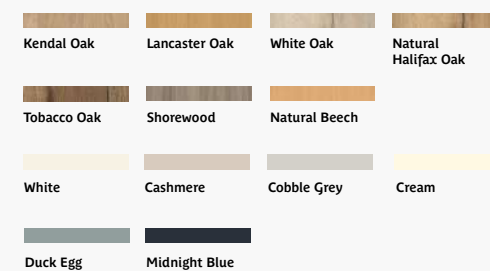

Renaissance



Thoughtfully designed, Renaissance is equally suitable as a bedside chair, or in a more relaxed lounge setting. Available with upholstered or open arms.

Standard Features

- Fixed waterfall seat cushion
- Supportive posture back
- Integral grip arms
- Robust, durable solid beech frame with mortise and tenon construction

Optional Features

- Comfort Seat
- Pressure foam seat
- Customise from a wide range of fabrics (see pages 30-31) and wood finishes to enhance any space



Open arms



Infill arms



Supportive posture back

A beautiful solid beech frame contrasts with supportive back to ensure optimum posture, while easy rise arms aid mobility.



PSRE01 Renaissance
Mid Back Armchair
with Open Arms



PSRE02 Renaissance
High Back Armchair
With Open Arms



PSRE03 Renaissance
Mid Back Armchair
with Arm Infills



PSRE04 Renaissance
High Back Armchair
with Arm Infills

Wood Finish Options



Velvare



Velvare LSVE01 High Back Armchair

With ergonomically designed and supportive back and arms, adjustable lumbar support and pressure care seat options, Velvare is perfect for use in patient spaces, maternity units, waiting rooms and lounge areas.

Standard Features

- Contemporary aesthetic with curved profile
- Ergonomically designed head and lumbar support optimise posture
- Easy rise arms aid sit to stand transition
- Resilient to standard infection control cleaning protocols
- Maximum user weight 160kg (25 stone)
- Medicote™ technology for antimicrobial finish assists infection control

Optional Features

- Reflexion® pressure management seat options
- Orb handgrips assist standing
- Mid-size back rest
- Sewn in seams to prevent concealment
- Wide range of upholstery finishes (see pages 30-31)
- Range of wood finishes



Velvare ergonomic armchair range.



LSVE01 Velvare
High Back Armchair with Orb Handgrips & Headrest



LSVE02 Velvare
Mid Back Armchair with Orb Handgrips



LSVE03 Velvare
High Back Armchair with Headrest, without Handgrips



LSVE05 Velvare Club
High Back Armchair with Headrest



LSVE06 Velvare Club
Mid Back Armchair

Velvare features a profiled back with adjustable lumbar support for positioning and postural management.

Wood Finish Options



Salus



Salus PSSA02 High Back Armchair in Cappuccino with Sloping footstool PSSA03 in Regal Silver

Salus is an innovative, ergonomically designed patient chair, providing continuous postural support with Medipur™ anti-microbial surfaces. Designed by Tim Wallace.

Standard Features

- Integral skin Medipur™ with soft compressible centre and an outer impermeable surface
- Housekeeping wheels as standard
- No stitching and smooth underside assist in infection control
- Contoured seat/back replicate the shape of the body, compressing to offer continuous postural support.
- Pressure relieving seat with sprung internal frame relieves pressure on the sacral area
- Maximum load 160kg (25st)
- Sloping footstool slides under the Salus chair

Options

- Height adjustable legs
- Sloping footstool (Regal Silver frame) Available in a range of contract vinyl options

Innovative, award winning, ergonomically designed patient chair.

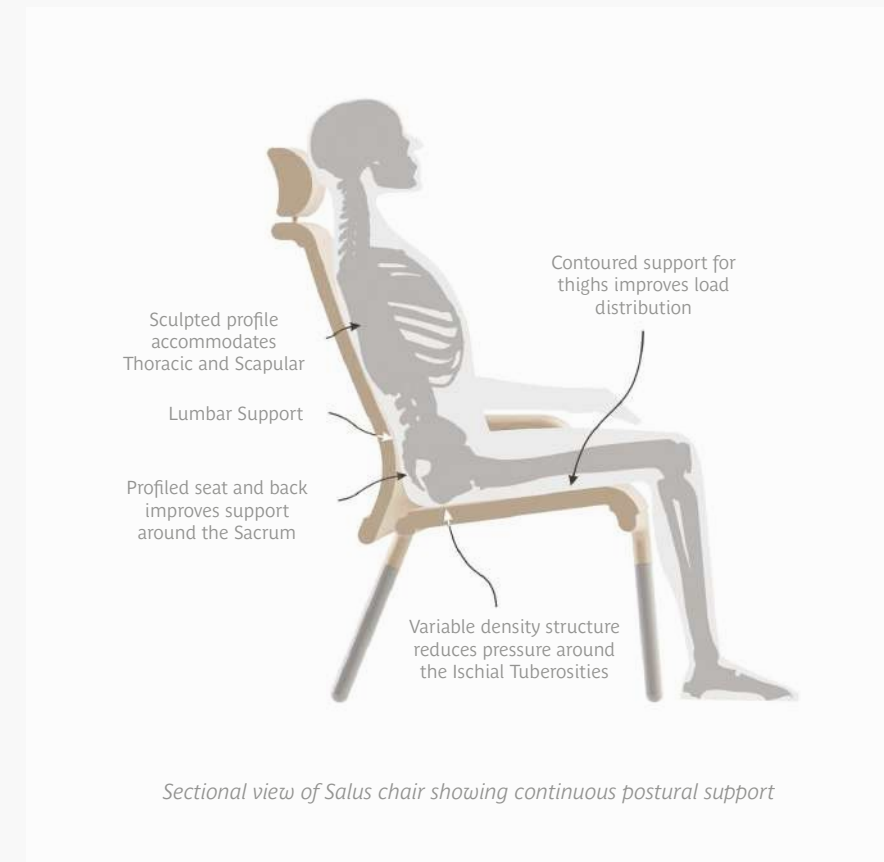

PSSA01 Salus High Back Chair with Headrest



PSSA02 Salus High Back Armchair with Headrest



PSSA03 Salus Sloping Footstool available in a range of contract vinyl options.



Soft compressible seat

Chair Colour Options:

- Navy
- Blue
- Cappuccino

Frame Colour Option:

- Regal Silver



Pressure Care

Pressure Sores - The Issue

A pressure injury is an area of localised damaged skin and underlying tissue caused by pressure (or pressure combined with shear) over prolonged periods.

This pressure restricts blood supply to tissues with resulting shortage of oxygen needed for cellular metabolism to keep tissue alive – “ischemia”.

The most susceptible areas are the skin over any bony prominences such as the sacrum, coccyx, heels or the hips, but other sites such as the spine, shoulders, elbows, knees, ankles, or the back of the cranium are also susceptible.

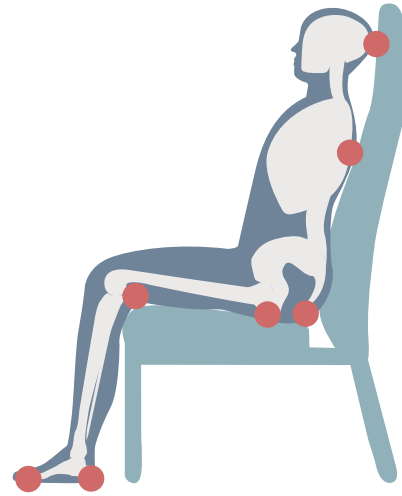

Holistic Assessment & Treatment

Within the clinical assessment and treatment of pressure sores, a holistic approach is needed combining the following areas of consideration:

PERSON CENTRED ASSESSMENT	RISK ASSESSMENT	TREATMENT
<p>Age</p> <p>Medical history and medications</p> <p>Current health – e.g., neurological conditions with lack of sensation, diabetes, lymphoedema, COPD</p> <p>Haematological assessment</p> <p>Nutrition and hydration</p> <p>Body size and proportions</p> <p>Ability to mobilise/change position</p> <p>Degree of independence</p> <p>Continence</p>	<p>Use of validated scales such as:</p> <ul style="list-style-type: none"> Waterlow Braden Norton <p>Environmental conditions</p> <ul style="list-style-type: none"> Size of room Isolation Temperature Humidity <p>Correct seating size and style e.g. bariatric care</p> <p>Number of hours spent lying and seated</p>	<p>Cleaning and Dressing:</p> <ul style="list-style-type: none"> For stage I sores, gently wash with mild soap and water. For stage II sores, clean with a saltwater (saline) rinse to remove loose, dead tissue. <p>Dressings may include hydrocolloid dressings, foam dressings, or other specialized wound coverings.</p> <p>Preventing infection – antibiotics and antibiotic creams</p> <p>Pressure distributing seating (see page 60) and mattresses</p> <p>Regular, routine repositioning every 15 to 30 minutes</p> <p>Pain management</p> <p>General nutrition</p>

Quick Reference Guide

Please choose from the two pressure relieving seat options below:

DESCRIPTION OF REQUIREMENT	SOLUTION
<p>Patients with reduced mobility (due to age, accident or illness) who must sit for lengthy periods but can modify their position and stand unaided if they need to.</p> <p>General bariatric care.</p>	<p>BB</p> <p>Medium/High Risk Reflexion® Visco Foam</p> <p>See page 60 for further details</p>
<p>Patients who have some difficulty repositioning themselves independently. They may slump to one side, forward or slide down the chair needing some help from carers to regain a mid-line posture.</p> <p>Patients who have thin or fragile skin and who are a high pressure risk.</p>	<p>CC</p> <p>High Risk Pressure Foam with Gel Insert to enhance performance of the Reflexion foam</p> <p>NB: whilst heat itself may not directly create pressure sores, it may exacerbate the risk factors that lead to their development: Excessive moisture leads to sweating and increased moisture on the skin. Prolonged exposure to moisture raises the risk of pressure sores.</p> <ul style="list-style-type: none"> Heat renders the skin more sensitive and vulnerable to friction and shear. Heat causes blood vessels to dilate resulting in increased blood flow to the skin. This is generally beneficial for wound healing but can be detrimental to pressure sores. Excessive blood flow may further damage already compromised tissue, delaying the healing process. Heat related discomfort may discourage movement and increase risk of pressure on certain areas <p>*Gel keeps the foam cooler longer but will eventually adapt to the temperature of the foam around it.</p> <p>See page 60 for further details</p>

Pressure Care Seating

Integrated pressure care foams contribute to an active pressure ulcer prevention and management strategy, as well as reducing the risk of falls and are used by numerous NHS Trust's and Health Boards as part of their programme.



1. Reflexion® Visco Seat (BB)

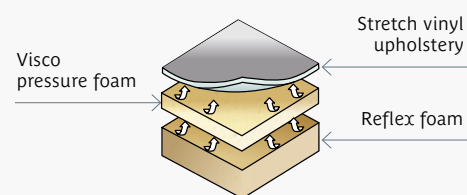

Medium to high risk Reflexion® Visco pressure foam to facilitate blood circulation and distribute weight evenly.

2. Gel Visco Seat (CC)

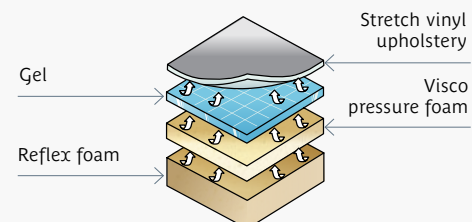

High risk Reflexion® Visco pressure foam with the addition of a gel layer, ideal for those seated most of the time.

Dynamic Pressure Cushion

Removable Seat Platform for use with Dynamic Pressure Cushion

Teal offer an interchangeable seat platform option for use with its patient seating ranges.



Dynamic Pressure Cushion

The removable seat platform allows for the safe use of a Dynamic Pressure Cushion in place of the existing seat (without changing the seat height), avoiding the risk of slips and falls by ensuring the seat remains at the correct height for patient use.

The seat platform can then be stored with the Dynamic Pressure Cushion for future use.



Stretch Vinyl Upholstery Options

Pressure Care foams perform best when upholstered with a stretch vinyl which allows maximum movement of the foam.

Inclusive, patient-centred care requires bariatric seating that enhances comfort and posture, supporting patient's Wellbeing. Mobility issues often mean long periods of sitting.

Our bariatric seating combines comfort and safety with an attractive aesthetic and functional design.



Customise from a wide range of upholstery options.



Multiple vinyl / fabric upholstery options & colours available
see pages 30-31 for further information

See pages 310-311 for
product dimensions

Bariatric+ Seating

Whittle



Designed to maximise comfort and support, Whittle is a highly durable collection of exceptionally engineered bariatric chairs with integral pressure management. Complements the Teal patient seating range.

Standard Features

- Maximum load up to 245kg (40st) 747/747D. All other models maximum load up to 320kg (50st)
- Ergonomically designed posture back for head / lumbar support
- Pressure foam seat (BB) standard - for use with multi-stretch fabric options
- Large housekeeping wheels
- Sacral gap as standard
- Styled to fit in with our patient seating range

Options

- Removable, depth adjustable seat option (2 positions) for infection management
- Wide range of upholstery finishes (see pages 30-31)
- Wood stain options



747 Whittle Bariatric
Wide Heavy Duty Chair with Fixed Arms

254kg (40st) OW:735

747D Whittle Bariatric
Wide Heavy Duty Chair with Drop Arms

254kg (40st) OW:735



747X Whittle Bariatric
Wide, Extra Large Heavy Duty Chair with Drop Arms

320kg (50st) OW:825

747XD Whittle Bariatric
Wide, Extra Large Heavy Duty Chair with Drop Arms

320kg (50st) OW:825



747XX Whittle Bariatric
Extra Wide, Extra Large Heavy Duty Chair with Fixed Arms

320kg (50st) OW:925

747XXD Whittle Bariatric
Extra Wide, Extra Large Heavy Duty Chair with Drop Arms

320kg (50st) OW:925

Three widths and two weight limits provide flexible seating options for bariatric care.

Integral pressure management seat assists the even distribution of weight, minimising the load on pressure points and potential discomfort, helping to reduce the risk of pressure ulcers.

Wood Finish Options



Tolero Bariatric



Tolero Bariatric includes Reflexion® medium to high risk pressure care seat and integral housekeeping wheels for ease of movement as standard. Tolero Bariatric shown above in comparison to standard model.

Maximum user weight 320kg (50st).



PSTL07
Tolero High Back
Bariatric Chair



PSTL08
Tolero High Back
Bariatric Chair, Drop Arms

With its sleek, contemporary profile the Tolero metal patient chair is the perfect solution for bariatric care in patient rooms and waiting areas.

Frame colour options:



Stone



Onyx



Anthracite

Black arms as standard

Teal offer a range of specialist, strengthened seating for bariatric care - including bedside recliners and waiting room chairs.



REAG24 Galaxy Recliner
Electric Rise/Independent Recline.
Trendelenburg Bariatric
220kg (35st)



REAS24 Astra Recliner
Electric Rise/Independent Recline.
Trendelenburg Bariatric
220kg (35st)



REAS25 Astra Recliner
Electric Rise & Recline Bariatric
320kg (50st)

Contemporary or classic designs for bariatric care seating for Reception areas, Consultants Rooms and Waiting Rooms. Specialist Seating is essential for people with limited mobility, often due to long-term illness, accidents, or age-related deterioration.



RCBB01 Orion
Bariatric Beam Seat
320kg (50st)



RCBB02 Orion
Bariatric Beam Seat with Arms
320kg (50st)



RSHA01 Haywood
Bariatric Seat with Arms
220kg (35st)



RSAD2-01 Adeo
Bariatric Chair
220kg (35st)



RSAD2-02 Adeo
Bariatric Chair with Arms
220kg (35st)



LSAT11 Atlas
Bariatric Armchair
with Fixed Seat
220kg (35st)

Visits from loved ones are important to the health and wellbeing of patients receiving care in care homes, hospitals and hospices – an essential part in providing high quality care. Our range of bedside sleepover solutions for family or clinicians is available with standard or compact width options.



Buddy Day Bed BDBU21 shown in dual fabric.

Sleepover+ Solutions



Multiple vinyl / fabric upholstery options & colours available
see pages 30-31 for further information

See page 311 for
product dimensions

Buddy Day Bed



Buddy Day Bed BDBU21 / Day Bed / Attendant Chair

Buddy is designed for relaxation and for family sleepovers in patient rooms. Ideal for maternity, paediatrics and palliative care.

Standard Features

- Stylish contemporary design
- Easy operation
- Extends to 2m bed
- Storage boxes under seat for pillows & blankets, with protective cover
- Space saving
- Fully open head area for clear visibility
- In-line locking front castors. Swivel rear castors for manoeuvrability. Easy push button operation
- Reclines to any angle
- Maximum user weight: 160kg (25st)

Options

- Two width options: standard model and Buddy compact - where room size only permits a small footprint.
- Available in a wide range of fabric and vinyl options (see pages 30-31)



BDBU21 Buddy
Day Bed /
Attendant Chair

OW: 870
SW: 640



BDBU22 Buddy
Compact Day Bed /
Attendant Chair

OW: 730
SW: 500



Buddy features easy push button operation, allowing the back to be lowered or raised. The continuous movement back can be stopped in any position for personalised comfort.



Stylish contemporary design and easy to operate, Buddy extends to a 2-metre bed, with fully open head area and storage compartment with protective cover for pillows, blankets and other accessories.



Moby



Moby Sofa Bed BDM001RH shown with right hand opening

Moby can help make the most of your space. Designed to fit into a patient room and provide a sleepover option when opened, whilst still maintaining a small footprint when closed.

Standard Features

- Stylish contemporary design
- Easy operation
- Extends up to 2m bed
- Storage box under extended side for pillows and blankets, with protective cover
- 65mm Braked Castors

Optional Features

- Available in a wide range of fabric and vinyl options (see pages 30-31)



BDM001LH Moby
Sleepover Sofa Bed
with Left Hand Front Extending Arm

OW: 1600 - 2350
SW: 1300 - 2000



BDM001RH Moby
Sleepover Sofa Bed
with Right Hand Front Extending Arm



Moby Compact: where room size only permits a small footprint.

BDM002LH Moby Compact
Sleepover Sofa Bed with Left Hand Opening

BDM002RH Moby Compact
Sleepover Sofa Bed with Right Hand Opening

OW: 1540 - 2040
SW: 1500 - 2000

To suit the room layout Moby can be handed with the pull-out section on the left or right hand side.

Removing the back cushions and rolling out the extendible base allows Moby to convert easily into an overnight sleep solution.



Moby is designed with space and style in mind and easily converts into a 2-metre bed, with a practical underbed storage box for pillows and blankets.

Maximum user weight: 160kg (25st).



Moby Curve



Moby Curve BDMC01RH shown with right hand folding drop arm

To suit the room layout Moby Curve can be handed with the drop arm section on the left or right hand side.



BDMC01LH Moby Curve
Sofa Bed with Left Hand Folding Drop Arm



BDMC01RH Moby Curve
Sofa Bed with Right Hand Folding Drop Arm

Contemporary, asymmetrical aesthetic, the Moby Curve sleep solution is designed to fit into patient rooms and provide a sleepover option when opened, maintaining a small footprint

- Standard Features**
- Sofa to Bed; dropping the arm allows the sofa to turn into an extended bed - from 1850mm width to 2050mm width
 - Folding Arm: Arm works on a ratchet mechanism - push to drop, raises in notches
 - Hinged, lifting seat, opens up the storage space under the seat
 - 65mm Braked Castors
 - Wooden Bed Slats

- Optional Features**
- Available in a wide range of fabric and vinyl options (see pages 30-31)



Mandy Sofa Bed



Mandy sofa bed range offers maximum flexibility and is available as a single, double or 3-seater option for staff, visitor and doctor's rooms. Ideal in maternity, paediatric and palliative care areas.

Standard Features

- Contemporary and compact
- Integral sofa bed mechanism
- Extended length 2.2 metres
- Removable Seat
- Fabric mattress (100mm depth)

Optional Features

- Loose cushions
- Waterproof mattress (100mm depth)
- Available in a wide range of fabric and vinyl options (see pages 30-31)
- Wood finish options



A stylish and compact sleepover solution, part of the Mandy soft seating range of sofas and armchairs.



SSMA24 Mandy
Single Sofa Bed
with Fabric Non-Waterproof
Mattress



SSMA25 Mandy
2 Seater Sofa Bed
with Fabric Non-Waterproof
Mattress



SSMA26 Mandy
3 Seater Sofa Bed
with Fabric Non-Waterproof
Mattress

Mattress Sizes

SSMA24 Mattress
Width 730mm
Length 1830mm
Overall depth 100mm
Crib 5 Sprung interior mattress

SSMA25 Mattress
Width 1130mm
Length 1830mm
Overall depth 100mm
Crib 5 Sprung interior mattress

SSMA26 Mattress
Width 1330mm
Length 1830mm
Overall depth 100mm
Crib 5 Sprung interior mattress

Mattress is supplied as standard for all models. Waterproof mattress upgrade options available.

Wood Finish Options

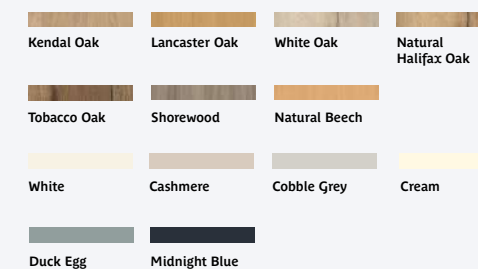

Healthcare environments can appear structured and unfamiliar to children, who in addition to feeling unwell, are away from home.

The Teal paediatric range offers soft surfaces, organic shapes and fun, friendly colours to help make children feel at home for the duration of their stay.



Paediatric+ Solutions



Multiple vinyl / fabric upholstery options & colours available
see pages 30-31 for further information

Flex soft foam seating provides a safe and stable space for children's play.



Standard Features

- Lightweight and safe soft block foam construction
- Fire retardant CMHR foam
- Modular design allows multiple configurations
- Easily arranged to suit any area

Optional Features

- Zip or Fully Sewn Finish (except FSFX12, FSFX13, FSFX14 zipped finish. SSEL01 / 2, only available with fully sewn finish)



FSFX01 Flex
600sq Cube
W: 600 D: 600 H: 450



FSFX02 Flex
600rd Cylinder
W: 600 D: 600 H: 450



FSFX03 Flex
Hexagon
W: 625 D: 555 H: 450



FSFX04 Flex
Wide Hexagon
W: 865 D: 555 H: 450



FSFX05 Flex
Large Hexagon
W: 1260 D: 555 H: 450



FSFX06 Flex
Modular Unit Chair
W: 550 D: 810 H: 835
SH: 480



FSFX08 Flex
3 Seater Sofa
W: 1650 D: 975 H: 835
SH: 480



FSFX09 Flex
Lounger
W: 600 D: 920 H: 925
SH: 410



FSFX10 Flex
Rocking Lounger
W: 600 D: 920 H: 925
SH: 475



FSFX11 Flex
Lounger Footstool
W: 600 D: 790 H: 475



FSFX12 Flex
2 Seater Bench
W: 1375 D: 620 H: 470



FSFX13 Flex
2 Seater Bench with Scallop
W: 1310 D: 620 H: 470

Back to contents

Customise from a wide range of fun, calming & friendly colours to create a welcoming, inviting environment.



FSFX14 Flex
3 Seater Bench
W: 2130 D: 620 H: 470



FSFX15 Flex
Lightweight Soft Beanbag
W: 900 D: 900 H: 600



FSFX16 Flex
Lightweight Soft Beanbag with Back Rest
W: 900 D: 900 H: 800



FSFX17 Flex
600rd Cylinder with Scallop
W: 600 D: 530 H: 450



FSFX18 Flex
450rd Cylinder
W: 450 D: 450 H: 450



FSFX19 Flex
450sq Cube
W: 450 D: 450 H: 450



SSEL01 Elle
Extra Large Scatter Cushion
W: 1000 D: 1000 H: 310



SSEL02 Elle
Extra Large Folding Scatter Cushion
W: 1000 D: 2000 H: 310

Breeze children's stacking chairs are designed to promote good posture and provide exceptional comfort.



DCBR01 Breeze
Children's Stacking Chair

OH: 500 OD: 330
OW: 350 SD: 250
SW: 280 SH: 260

Standard Features

- Stacks 12 high
- Durable, stain resistant and 100% recyclable
- Safe, stable design
- 6 size options available

Other seat height options available:

DCBR02 SH: 310
DCBR03 SH: 350
DCBR04 SH: 380
DCBR05 SH: 430
DCBR06 SH: 460

Finishes

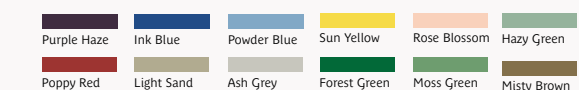

Blending innovation with on-point functionality, Teal bedside ranges bring an attractive aesthetic to wards and patient bedrooms with a focus on infection control and manual handling.



Perry 730 High Back Patient Chair shown with Infiniti OBIN01 Overbed Table

Ward+ Furniture



Multiple vinyl / fabric upholstery options & colours available
see pages 30-31 for further information

See pages 312-313 for
product dimensions

Infniti



Infniti OBIN01 Fixed Top Overbed Table with Grey Base & White Top

With elegant, seamless design, Infniti is used around seating and over-bed. The moulded contoured top prevents spills and smooth surfaces facilitate easy cleaning. The robust, high quality cast horse-shoe base with anti-bacterial finish has a sealed underside to enhance infection control.

Standard Features

- Overbed table with fixed or tilt top options, contoured to stop liquid spills
- Smooth surfaces for infection control
- Smooth gas assisted rise and fall column with anti-entrapment feature
- Horseshoe base - allows usage around a chair or over a bed
- High quality cast base with anti-bacterial finish and fully sealed underside for infection control
- Non marking twin wheel castors allow easy repositioning

Options

- Locking castors
- White or grey column and base
- Top colour options



Smooth action height adjustable overbed table with anti-entrapment feature, high quality cast base with anti-bacterial finish and smooth, sealed underside. KYDEX® and tilt top options available.



OBIN01 Infniti
Overbed Table
Moulded One-Piece Fixed Top



OBIN02 Infniti
Overbed Table
White or Grey
KYDEX® Top Option



OBIN02 Infniti
Overbed Table
Natural Beech
Vinyl Wrapped Top Option



OBIN03 Infniti
Overbed Table with Tilt Top
White or Grey
KYDEX® Top Option



OBIN03 Infniti
Overbed Table with Tilt Top
Natural Beech
Vinyl Wrapped Top Option

What is KYDEX®?

KYDEX® is a sustainable, thermoplastic blend of PVC and acrylic that renders surfaces tough, resilient and heat resistant. Smooth surface aids cleaning and infection control. Available on bedside tables, bedside cabinets and many selected hard surfaces.

Top Colour options:

- White KYDEX®
- Grey KYDEX®
- Natural Beech
- Vinyl Wrapped

Moulded Top Colour options:

- White
- Grey

Column & Base Colour options:

- White
- Grey



Affiniti



Patient access to storage for valuables and drugs is increasingly important to NHS Trusts who have a responsibility for their safe keeping.

Mobiles, tablets, jewellery etc need lockable facilities and secure compartments are required for patients' home drugs in addition to those prescribed by the hospital. Affiniti provides up to 3 lockable compartments (either digital or barrel lock) to accommodate valuables, patients' home drugs and hospital prescription drugs.



BLAF51 Affiniti
Twin Top Drawers with Key Locks, Middle Drawer



BLAF52 Affiniti
Twin Top Drawers with Key Locks, Middle Drawer & Lower Drawer



BLAF53 Affiniti
Large Top Drawer with Key Lock, Middle Drawer



BLAF54 Affiniti
Large Top Drawer With Key Lock, Middle Drawer, Lower Drawer

Affiniti is an innovative, award winning, one piece moulded bedside locker for the modern care facility with unique infection control features. No corners, no edges, just an easy clean non-porous surface resilient to NHS cleaning protocols.

Standard Features

- Twin top drawers or full width medicine drawer which features stepped levels inside drawer for 500ml bottle
- Moulded wipe clean anti-bacterial polyethylene surfaces help reduce HCAI's
- Able to withstand Hypochlorite solution and tolerate Hydrogen Peroxide Vapourisation
- Easily movable with modern 100mm castors
- Four braked castors
- Space for patient belongings
- Easy grip drawer handles
- Not handed - can be used either side of a bed
- Liquid containment top

Options

- Patient valuables drawer, LHF or RHF (per Drawer)
- Electronic Digi lock; to upper right drawer on BLAF51 & BLAF52
- Electronic Digi lock; to upper drawer on BLAF53 & BLAF54
- Electronic RFID lock; to upper right drawer on BLAF51 & BLAF52
- Electronic RFID lock; to upper drawer on BLAF53 & BLAF54
- RFID lock additional access card
- RFID lock additional fob
- Locker suiting



Electronic Digi Lock option



Electronic RFID Lock option



Affiniti
Patient Valuables Drawer option



Drawer colour options:

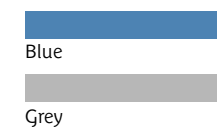

*Full width medicine drawer



Cascade



[Back to contents](#)



BLCC21 Cascade
Large Top Drawer with Key Lock, 2 Lower Doors, MFC Top

KYDEX® Top option



BLCC22 Cascade
Twin Top Drawers with Key Locks, 2 Lower Doors, MFC Top

KYDEX® Top option



BLCC23 Cascade
Large Top Drawer with Key Lock, 2 Lower Doors, Combined Wardrobe MFC Top

KYDEX® Top option

Right hand robe shown also available left hand.



BLCC24 Cascade
Twin Top Drawers with Key Locks, 2 Lower Doors, Combined Wardrobe MFC Top

KYDEX® Top option

Right hand robe shown also available left hand.

Cascade patient bedside lockers have formed the benchmark for hospital and healthcare environments. Available in a range of sizes, colours and configurations.

Standard Features

- White 25mm MFC top, stain resistant, bleach cleanable
- Easy clean laminate with co-ordinating edges
- Strong, quality construction
- Quality 65mm locking front castors
- Colour options for dementia friendly use
- Key lock (standard)

Options

- KYDEX® top option
- KYDEX® top colour options
- Lock options - electronic digi lock or electronic RFID lock to upper drawer
- RFID lock additional access card
- RFID lock additional fob
- Locker suiting

What is KYDEX®?

KYDEX® is a sustainable, thermoplastic blend of PVC and acrylic that renders surfaces tough, resilient and heat resistant. Smooth surface aids cleaning and infection control. Available on bedside tables, bedside cabinets and many selected hard surfaces.

Drawers & Door colour options:

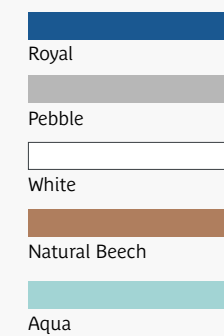

Top Colour options:

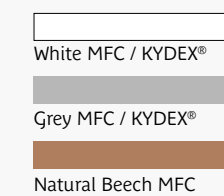

MFC Top with Key lock (Standard)



KYDEX® Top with Electronic RFID Lock (Option)



Electronic Digi Lock (Option)



Braked Castors



Body White as standard (Royal, Pebble, White, Aqua drawers & doors).
Natural Beech body with matching Beech drawers and doors.

Cascade Pro / Cascade Plus



Cascade Pro BLCC41 (left) shown with upper drawer key lock (standard). Cascade Plus BLCC31 (right) shown with upper drawer digi lock option and middle drawer key lock option.

Cascade Pro/Plus are extra-large bedside lockers developed specifically for patients, providing easy, safe and secure care of patient valuables and medications.

Standard Features

- Extra-large bedside lockers developed specifically for patients - providing easy, safe and secure care of patient valuables and medications
- Cascade Pro has a deeper middle drawer and greater overall height than the Cascade Plus
- Large upper drawer (with key lock as standard), middle drawer, two lower doors with handles
- KYDEX® top, stain resistant, bleach cleanable
- Easy clean laminate with 2mm PVC edges
- Strong, quality construction
- Quality 65mm locking front castors
- Soft bow handles on all drawers and doors

Options

- KYDEX® top colour options
- Key lock to middle drawer
- Lock options - electronic digi lock or Electronic RFID lock to Upper or Middle Drawer
- RFID lock additional access card
- RFID lock additional fob
- Locker suiting

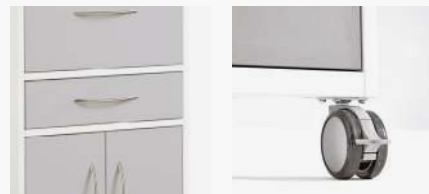

Large top drawer (with key lock), middle drawer and 2 lower doors with handles. Quality 65mm locking front castors.



BLCC31 Cascade Plus
Large Bedside Locker,
Large Top Drawer with Key Lock,
Middle Drawer, Lower Doors with
KYDEX® Top

W: 505
H: 1050







BLCC41 Cascade Pro
Extra Large Bedside Locker,
Large Top Drawer with Key Lock,
Middle Drawer, Lower Doors with
KYDEX® Top

W: 555
H: 1140



What is KYDEX®?

KYDEX® is a sustainable, thermoplastic blend of PVC and acrylic that renders surfaces tough, resilient and heat resistant. Smooth surface aids cleaning and infection control. Available on bedside tables, bedside cabinets and many selected hard surfaces.

Drawers & Door colour options:

-  Royal
-  Pebble
-  White
-  Natural Beech
-  Aqua

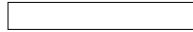
Top Colour options:

-  White MFC / KYDEX®
-  Grey MFC / KYDEX®
-  Natural Beech MFC

Body White as standard (Royal, Pebble, White, Aqua drawers & doors).
Natural Beech body with matching Beech drawers and doors.



Glide Stools



With a hand operated rise mechanism and upholstered or PU seats Glide is available with round stool, ergonomic saddle and draughtsman options. Castor options are available to suit user preference and for carpeted or hard floor surfaces.

Glide is a multi-purpose gas lift stool collection which combines freedom of movement with multiple configuration options, helping to create the optimum seating position for healthcare professionals in a variety of settings.



MSGL01 Glide
Round Stool
Upholstered Seat

MSGL02 Glide
Round Stool
PU Seat

MSGL03 Glide
Round Draughtsman Stool
Upholstered Seat

MSGL04 Glide
Round Draughtsman Stool
PU Seat



MSGL05 Glide
Saddle Stool
Upholstered Seat

MSGL06 Glide
Saddle Stool
PU Seat

MSGL07 Glide
Saddle Draughtsman Stool
Upholstered Seat

MSGL08 Glide
Saddle Draughtsman Stool
PU Seat

Standard Features

- Comprehensive model options provide comfort and support during prolonged periods of seated work
- Simple to operate height adjustment - via ring mechanism mounted on underside of seat
- Seat options: Upholstered seat or durable PU. Upholstered seat features moulded foam for added comfort and is available in a wide range of upholstery options and colours (see pages 30-31)
- Durable 5-star base (black only)
- Choice of castors
- Maximum user weight: 110kg (18st)

Optional Features

- **Castors;**
Hard or soft wheel castor options available.
Hard wheel castors are suitable for carpeted areas, soft wheel castors for hard floor surfaces.
- **Choose from the following options:**
 - Standard castors with no brakes
 - Brake loaded castors - castors brake under the additional weight of a user. Without a user castors are free moving
 - Brake unloaded castors - castors are braked without a user. When a user sits on the stool brakes are released, castors are free moving

Finish options

- Upholstered seat models: Available in a wide range of upholstery options and colours (see pages 30-31)
- PU seat black only
- Draughtsman stool - chrome ring only



Models with back shown on next page

Glide Operator Chairs



Uncompromising strength and durability are the key drivers of Glides design.

With a hand operated rise mechanism and upholstered or PU seats Glide is available with round stool, ergonomic saddle and draughtsman options, with or without a back. Castor options are available to suit user preference and for carpeted or hard floor surfaces.



MSGL09 Glide
Round Stool
Upholstered Seat
Upholstered Back

MSGL10 Glide
Round Stool
PU Seat
Upholstered Back

MSGL11 Glide
Round Draughtsman Stool
Upholstered Seat
Upholstered Back

MSGL12 Glide
Round Draughtsman Stool
PU Seat
Upholstered Back



MSGL13 Glide
Saddle Stool
Upholstered Seat
Upholstered Back

MSGL14 Glide
Saddle Stool
PU Seat
Upholstered Back

MSGL15 Glide
Saddle Draughtsman Stool
Upholstered Seat
Upholstered Back

MSGL16 Glide
Saddle Draughtsman Stool
PU Seat
Upholstered Back

Standard Features

- Comprehensive model options provide comfort and support during prolonged periods of seated work
- Models with back feature 3-way adjustment with back tilt mechanism, separate back height adjustment and gas lift seat height adjustment for optimum comfort
- Seat options: Upholstered seat or durable PU. Upholstered seat features moulded foam for added comfort and is available in a wide range of upholstery options and colours (see pages 30-31)
- Durable 5-star base (black only)
- Choice of castors
- Maximum user weight: 110kg (18st)

Optional Features

- **Castors;**
Hard or soft wheel castor options available. Hard wheel castors are suitable for carpeted areas, soft wheel castors for hard floor surfaces.
- **Choose from the following options:**
 - Standard castors with no brakes
 - Brake loaded castors - castors brake under the additional weight of a user. Without a user castors are free moving
 - Brake unloaded castors - castors are braked without a user. When a user sits on the stool brakes are released, castors are free moving



KwickScreen®

Award-winning wipeable dignity screen enables the flexible transformation and division of open plan areas.

Standard Features

- Patented C-Tube technology
- 360° swivel wheels
- Powder coated aluminium body
- Medical grade castors
- Fully encloses for easy storage
- Wipeable and compliant with infection control protocols
- Quickly retracts for emergency access

Flexible



Our hospital screen instantly creates a hygienic patient space, allowing you to respond to changing demands.

Hygienic



Unlike other medical screens, minimal dirt traps and easy-to-clean, wipeable panels, compatible with all standard cleaning products.

Customisable



All our hospital privacy screens can be printed on both sides, offering endless possibilities for custom artwork.

Sustainable



All KwickScreens® provide a more sustainable alternative to disposable and fabric hospital curtains.

KwickScreen® Pro

Flexible and portable hospital screen.

WFKW25 KwickScreen Pro
Mobile Unit with Clear Screen; 3m Screen Extension

WFKW26 KwickScreen Pro
Mobile Unit with White Screen; 3m Screen Extension

WFKW27 KwickScreen Pro
Mobile Unit with Printed Clear Screen; 3m Screen Extension

WFKW28 KwickScreen Pro
Mobile Unit with White screens printed in a block colour, with text of choice or pictures or illustrations of choice; 3m Screen Extension



All units are 1.9m tall.

The Pro, Air and Duo also come in a shorter 1.6m version if required. Both the Pro and Air extend up to 3m, the Duo can extend up to 6m.

All of the products sit comfortably extended at any length up to these maximums.

KwickScreen® Air

The world's most flexible wall-fixed 3m length screen.

Scientifically proven to improve hygiene when tested against curtains.

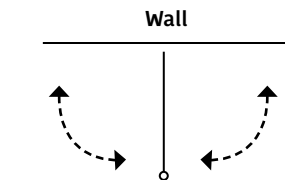

WFKW21 KwickScreen Air
Wall Mounted Unit with Clear Screen; 3m Screen Extension

WFKW22 KwickScreen Air
Wall Mounted Unit with White Screen; 3m Screen Extension

WFKW23 KwickScreen Air
Wall Mounted Unit with Printed Clear Screen; 3m Screen Extension

WFKW24 KwickScreen Air
Wall Mounted Unit with White screens printed in a block colour, with text of choice or pictures or illustrations of choice; 3m Screen Extension

KwickScreen® Duo

Flexible mobile dual retractable screens.

Full extension of up to 6m.

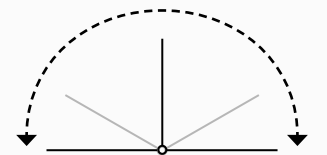

WFKW29 KwickScreen Duo
Mobile Unit with Clear Screens; 2 x 3m Screen Extension

WFKW30 KwickScreen Duo
Mobile Unit with White Screens; 2 x 3m Screen Extension

WFKW31 KwickScreen Duo
Mobile Unit with Printed Clear Screens; 2 x 3m Screen Extension

WFKW32 KwickScreen Duo
Mobile Unit with White screens printed in a block colour, with text of choice or pictures or illustrations of choice; 2 x 3m Screen Extension



The recliner is the optimal seating option for patients and residents in healthcare environments. Teal's wide range of recliner and riser/recliner models incorporate features and options which maximise the benefits to the user.



Durable and resistant to abrasion, a range of stain resistant, waterproof and anti-microbial contract fabrics are available, including vinyl / faux leather and fabric upholstery options.



Multiple vinyl / fabric upholstery options & colours available
see pages 30-31 for further information

See page 313 for
product dimensions

Patient+ Recliners

Choosing Your Recliner

There are factors to consider when choosing the best recliner for purpose. We offer numerous features and options to optimise the benefits of your new recliner.

Questions to consider:

- Location and access to power.
- Location and available space.
- The room itself? Most riser / recliners need to be positioned a metre away from the wall to function properly and protect the chair back.
- Your user's core strength (to determine whether manual or electric).
- Some manual recliners require some strength and may not be suitable for people with limited mobility or balance issues.
- Do you need a recliner or rise and recliner.
- Tilt in space or independent foot and back action.
- Requirement for Trendelenburg facility (the need to elevate feet higher than the head).
- Bariatric care required.
- Removable arm(s) for easy patient transfer.
- Requirement for healthcare specific upholstery.
- Seating periods? Is pressure distributing foam required.
- Accessories required such as fitted table, USB port, lithium ion battery pack.
- Emergency quick release to aid CPR.
- Seat back style: slim back or fibre back.

When all this has been considered, the aesthetic is important and Teal have a wide selection of finishes.



Use this simple aid to help choose your recliner.

Reading down choose:

1. Maximum Weight
2. Mechanism
3. Recliner Style
4. Go to page shown for further details

Max 130kg (20st)				Max 150kg (23st)		Max 160kg (25st)		Max 220kg (35st Bariatric)		Max 320kg (50st Bariatric)
Manual Recliner	Electric Recliner	Electric Recliner *with Emergency Backdrop (EBD)	Electric Rise & Recliner	Manual Recliner	Manual Recliner	Electric Recliner	Electric Rise & Recliner *with Emergency Backdrop (EBD) **Trendelenburg	Manual Hybrid Bariatric / Portering	Electric Rise & Independent Trendelenburg Recliner Bariatric	Electric Rise & Recliner Bariatric

Astra



The Astra recliner range offers a choice of action, with fluid tilt-in-space movement providing a comfortable recline position. Postural support and pressure care management options ensure Astra meets the needs of users in a general ward, day patient and care home settings.

Standard Features

- Tilt-in-space functionality as standard - backrest and seat recline synchronously, helping to maintain posture (except Astra 23T, 24, 25)
- Four heavy duty 65mm lockable castors (except REAS25 - 100mm castors)
- Postural support with pressure management seat options
- One piece arm border - minimises number of seams for infection control

Optional Features

- Reflexion® BB Pressure relief foam
- Anti-pinch seat cover
- Rechargeable battery pack - (Electric models only, except REAS25)
- Comprehensive Servicing and Maintenance options



REAS21 Astra
Manual Recliner, Tilt In Space, Four Heavy Duty 65mm Locking Castors



REAS21E Astra
Electric Recliner, Tilt In Space, Four Heavy Duty 65mm Locking Castors



REAS22 Astra
Electric Recliner Rise & Recline, Tilt-In-Space, Four Heavy Duty 65mm Locking Castors



REAS23 Astra
Electric Recliner, Dual Motor Rise & Recline, Tilt-In-Space, Four Heavy Duty 65mm Locking Castors

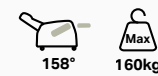

REAS24 Astra
Bariatric Electric Recliner, Dual Motor Electric Rise & Independent Recline, Four Heavy Duty 65mm Locking Castors, Trendelenburg



REAS25 Astra
Bariatric Electric Recliner, Dual Motor Rise & Recline, Four Heavy Duty 100mm Locking Castors



REAS23T Astra
Electric Recliner, Dual Motor Rise & Recline, Four Heavy Duty 65mm Locking Castors, Trendelenburg

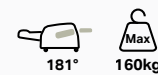

Lockable castors



Adjustable footrest



Easy to use hand controller



Postural support back

Astra Club



Astra Club REAS31E Electric recliner single motor tilt-in-space

**Ideal for use in small private rooms.
Suitable for day patient and care home use.**



REAS31 Astra Club
Manual Recliner, Tilt-In-Space



130° 130kg



REAS31E Astra Club
Electric Recliner, Tilt-In-Space



128° 130kg

An aesthetically designed contemporary recliner range with ergonomic winged back styling, designed with a smaller footprint for bedside use.

Standard Features

- Designed with smaller footprint for everyday use
- Tilt-in-space functionality standard (backrest and seat recline synchronously, helping to maintain posture)
- Advanced mechanisms add to comfort and functionality
- Postural support with pressure management seat options

- One piece arm border minimises number of seams for infection control
- Four heavy duty 65mm lockable castors

Optional Features

- Reflexion™ BB pressure management seat options
- Rechargeable battery pack - (Electric models only)
- Comprehensive Servicing and Maintenance options



Astra Club shown with Host HLT2 table - see page 272 for further details

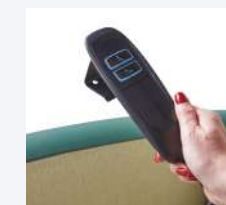

Easy to use hand controller



Adjustable footrest



Compact design



Winged back styling

Astra Lunar



Lunar is a specialist Electric Reclining Patient Chair for multiple healthcare settings including ICU, Neurology, Oncology, Maternity and Patient bedrooms.

Standard Features

- Dual motor controls allow independent control of the back and leg rest for personalised comfort
- Emergency quick release back drop for CPR (allows lowering to 160°). Models **RELU05, 6, 7, 8** only
- Central locking brake system (2 rear wheels) front manual braked castors
- 100mm large castors (non-marking polyurethane tread) for easy manoeuvring - chair can be easily rotated 360° in-situ
- Push bar to assist with manoeuvring (without patient) and for emergency back drop
- Easy operation hand controller & holder strap
- Fold down hook for hanging accessories
- Reflexion® Visco medium to high risk (BB) pressure care foam seat and back

Optional Features

- Fixed or removable arms
- Loose or fixed seat
- Pressure cushion foam options
- Folding side table; left hand or right hand (per arm); fixed arms only
- Anti-pinch seat cover
- Rechargeable battery pack
- Twin port USB charger
- Removable headrest option
- Comprehensive Servicing and Maintenance options



[Back to contents](#)

Patient + Recliners / Astra Lunar



RELU01 Astra Lunar
Electric Recliner, Dual Motor, Tilt-in-Space, Fixed Arms



RELU02 Astra Lunar
Electric Recliner, Dual Motor, Tilt-in-Space, LHF Fixed Arm, RHF Removable Arm



RELU03 Astra Lunar
Electric Recliner, Dual Motor, Tilt-in-Space, LHF Removable Arm, RHF Fixed Arm



RELU04 Astra Lunar
Electric Recliner, Dual Motor, Tilt-in-Space, Removable Arms



RELU05 Astra Lunar
Electric Recliner, Dual Motor, Tilt-in-Space, Emergency Back Drop, Fixed Arms



RELU06 Astra Lunar
Electric Recliner, Dual Motor, Tilt-in-Space, Emergency Back Drop, LHF Fixed Arm, RHF Removable Arm



RELU07 Astra Lunar
Electric Recliner, Dual Motor, Tilt-in-Space, Emergency Back Drop, LHF Removable Arm, RHF Fixed Arm

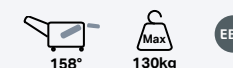

RELU08 Astra Lunar
Electric Recliner, Dual Motor, Tilt-in-Space, Emergency Back Drop, Removable Arms



EBD Emergency quick release back drop

With a high specification as standard Lunar can be customised from a suite of options.

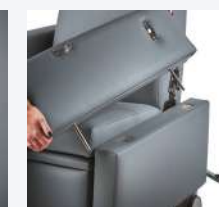
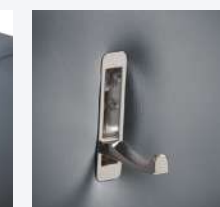

Central locking

Emergency back drop

Fold down hook

Removable arm

Astra Galaxy



REAG23T (left) with removable straight arm option and tilted Reflexion® pressure back option. REAG21 (right) manual recliner with removable wide arm option.

Astra Galaxy is a highly configurable recliner collection with modular arm, back and seat options, offering exceptional levels of support and comfort. Suitable for renal, oncology, day patient and general ward use.

Standard Features

- Manual and electric recliners with tilt in-space functionality (backrest and seat recline synchronously, helping to maintain posture)
- Straight fixed arms

Optional Features

- Slimline foam back (excluding REAG24)
- Tiled reflexion® pressure back
- Tiled fibre comfort back with wings (excluding REAG24)
- Standard removable arm, left hand, right hand or both
- Wide arms (Pair)
- Wide removable arm, left hand, right hand or both
- Folding side table, left hand or right hand
- Reflexion® BB pressure management seat
- Anti-pinch seat cover
- Rechargeable battery pack - (Electric models only)
- Comprehensive Servicing and Maintenance options

See opposite page for arm and back options



REAG21 Astra Galaxy
Manual Recliner, Tilt-In-Space,
Four Large 100mm Locking Castors



REAG21E Astra Galaxy
Electric Recliner, Tilt-In-Space,
Four Large 100mm Locking Castors



REAG22 Astra Galaxy
Electric Rise And Recline, Tilt-In-Space,
Four Heavy Duty 65mm Locking Castors



REAG23 Astra Galaxy
Electric Dual Motor Rise And Recline,
Tilt-In-Space, Four Heavy Duty 65mm
Locking Castors



REAG23T Astra Galaxy
Electric Dual Motor Rise And Recline,
Tilt-In-Space, Trendelenburg,
Four Heavy Duty 65mm Locking Castors



REAG24 Astra Galaxy Bariatric
Bariatric Dual Motor Electric Rise /
Independent Recline, Trendelenburg with
Tiled Pressure Back, Four Heavy Duty
65mm Locking Castors
(Shown with Anti-Pinch Seat Option)



Arm Options

1. Fixed straight arms (standard)
2. Removable straight arms
3. Wide arms
4. Removable wide arms



1. 2. 3.



3. 4. 5.

Back Options

1. Slimline foam back (Standard, excluding REAG24)
2. Tiled Reflexion® pressure back (standard on Bariatric model)
3. Tiled fibre comfort back with wings (excluding REAG24)



1. 2.

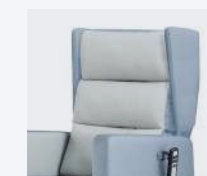

3.

Nevis



Nevis is a manual recliner designed for use in hospital and healthcare environments, maintaining the perfect balance between modern aesthetic and ease of operation, with no compromise on comfort.

Standard Features

- Simple footrest operation using large lever, back operated by the finger pull located on the outside arm, for both carer and patient operation
- Portering handle allows for ease of patient transfer
- Central locking brake system (2 rear wheels) front manual braked castors
- Independent back and footrest movement for personalised comfort
- Soft, adjustable polyurethane headrest (5 x 25mm increments)

- Postural support back with sprung seat for added comfort
- 4 x 100mm heavy duty castors for manoeuvrability (lockable), with 120mm clearance for hoist access
- Easy clean polyurethane arms and headrest for infection control
- Maximum load 220kg (35st/500lbs)

Optional Features

- Anti-pinch seat cover
- Pull out foot tray
- Comprehensive Servicing and Maintenance options



A hybrid recliner, Nevis can accommodate bariatric patients up to 220kg (35st/500lbs) and can also be used as a portering chair for patient transfer.



RENE01 Nevis
Manual Recliner
PU Arms & Headrest
(Shown with anti-pinch seat cover option)



RENE02 Nevis
Manual Recliner
Upholstered Arms & PU Headrest
(Shown with standard seat)

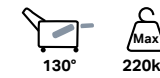

Portering handle

Back release

Central locking rear wheels

Polyurethane headrest

Avia



The backrest has been thoughtfully designed to follow the natural curvature of the spine, providing full ergonomic support. This design promotes healthy posture for both patients and caregivers, providing deep rest and relieving muscle tension.



MRAV01 Avia
Manual Recliner,
Two Rear 100mm Castors
with Individual Brakes, Rear Handle,
Side Accessory Holder

Extended Length 1470mm



MRAV02 Avia
Manual Portering Recliner,
Four 100mm Castors,
Central Locking Brake System (two rear
wheels), Retractable Footrest, Rear Handle,
Side Accessory Holder



With a blend of comfort and reliability Avia's advanced ergonomics are perfectly tailored to the needs of patients and caregivers. The zero-gravity position promotes even distribution of body weight, enhancing blood circulation, relieving back and limb pressure.

Standard Features

- Telescopic armrest for safe side transfer (access from either side)
- Multi-position backrest - can be automatically locked in any position
- Independent leg rest adjustment promotes blood circulation and muscle relaxation. Legrest operated by side lever, independent of the backrest
- Non-slip retractable footrest (**MRAV02** only)
- Adjustable neck cushion for extra comfort
- Rear manoeuvring handle
- Side accessory holder
- Removable seat for infection control
- Epoxy coated metal components for durability
- Maximum load 150kg (23st)
- Reflexion® BB pressure management seat

Optional Features

- IV Pole with 2 hooks
- Headrest
- Comprehensive Servicing and Maintenance options



Multi-position backrest



BB pressure management seat



Removable seat

Astra Stellar



Astra Stellar REST22 shown with standard back and arms

Astra Stellar has a high specification as standard including emergency back release and can be customised from a suite of options.



REST21 Astra Stellar
Electric Recliner, Dual Motor, Tilt-In-Space, Standard Back, Emergency Backdrop (Shown with standard back)



REST22 Astra Stellar
Electric Recliner, Dual Motor Rise & Recline, Tilt-In-Space, Standard Back, Emergency Backdrop (Shown with Waterfall back & USB options)



The Astra Stellar specialist electric recliner is designed with enhanced patient features, for treatment areas including Oncology, Renal and Recovery Suites.

Standard Features

- Postural support with Reflexion® pressure relief BB seat, arm tops and leg support as standard
- Tilt-in-space functionality as standard
- Extra wide 150mm arms for added comfort during procedures
- Emergency quick release back (165°)
- Dual motor allows independent back and footrest operation
- Manoeuvring handle for ease of movement (not for portering)
- Heavy duty 65mm lockable castors

Optional Features

- Standard removable arm, left hand, right hand or both
- Waterfall back
- Anti-pinch seat cover
- Rechargeable battery pack
- USB connectivity for phone / tablet
- Folding table LHF or RHF (anti-microbial polymer)
- Comprehensive Servicing and Maintenance options



Astra Stellar shown with Host HLT2 table - see page 272 for further details

 Emergency quick release back drop

Handset operated tilt-in-space electric recline with dual motor, allowing independent back and footrest operation.



Folding table option



USB option



Footrest as standard



Removable arm option



Wynne



Aesthetically designed reclining chair designed to complement the Teal patient seating range.

Standard Features

- Manual or electric recline
- Aesthetically designed curved arm top
- Ergonomically designed with high back for head/lumbar support
- Medicote™ anti-bacterial finish technology for infection management
- Easy to use hand controller (Electric models)

Optional Features

- Large braked castors
- Upholstered armpads
- Reflexion® Visco medium to high risk pressure care foam seat
- Wood finish options
- Comprehensive Servicing and Maintenance options



Wynne is a comfortable, compact patient / visitor recliner chair, ideal for small spaces.



760 Wynne
Manual Recliner with Drop Arms

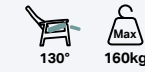

761 Wynne
Electric Recliner with Drop Arms

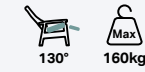

770 Wynne
Manual Recliner with Fixed Arms

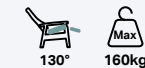

771 Wynne
Electric Recliner with Fixed Arms

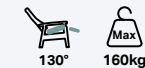

Wood Finish Options

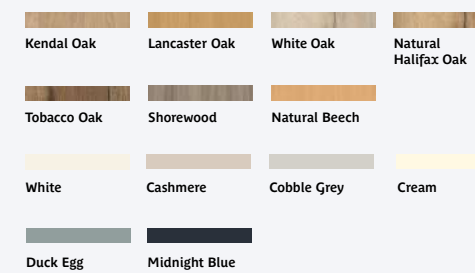

Height adjustable armrest



Medicote™ anti-bacterial finish



Easy to use hand controller

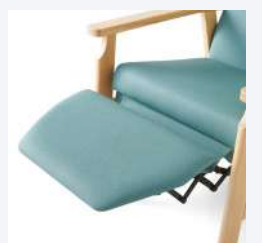

Adjustable footrest

Create truly configurable spaces with flexible beam and modular seating options for waiting and reception areas.

Specify 2,3 or 4 seats with plastic, soft PU, fully upholstered or beautiful wood finish options. Fold-away models also available where space is limited.



Waiting+ Atrium



Multiple vinyl / fabric upholstery options & colours available
see pages 30-31 for further information

See pages 314-316 for
product dimensions

Core Beam



Core Beam Shown with black plastic back & upholstered seat (left) & with fully upholstered seat & back (right)

Core Beam combines simple, timeless modern design with long lasting durability in waiting and outpatient areas. Versatile Core is available with multiple options, including plastic back & seat, plastic back & upholstered seat, upholstered back & seat, with & without arms.

Standard Features

- Steel frame, plastic legs
- Multiple model options, including plastic back and seat, plastic back and upholstered seat, upholstered back and seat
- Black arms
- Maximum load 110kg (17st) per seat

Optional Features

- Plastic back and seat in Black, Grey, Brick or White.
- Floor fixing frame
- Power module (1x USB / 1 x Micro)



CRB-SS Core Beam
2 Unit Seat Beam
Plastic Back, Plastic Seat

CRB-ASSA Core Beam
2 Unit Seat Beam with End Arms
Plastic Back, Plastic Seat



CRB1-ASSA Core Beam
2 Unit Seat Beam with End Arms
Plastic Back, Upholstered Seat

CRB1-SS Core Beam
2 Unit Seat Beam
Plastic Back, Upholstered Seat



CRB2-SS Core Beam
2 Unit Seat Beam
Upholstered Back, Upholstered Seat

CRB2-ASSA Core Beam
2 Unit Seat Beam with End Arms
Upholstered Back, Upholstered Seat



CRB-SSS Core Beam
3 Unit Seat Beam
Plastic Back, Plastic Seat

CRB-ASSSA Core Beam
3 Unit Seat Beam with End Arms
Plastic Back, Plastic Seat



CRB1-ASSSA Core Beam
3 Unit Seat Beam with End Arms
Plastic Back, Upholstered Seat

CRB1-SSS Core Beam
3 Unit Seat Beam
Plastic Back, Upholstered Seat



CRB2-SSS Core Beam
3 Unit Seat Beam
Upholstered Back, Upholstered Seat

CRB2-ASSSA Core Beam
3 Unit Seat Beam with End Arms
Upholstered Back, Upholstered Seat



CRB-SSSS Core Beam
4 Unit Seat Beam
Plastic Back, Plastic Seat

CRB-ASSSSA Core Beam
4 Unit Seat Beam with End Arms
Plastic Back, Plastic Seat



CRB1-ASSSSA Core Beam
4 Unit Seat Beam with End Arms
Plastic Back, Upholstered Seat

CRB1-SSSS Core Beam
4 Unit Seat Beam
Plastic Back, Upholstered Seat



CRB2-SSSS Core Beam
4 Unit Seat Beam
Upholstered Back, Upholstered Seat

CRB2-ASSSSA Core Beam
4 Unit Seat Beam with End Arms
Upholstered Back, Upholstered Seat

At the centre of its design is a highly durable frame and versatile range of accessories. Offering a robust and functional solution that doesn't compromise on style.

Finish Options

Plastic Seat and Back:



Leg Finishes:

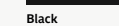

Arm Finishes:



Haywood



Haywood beam seating shown with corner table B3030

With its beautiful beech frame Haywood is a robust, quality modular seating range for waiting and outpatient areas in high traffic public spaces. Multi-seat options available (1-3), with adjoining corner table options.

Standard Features

- Can be arranged in island shapes, corners or formal rows
- Medicote™ antibacterial Beech frame
- Sacral gap as standard for cleaning / access
- Maximum load: 160kg (25st) per seat

Options

- Available with end arms, end and intermediate arms, or without arms
- Internal / external corner seat with upholstered top
- Internal / external corner table
- Bariatric option (**RSHA01**)
- Wood finish options with Medicote™ anti-bacterial lacquer
- Customise from a wide range of fabrics to enhance any space (see pages 30-31)

Wood Finish Options



Designed for high density public seating areas Haywood is easily configurable to suit room layout. This stylish seating is available in a wide range of wipe clean, anti-bacterial upholstery options.



B310-2A Haywood
2 Seater Beam with End Arms

B310-2L Haywood
2 Seater Beam with No Arms



B310-3A Haywood
3 Seater Beam with End Arms

B310-3L Haywood
3 seater beam with No Arms



RSHA01 Haywood
Bariatric Single Seater with Arms 220kg (35st)



B320-2A Haywood
2 Seater Beam With Intermediate Arm And Leg



B320-3A Haywood
3 Seater Beam with Intermediate Arms And Legs



B310A Haywood
Single Seater with Arms

B310L Haywood
Single Seater with No Arms



B330-2 Haywood
2 Seater Beam with Intermediate Leg



B330-3 Haywood
3 Seater Beam with Intermediate Legs



B315 Haywood
Internal / External Corner Seat with Upholstered Top

B3030 Haywood
Internal / External Corner Table



Adeo



A contemporary healthcare waiting and atrium beam seating range with moulded Medipur™ soft PU seats and integral anti-bacterial technology. Simplicity is central to the design, with an easy clean single piece beam making it an ideal choice for high traffic waiting and outpatient areas.

Standard Features

- Moulded Medipur™ PU seats with integral anti-bacterial technology
- Easy clean, strong longitudinal single piece beam
- Heavy duty epoxy coated steel frames
- Easy to clean and maintain seats designed for high traffic areas
- Maximum load: 160kg (25st) per seat

Options

- Multi-seat options (2-4)
- Floor fixing option
- Welded arm options - end, intermediate, no arms
- Silver or Black frame
- Bariatric option (**RSAD2-01**, **RSAD2-02**)

Frame Finish Options



Seat colour options:



RSAD2-SS Adeo
2 Seater Beam



RSAD2-ASSA Adeo
2 Seater Beam with End Arms



RSAD2-ASASA Adeo
2 Seater Beam with End and Intermediate Arm



RSAD2-SSS Adeo
3 Seater Beam



RSAD2-ASSSA Adeo
3 Seater Beam with End Arms



RSAD2-ASASASA Adeo
3 Seater Beam with End and Intermediate Arms



RSAD2-SSSS Adeo
4 Seater Beam



RSAD2-ASSSSA Adeo
4 Seater Beam With End Arms



RSAD2-4A Adeo
4 Seater Beam with End and Intermediate Arms



RSAD2-02 Adeo
Bariatric Single Seat Beam with Arms

RSAD2-01 Adeo
Bariatric Single Seat Beam



Orion



A highly configurable and extremely versatile range of seating, Orion offers superb comfort and durability for public spaces and waiting areas. Fully upholstered with a robust tubular steel frame finished in black or silver, with multiple seat and table configuration options. Available with and without arms.

Standard Features

- Multiple configuration seat and table combinations
- Longitudinal single piece beam - easy clean in line with infection control protocol
- PU Arms
- Maximum load: 160kg (25st) per seat

Options

- Floor fixing option
- Table finish options
- Frame finish options
- Available with end arms, end and intermediate arms, or without arms



A180-ASA Orion
Single Seat Beam Seat with Arms

A180-S Orion
Single Seat Beam Seat



A180-ASSA Orion
Two Seater Beam with End Arms

A180-SS Orion
Two Seater Beam



A180-ASSSA Orion
Three Seater Beam with End Arms

A180-SSS Orion
Three Seater Beam



A180-ASSSSA Orion
Four Seater Beam with End Arms

A180-SSSS Orion
Four Seater Beam



A180-TS Orion
Single Seater Beam and Table

A180-TASA Orion
Single Seater Beam with End Arms and Table



RCBB01 Orion
Bariatric Single Seat Beam 320kg (50st)



RCBB02 Orion
Bariatric Single Seat Beam with Arms 320kg (50st)

Table Finish Options



Frame Finish Options



Firenze



T88 Firenze
Side Chair



T89 Firenze
Armchair with PU Arms

Firenze stacking chair, suitable for high traffic public spaces.

Standard Features

- Upholstered seat and back
- Robust tubular steel frame
- Stacks up to 5 high

Frame Finish Options



Tolero Beam



The perfect accompaniment for public waiting and outpatient areas, Tolero beam seating with slim, ergonomically designed posture back is designed for use in hospital and healthcare environments.

Strong, durable high grade tubular metal frame with anti-bacterial easy clean coated finish for infection management. Choose from 2-4 seats, with end and intermediate arm options.



RSTL-SS Tolero Beam
2 Seater Beam



RSTL-SSS Tolero Beam
3 Seater Beam



RSTL-SSSS Tolero Beam
4 Seater Beam



RSTL-ASSA Tolero Beam
2 Seater Beam
with End Arms



RSTL-ASSSA Tolero Beam
3 Seater Beam
with End Arms



RSTL-ASSSSA Tolero Beam
4 Seater Beam
with End Arms



RSTL-ASASA Tolero Beam
2 Seater Beam
with Intermediate and End Arms



RSTL-ASASASA Tolero Beam
3 Seater Beam
with Intermediate and End Arms



RSTL-4SEIA Tolero Beam
4 Seater Beam
with Intermediate and End Arms

Standard Features

- Strong, durable high grade steel frame creates a modern aesthetic
- Modern, slim profile with contoured back mimics curvature of spine for constant support
- Elegant moulded black plastic arms with integral anti-bacterial technology
- Sacral gap as standard for cleaning / infection management
- Easy rise arms assist sit-to-stand movement
- Robust and resilient to commonly used healthcare cleaning systems
- Maximum load: 160kg (25st) per seat
- Black arms as standard

Optional Features

- Available with or without arms
- Frame colour options
- Customise from a wide range of fabrics to enhance any space (see pages 30-31)

Frame colour options:

- Stone
- Onyx
- Anthracite



Tolero Bench



Strong, durable high grade tubular metal frame with anti-bacterial easy clean coated finish for infection management. Choose from 2 or 3 seats, without arms or with end arm options.



RSTL-2S Tolero Bench
2 Seater Bench



RSTL-2SA Tolero Bench
2 Seater Bench with End Arms



RSTL-3S Tolero Bench
3 Seater Bench



RSTL-3SA Tolero Bench
3 Seater Bench with End Arms

Tolero Bench is ideal for staff areas, public waiting and outpatient areas with slim, ergonomically designed posture back designed for use in hospital and healthcare environments.

Standard Features

- Strong, durable high grade steel frame creates a modern aesthetic
- Modern, slim profile with contoured back mimics curvature of spine for constant support
- Elegant moulded black plastic arms with integral anti-bacterial technology
- Sacral gap as standard for cleaning / infection management
- Easy rise arms assist sit-to-stand movement
- Robust and resilient to commonly used healthcare cleaning systems
- Maximum load: 160kg (25st) per seat
- Black arms as standard

Optional Features

- Available with or without arms
- Frame colour options
- Customise from a wide range of fabrics to enhance any space (see pages 30-31)



Frame colour options:

- Stone
- Onyx
- Anthracite



Quad



Quad is an easily configurable modular seating range, scalable using a palette of elements to create different room layouts in reception, staff rooms, waiting or outpatient areas.

Standard Features

- 90° curved or straight seat options, end arm(s), curved fabric end seats and wood finish table ends
- Maximum load 160kg (25st) per person

Optional Features

- Full back or sacral gap model
- Customise from a wide range of fabrics to enhance any space (see pages 30-31)



Installation

- Please contact Teal Customer Services to arrange a site survey
- Quad requires on-site installation. MOQ of two units per order

Leg finishes:



Example configurations:

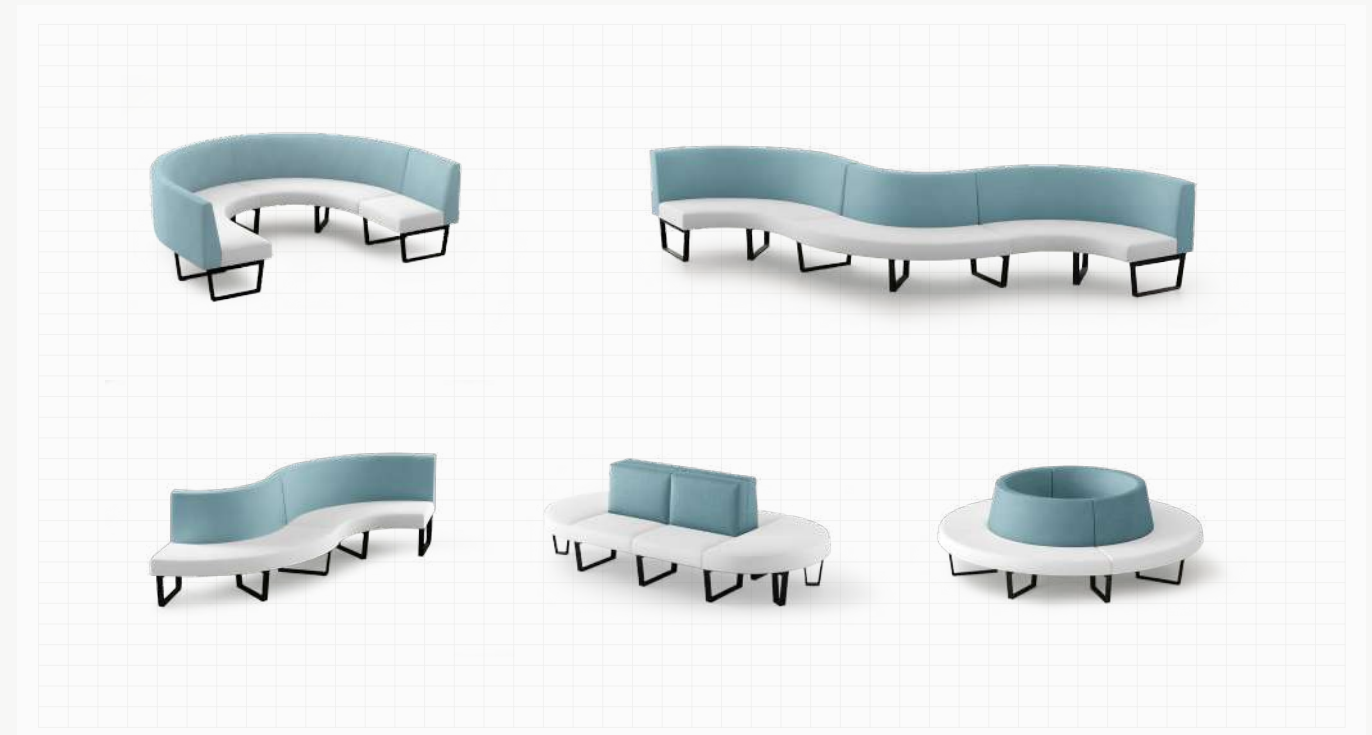

Full back models:



Full back & Sacral Gap Models:

- 650w Seat Unit
- 1300w Seat Unit
- Internal 90° Corner Unit
- External 90° Corner Unit

End Options:

Note: Arm, Table and Semi-Circular End Seat only available on full back models not sacral gap models:

- End Arm Unit
- 650w Semi-Circular End Seat
- 1300w Semi-Circular End Seat
- Semi-Circular End Table
- Square Intermediate / End Table



Herbie



Herbie's range of low level tables beautifully compliment the Herbie soft seating collection.



HRB20 Herbie
Side Chair



HRB70 Herbie
2 Seater Sofa



HRBCT06RD Herbie
Round Coffee Table

Dia: 600
H: 520



HRBCT1007SR Herbie
Rectangular Coffee Table

W: 1000
D: 700
H: 520

Herbie makes a statement in reception or staff breakout areas, with its sculptured seat and back design and distinctive solid Ash underframe. Available with matching circular and rectangular coffee table options.

Coffee Table Features

- MFC top in White, Strata Oak, Winter Oak, Urban Maple & Light Grey
- Solid Ash frame stained in an Oak or Black finish

MFC Finishes



Solid Ash Frame Finishes



Chair Features

- Fully upholstered plywood shell
- Solid Ash 4 leg frame stained in an Oak or Black finish



Inverto



Inverto is a contemporary fold-away beam seating system for use in reception or corridor areas where space is at a premium. Blending sustainable elements with a simple single piece beam, Inverto is easily cleaned for infection control.

Standard Features

- Tip up seat
- Longitudinal single piece beam
- Lacquered wood

Options

- Multi-seat options (2-5)
- Floor fixing option



RSIV01
2 Seater Tip-Up Beam

RSIV03
4 Seater Tip-Up Beam



RSIV02
3 Seater Tip-Up Beam

RSIV04
5 Seater Tip-Up Beam

Earl

Simple and deliberately understated styling is the hallmark of Earl. This carefully considered upholstered piece can be combined in a multitude of configurations to create the perfect solution for reception, atrium and breakout areas.



ERL1 Earl
Armchair



ERL2 Earl
2 Seater Sofa

ERL3 Earl
3 Seater Sofa

Standard Features

- Fitted back cushions
- Fully upholstered
- Square tube frame finished in Black powder coat

Optional Features

- Square tube frame available in Silver or White powder coat
- Multi-fabrics

Concha

Concha is offered in a contoured shell shaped upholstery that combines elegance with comfort. Stylish, robust range of multi-purpose seating suitable for reception or staff areas.



CH1 Concha
Fully Upholstered
Tub Chair



CH2 Concha
Fully Upholstered
Double Tub

Standard Features

- Traditional carcass construction
- Fully upholstered
- Plastic glides

Optional Features

- Two-tone upholstery

Lola

Lola is perfect for stunning reception areas or for creating relaxing spaces in breakout areas.



A821 Lola
Armchair



A822 Lola
2 Seater Sofa

Standard Features

- Moulded foam construction
- Fully upholstered
- Tubular Steel frame

Optional Features

- Multi-Fabrics
- Standard Silver M04 Chrome option

Designed to meet the diverse needs of the healthcare office and ward environment with desking, office chairs and storage solutions - including cupboards, cloakroom equipment and lockers in a range of shapes and sizes.



Office+ Multi-purpose Solutions



Multiple vinyl / fabric upholstery options & colours available

See page 317 for
product dimensions

Harlen Multi-purpose



With uncompromising strength and durability as the key drivers of its design Harlen features moulded polyurethane seat and back which offers high levels of infection control for clinical spaces. Optional castors for safety on hard or soft floor coverings.

Standard Features - Task Chair

- 50mm hard wheel castors
- Polyurethane seat
- Polyurethane, height adjustable back
- Standard mechanism with back locking function

Standard Features - Draughtsman Chair

- Polyurethane seat
- Glides
- Adjustable footring
- Polyurethane, height adjustable back
- Standard mechanism with back locking function

Standard Features - Stool

- Gas height adjustment

Options

- Castors for hard and soft floor coverings

Suitable for a wide range of environments Harlen is available in a range of stools, multi-purpose chairs and height adjustable draughtsman stools.



SFHA05 Harlen
Stool Round Seat



SFHA06 Harlen
Stool Square Seat



SFHA01 Harlen
Side Chair Round Seat & Back



SFHA02 Harlen
Side Chair Square Seat & Back



SFHA03 Harlen
Draughtsman Chair
Round Seat & Back



SFHA04 Harlen
Draughtsman Chair
Square Seat & Back

Seat & Back Finishes

Black (Polyurethane)

Base Finishes

Black (Plastic)



Saturn



Delivering the solution to support everyday work and wellbeing, Saturn is a new adaptable and functional range of office chairs, with pyramid style base for easier floor cleaning.

Standard Features

- Plastic base
- 50mm hard wheel castors for carpet*
- Gas lift
- 5 star Black plastic base*
- Upholstered seat and back

Options

- Standard or Independent mechanism
- Draughtsman height gas lift, adjustable foot ring and glides
- Soft castors for vinyl floor coverings*
- Available in a wide range of finishes

*Selected models only



Draughtsman chair, glide feet (not castors) and no arms for safety reasons

STN10D Saturn
Draughtsman Chair

Glides, Adjustable Foot Ring
No Arms
Medium, Height Adjustable Back
Standard Mechanism



STN10V Saturn
Side Chair

Black Cantilever Frame
No Arms
Medium Back



STN10VA Saturn
Armchair

Black Cantilever Frame
Fixed Arms
Medium Back



STN10 Saturn
Task Chair

50mm Hard Wheel Castors
No Arms
Medium, Height Adjustable Back
Standard Mechanism
with Back Lock function



STN10A Saturn
Task Chair

50mm Hard Wheel Castors
Fixed Arms
Medium, Height Adjustable Back
Standard Mechanism
with Back Lock function



STN10HA Saturn
Task Chair

50mm Hard Wheel Castors
High Adjustable Arms
Medium, Height Adjustable Back
Standard Mechanism
with Back Lock function

Simple in design, yet effective in comfort. Saturn is the new adaptable and functional range of office chairs.



STN16 Saturn
Task Chair

50mm Hard Wheel Castors
No Arms,
Medium, Height Adjustable Back
Independent Mechanism (allows
separate seat & back adjustment)
with Seat & Back Lock function



STN16A Saturn
Task Chair

50mm Hard Wheel Castors
Fixed Arms
Medium, Height Adjustable Back
Independent Mechanism (allows
separate seat & back adjustment)
with Seat & Back Lock function



STN16HA Saturn
Task Chair

50mm Hard Wheel Castors
Height Adjustable Arms
Medium, Height Adjustable Back
Independent Mechanism (allows
separate seat & back adjustment)
with Seat & Back Lock function



Continued on next page

Saturn



STN50 Saturn
Task Chair

50mm Hard Wheel Castors
No Arms
High, Height Adjustable Back
Standard Mechanism
with Back Lock function



STN50A Saturn
Task Chair

50mm Hard Wheel Castors
Fixed Arms
High, Height Adjustable Back
Standard Mechanism
with Back Lock function



STN50HA Saturn
Task Chair

50mm Hard Wheel Castors
Height Adjustable Arms
High, Height Adjustable Back
Standard Mechanism
with Back Lock function



STN56 Saturn
Task Chair

50mm Hard Wheel Castors
No Arms
High, Height Adjustable Back
Independent Mechanism (allows
separate seat & back adjustment)
with Seat & Back Lock function



STN56A Saturn
Task Chair

50mm Hard Wheel Castors
Fixed Arms
High, Height Adjustable Back
Independent Mechanism (allows
separate seat & back adjustment)
with Seat & Back Lock function



STN56HA Saturn
Task Chair

50mm Hard Wheel Castors
Height Adjustable Arms
High, Height Adjustable Back
Independent Mechanism (allows
separate seat & back adjustment)
with Seat & Back Lock function

Upholstery colour options in office soft fabric

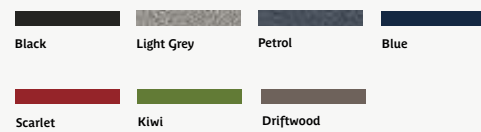

Upholstery colour options in wipeable vinyl for clinical spaces

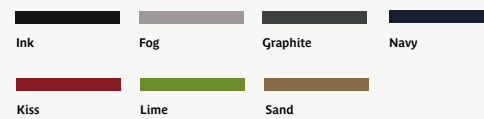

Task Seating / Base Components



Orthopaedica



Orthopaedica is a comprehensive range of ergonomically responsive task seating designed to meet the challenging conditions found in today's healthcare environment. The extra comfort offered by Orthopaedica makes it an ideal all day desk chair.

Standard Features

- 5 star black plastic base
- Black Plastic components
- 60mm hard wheel castors
- Height adjustable ratchet back
- Independent mechanism with seat and back locking function
- Height adjustable arms (except **OC97**)
- Fully upholstered inner back

Options

- 50mm seat depth adjustment
- Polished Aluminium base
- Multi-fabrics
- Inflatable lumbar support
- Inflatable thoracic support
- AirTech seat
- Coccyx cut out
- Multi-functional arm pad

- Soft castors or castors which brake when loaded or unloaded for safety on hard floors

Please note: additional model options available. Please ask for further details.



OC97 Orthopaedica
No Arms



OC97FDA Orthopaedica
Fold Down Arms



OC97HA Orthopaedica
Height Adjustable Arms

Aspen

A standalone office desk is an essential element of an office workspace, providing a dedicated area for tasks, organisation and productivity.

Cantilever



Aspen Standalone Office Desk

- AS10 - W: 1000 x D: 800
- AS12 - W: 1200 x D: 800
- AS14 - W: 1400 x D: 800
- AS16 - W: 1600 x D: 800
- AS18 - W: 1800 x D: 800
- Height - 730

All measurements in mm

Standard Features

- 25mm MFC, rectangular top
- Structural modesty panel
- Porthole cable access
- Cantilever frame with levelling feet

Aspen Optional Features

- Desk extension
- Full fabric rectangular and wave screens
- Cable riser
- Monitor arms
- PU Desk accessories

MFC Top Finishes

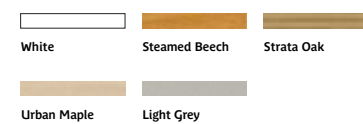

Metal Frame Finishes



Quad



Aspen Standalone Office Desk

- ASQD10 - W: 1000 x D: 800
- ASQD12 - W: 1200 x D: 800
- ASQD14 - W: 1400 x D: 800
- ASQD16 - W: 1600 x D: 800
- ASQD18 - W: 1800 x D: 800
- Height - 730

All measurements in mm

Standard Features

- 25mm MFC, rectangular top
- Structural modesty panel
- Porthole cable access
- 4 Leg frame

- Desk top accessories
- CPU holders
- Electrical accessories
- Choice of finish options available

Designed to accommodate the needs of the every day working office, with ample workspace and cable management making it an indispensable piece of furniture in the office space.

Desk Assembly:

Please contact Teal Customer Services or your Area Manager to find out about desk assembly.



Aspen Height-Adjustable Desk

Height-adjustable desks have become a game-changer in the modern workspace, offering a plethora of benefits that contribute to both employee Wellbeing and overall productivity.

Height Adjustable



ASAE1208 Aspen Rectangular Office Desk

1200 x 800

ASAE1408 Aspen Rectangular Office Desk

1400 x 800

ASAE1608 Aspen Rectangular Office Desk

1600 x 800

All measurements in mm

Electric Height adjustable between **650 - 1300**. Fixed top, not sliding.

Standard Features

- Steel legs
- Scalloped cable access
- 25mm, MFC rectangular top

Optional Features

- Desk mounted cable tray
- Cable risers

MFC Top Finishes

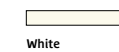

Metal Frame Finishes



The versatility of these desks allows individuals to easily switch between sitting and standing positions, promoting better ergonomics and reducing the risks associated with prolonged sitting.

Freeway



Freeway is a range of desking that offers a simple yet practical working solution. This versatile range gives a strong clean image in a crisp design which delivers intelligent results.

Standard Features

- Fabricated Steel legs
- Steel crossrail
- Levelling feet
- Scalloped cable access
- 25mm MFC rectangular tops
- Modesty panel



Idea Starter 1
1 Person Standalone



Idea Starter 2
1 Person Desk



Idea Starter 3
2 Person In-Line Desk

Freeway Bench is available to order as set configurations or standalone, in line or back to back benches for ease of specifying or alternatively Freeway can be ordered as individual components for added configurability.



Idea Starter 4
4 Person Back to Back Desk



Idea Starter 5
4 Person Back to Back Desk + Meeting Table

800 Top depth
730 Height

Pedestals

Steel or MFC options to compliment desk colours



W: 391
D: 565
H: 605

METMP Tall Mobile (Steel)
3 Drawers (Locking Top Drawer)

Bow Fronted
Three Drawers
Pen Tray Included



W: 430
D: 575
H: 630

CONMP Tall Mobile Pedestal (MFC)
3 Drawers (All Drawers Lock)
Three Foil Drawer Tall Mobile Pedestal

Optional Pen Tray (**CONPTM**)

MP Tall Mobile Pedestal (MFC)
Heavy Duty Version
Includes Pen Tray
3 Steel Drawers

Locking Bar, Anti Tilt and Drawer Selector Device



W: 391
D: 565
H: 605

SLM3 Tall Mobile Pedestal (Steel)
with 3 Drawers

Pen Tray Included

Array



In today's fast-paced world multi-use spaces have become common. People work, meet and collaborate all in the same location. Array has been designed with this in mind. Whether you're conferencing or training, Array is adaptable so you can think, learn and work with ease. Array is available in four additional top shapes; Trapezoidal, Crescent, Polygon and Semi-circular. In addition to this, three Quadrants are also available that seamlessly clip onto any rectangular Array mobile tables.

Whatever your requirements Array can easily adapt to your needs.

'C' Leg Configurations:



Rectangular

W: 1200 – 1800
D: 600 & 750

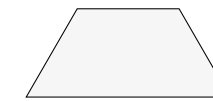

Trapezoidal

W: 1500
D: 750

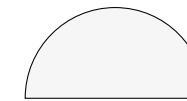

Semi-circular

W: 1500
D: 750

'I' Leg Configurations:



Rectangular

W: 1400 – 2400
D: 750 & 900

Link Top Configurations

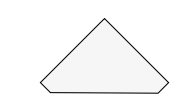

Quadrants (frameless)

Angle: 30°, 45° & 90°
D: 600 & 750mm

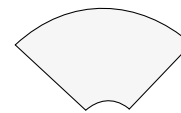

Crescent 120°

W: 1700
D: 750

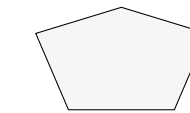

Polygon

W: 1400 - 1650
D: 600 & 750

H: 740

All measurements in mm

Array allows you to design multiple configurations to create your own individual environment.

The table comprises of 2 end legs, 1 central beam, 2 outriggers and 1 synchronising handle, 25mm thick MFC top.

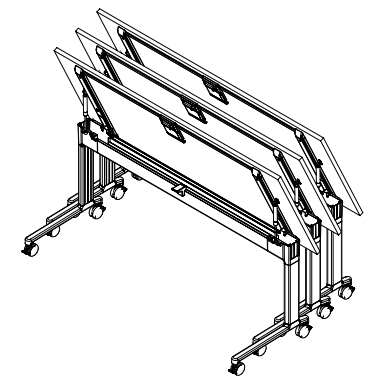

Flip top for nesting of tables and ease of storage.

Standard Features

- Rigid cast Aluminium frame
- Full integrated cable management
- Fully lockable brake castors
- Nesting capabilities
- Gas assisted lift operation
- Single handle to unlock
- Integrated flexible swipe-in cable risers
- 25mm MFC tops

Optional Features

- Below desk power complete with flip access
- In-surface power unit
- Flip in-surface power unit
- Quadrants
- Modesty panels
- Aluminium cable riser
- Linking

Gas assisted lifting mechanism and the ability to provide on desk or in desk power if required.

Frame / Leg Finishes



ARC1407RC
'C' Leg
1400 x 750
Other sizes available



ARC1507HR
'C' Leg
1500 x 750
Half Round Table



ARC1507TP
'C' Leg
1500 x 750
Trapezoidal



ARI1407RC
'I' Leg
1400 x 750
Collaborative

'I' leg allows people to be seated on all sides. Available in two depths 750 and 900 and a range of widths.



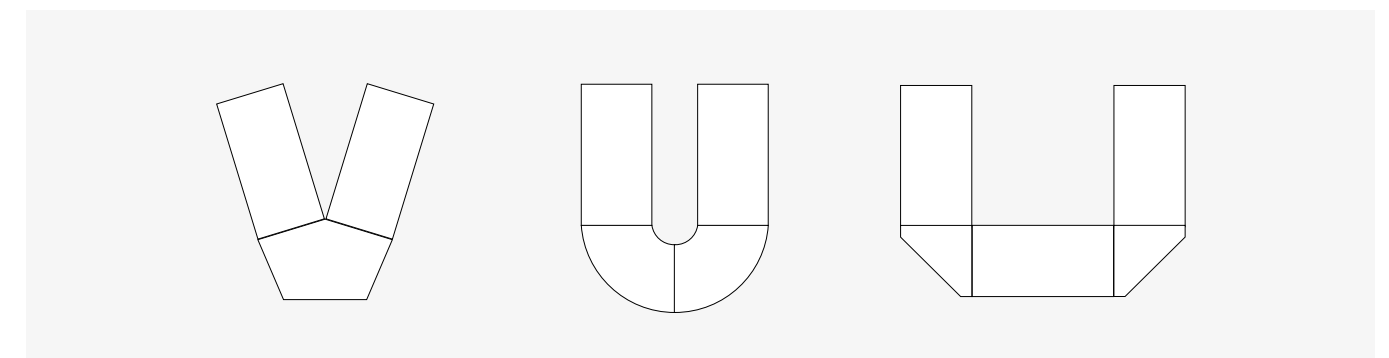

Configuration examples:



Pivot



Range of top shapes including: Square, Rectangular, Trapezoidal and Semi-circular.

			
Square	Rectangular	Trapezoidal	Semi-circular
W: 750 D: 750	W: 1500 / 1800 D: 750	W: 1500 D: 750	W: 1500 D: 750
Standard Height: 730 All measurements in mm			

Pivot tables allow for individual use, small groups or into larger more diverse configurations and function layouts. Can be reconfigured easily with its one touch release mechanism which allows the top to be easily folded.

Pivot tables actively adapt and change with the needs of today's training, meeting and conference environments.

Standard Features

- 25mm MFC top
- Quick release folding mechanism with auto engagement
- Steel frame with low profile cast aluminium foot
- Black 40mm castors with manual brake
- Top to top linking

Performance Standards

- BSEN15372 2008
- BSEN527, Part 1, 2011
- BSEN9241 Part 5, 1999

Frame / Leg Finishes

Silver

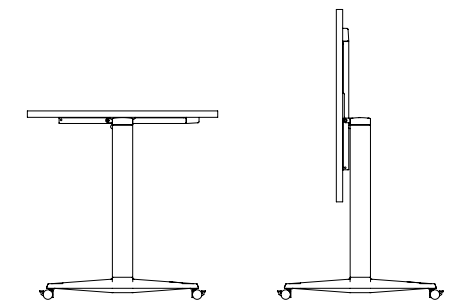

HP75Q
Square
750 x 750

HP7RC
Rectangular
1500 x 750

HP7SC
Semi-circular
1500 x 750

HP7T3
30° Trapezoidal
1500 x 750 x 750

HP7/18RC
Rectangular
1800 x 750

Configuration examples:

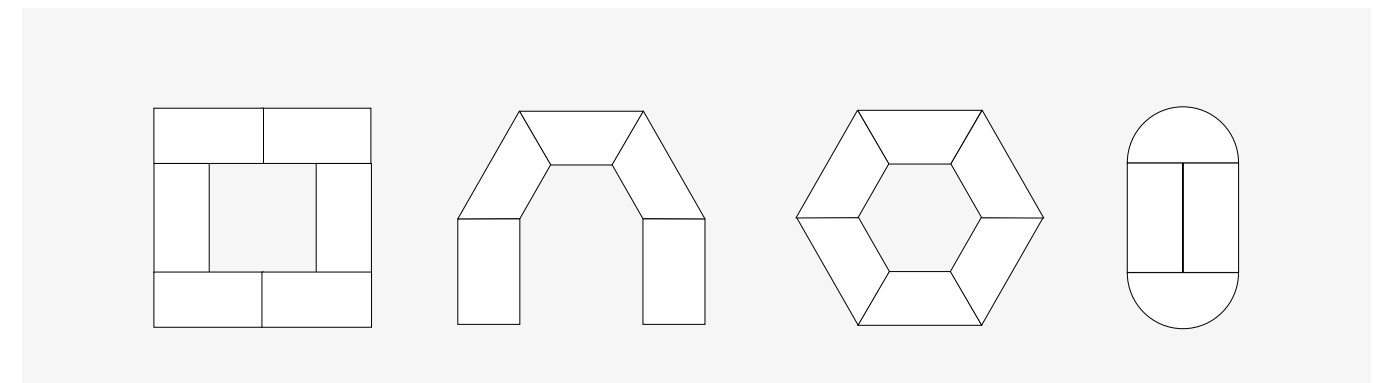

Harley & M12 Folding Table



Range of top shapes including: Square, Rectangular, Trapezoidal, Semi-circular and Circular.

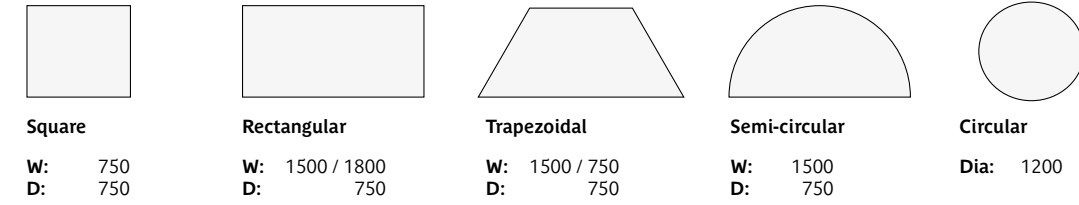

Standard Height: 730
All measurements in mm

Frame / Leg Finishes



Note: additional charge applies for Silver / Polished Chrome



Part of the popular meeting and training tables collection, Harley is a modular table range, easily configured to suit the available space. Tubular steel or wood quick release leg options.

Standard Features

- 25mm MFC tops in a range of top shapes
- Modular 4 leg tables
- 60mm diameter legs can be powder coated or Chrome plated
- Adjustable levelling feet

Optional Features

- Tubular steel or wood quick release legs
- Wood leg option provides a more traditional aesthetic, suited to a conference or boardroom arrangement. Wood legs available in clear lacquer

Configuration examples:

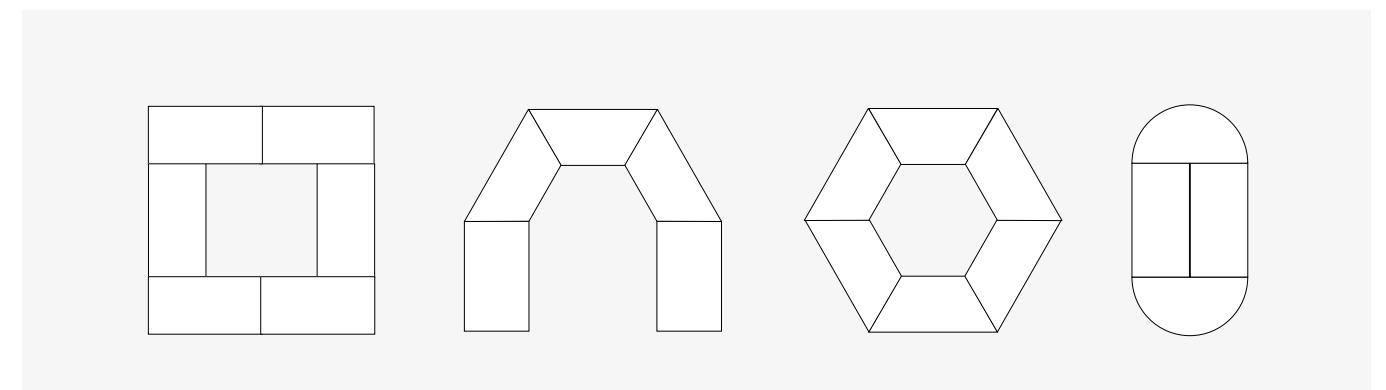

M12 Folding Table



M12 Folding table (MFC Top)
1500 x 750
(Folds flat and stacks)

Frame / Leg Finishes



Note: additional charge applies for Silver / Polished Chrome

MFC Top Finishes; Light Grey, Strata Oak, Urban Maple, White, Winter Oak

Play Storage



Play Storage provides your workspace environment with a great storage solution that can house open drawers, shelves and lockers. With an infinite number of possible combinations, you can have a modular storage solution which is truly unique to you.

Standard Features

- Matching grain direction
- Lower storage internal shelf
- Rigid steel frame with levelling feet (all frames must be ordered separately)

PYP18-8-DRO Model only:

- Aluminium cast handles in black
- Double open storage shelves above

Optional Features

- Wide range of colour options available

Please note additional model options available. Please ask for further details.



PYP18-8-DRO
Open Storage

W: 825
D: 440
H: 1770



PYP12-8-4LU-DL
Two High Locker
Four lockers with digital combi locks

W: 825
D: 440
H: 1250



PYP7-8-2LU-DL
Cupboard Storage
Two lockers with digital combi locks

W: 825
D: 440
H: 730

Universal Storage

Universal Storage has been developed away from the traditional filing system to respond to changing storage needs.



S160F-KD Tambour Unit
Open Front Shelf Unit 3 Shelves
(Other size options available up to 2000mm height)

W: 1000
D: 500
H: 1600

Please note:
Requires wall fixing

Universal storage- 730, 1200, 1600 and 2000 open fronted, two door or space saving, side sliding, tambour fronts to save space. Each unit comes complete with the required standard shelves. Specialist shelves such as lateral hanging or pull out lateral hanging can also be added. Heights of 1600 and over require on site assembly.



S7-15DR Universal Storage
3 Door Storage Unit, Lockable

W: 1500
D: 500
H: 730



S7DR Universal Storage
2 Door Storage Unit, Lockable

W: 1000
D: 500
H: 730



All measurements in mm



Lockers

Teal lockers incorporate a range of unique features that make it one of the most stylish and adaptable lockers available. Manufactured from robust 0.9mm and 0.7mm thick steel.



1-6 door options

Locker columns with flat or sloping tops from one door to 6 doors per column 1800 high (1950 high with sloping tops).

Available In a variety of locker Sizes:

Height: 1800
 300 wide x 930, 380 or 450 deep,
 380 wide x 380 or 450 deep,
 450 wide x 450 deep

Various lock options from Hasp locks for use with personal padlocks, key / cam locks, mechanical and electrical digi code lock options.



Door and body colour options:

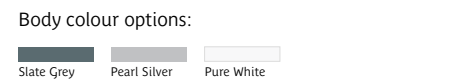
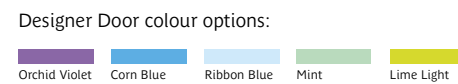
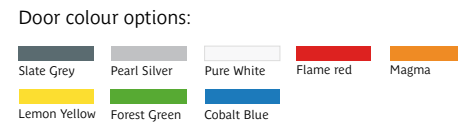

Standard Features

- Carbon zero manufacturing
- Doors vented aiding air flow
- Through frame locking
- Flamezero certificated
- Made in Britain
- High quality UK locks
- Fully recyclable
- Robust .9mm & .7mm thick steel
- Covid safe finish - bioshell
- Offset rivets on all products
- Anti-intruder frame
- Tested to BS standards

Specialist Lockers



Specialist wall fixed charging lockers

Size: 300 wide x 300 deep with [8, 10 or 15 compartments] for phones and lap tops, available with individual doors or single doors for fast access.

Vented to prevent build up of heat and available with 240volt, USB-A or USB-c or a combination as well as multiple cable outlet options.

All measurements in mm

Seats & Locker stands



Available with stands, stands with seats or as free-standing cloakroom benches and hangers

In some situations it is a requirement that staff can clean under lockers to prevent a build up of dirt and debris. This can also ease access to the bottom locker compartment. We can supply stands to lift the locker body from floor level. Usually 150mm high and fitted with adjustable feet to counteract uneven floors, these stands can be supplied in multiple locker widths to save cost and make installation easier.

Not all changing rooms have the available space to accommodate separate changing benches. To contend with this, we can supply a combined bench seat and stand. Benches have solid wood slats, can be manufactured in multiple locker widths and have the added benefit of allowing cleaning under the lockers.



Twin Locker



Includes top shelf and two separate hanging compartments each with a coat hook.

Pure Steel Twin Lockers offers two slimline lockers, each with a top shelf and larger hanging area.

- Features a handy top shelf, ideal for keeping smaller items safely stored as well as a larger compartment for hanging items of clothing
- Ideal for use in a range of environments where you may not have the floorspace for larger individual lockers
- Robust 0.7mm & 0.9mm all steel construction and anti-intruder frame
- Finished with a durable powder coat for ultimate longevity



16 Door Lockers

These personal effects lockers are perfect for offering secure storage for small personal possessions such as garments, wallets, purses, mobile phones & keys.

- Ideal for use in a range of environments where you may not have the floorspace for larger individual lockers
- Robust 0.7mm & 0.9mm all steel construction and anti-intruder frame
- Finished with a durable powder coat for ultimate longevity

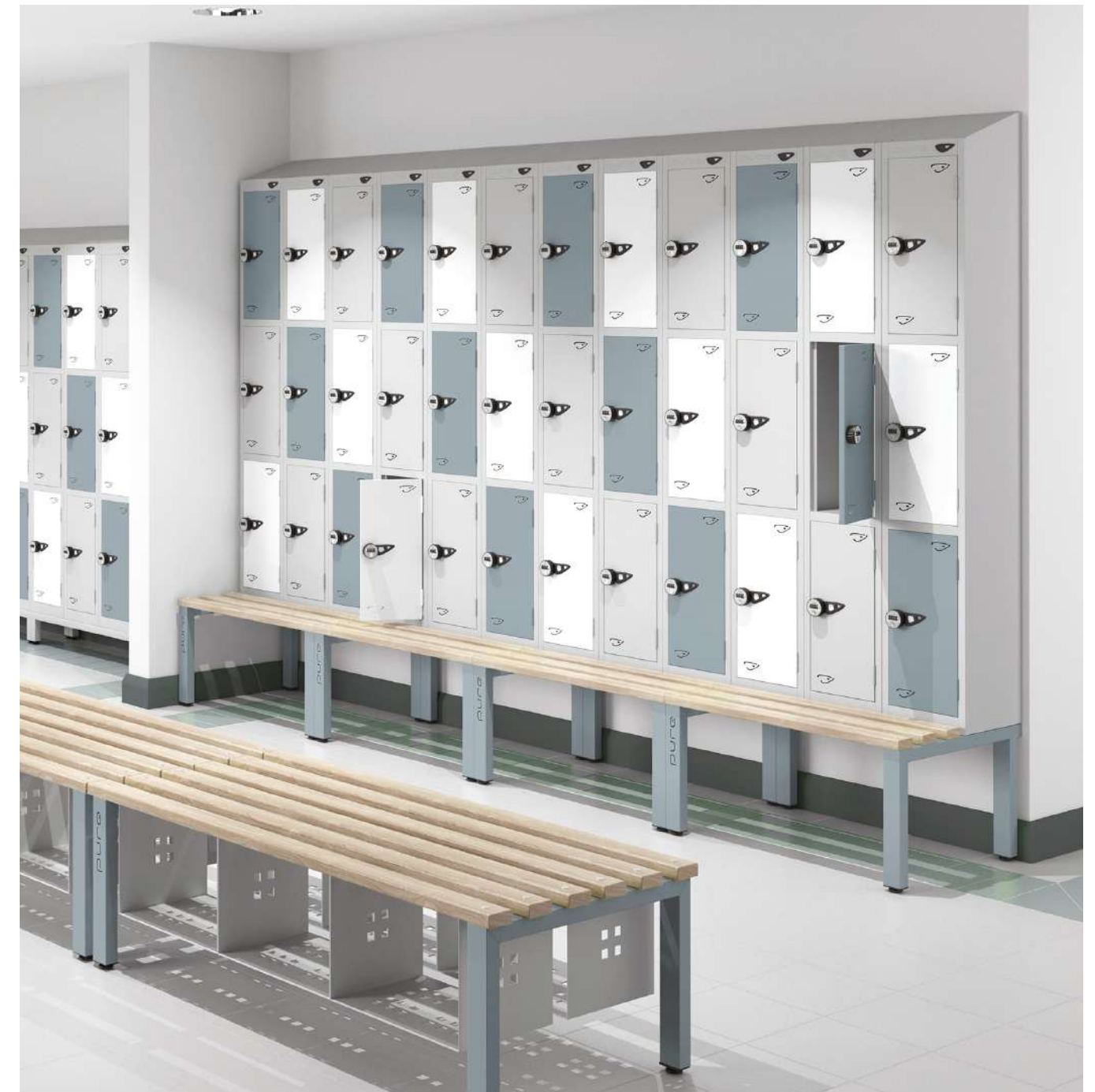

Integral sloping tops



Clothing, rubbish and food left on top of lockers can be both a health and fire hazard. Our innovative sloping top design eliminates that unsightly gap at the top of the locker that can allow dirt and bacteria to accumulate. Not only does this design look better but it will be of particular benefit in sterile environments. Retro fit sloping tops also available.



Plastic slope top



Steel slope top

H: 150

Our soft seating collection epitomises comfort and style with contemporary and classic designs to suit any interior space, with detailing options to add a design touch.



Durable and resistant to abrasion, a range of stain resistant, waterproof and anti-microbial contract fabrics are available, including vinyl / faux leather and fabric upholstery options.



Multiple vinyl / fabric upholstery options & colours available
see pages 30-31 for further information

See pages 317-321 for
product dimensions

Sofas+ Armchairs

Upholstery Detail

Our soft seating ranges are available with a variety of different upholstery style details, to suit different individual spaces.

Back Cushion Options:



Plain



Single Button



Multi Button



Fluted



Quilted



Piped

Please note the options shown above are not available on all models.
Please contact customer services for more details.

Seat Foam Options:

Standard foam

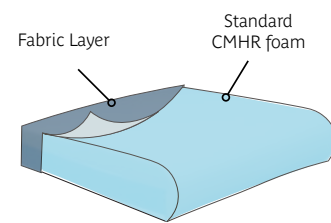

Comfort foam

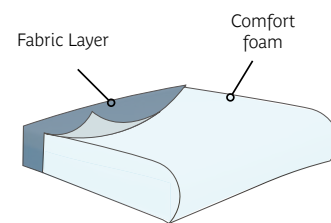

BB pressure relief seat

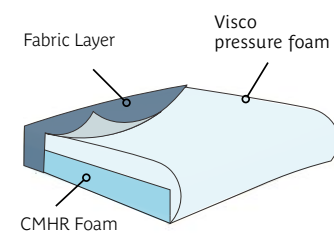

Medium to high risk Reflexion® Visco pressure foam to facilitate blood circulation and distribute weight evenly.

Wood Finish Options:

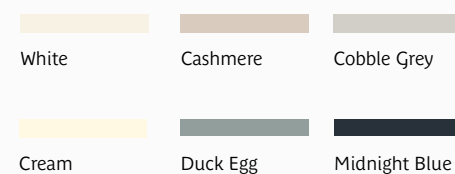
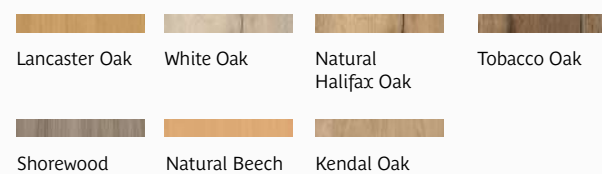

Evoke



With a dementia-friendly ergonomic design to help maintain independence and dignity, Evoke guides the user into the correct seating position with ease, whilst offering lumbar and thoracic support.

Standard Features

- Lumbar and thoracic support for comfort
- Tapered seat platform
- Arms offer sit-to-stand leverage
- Medicote™ anti-bacterial lacquer

Optional Features

- Piping
- Fluting
- Buttons
- Quilted back
- Wood finish options (see page 33)
- Customise from a wide range of fabrics to enhance any space (see pages 30-31)



Galloway & Pimlico



Galloway seating family and Pimlico LSPI02 high back armchair shown with Sunda 2 SUN201 coffee table

Galloway and Pimlico bring a seamless blend of comfort and contemporary elegance. At home in a myriad of spaces: lounges, waiting rooms and break out areas, this welcoming curved back chair is designed to enhance posture and optimise seating position promoting wellbeing. Well situated arms assist mobility.

Standard Features

- Containment wings on Galloway Curve and Pimlico models
- Matching footstool available (**SSGA05**)
- Medicote™ anti-bacterial lacquer
- Flowing design with rounded corners

Optional Features

- Piping
- Fluting
- Buttons
- Comfort seat
- BB pressure relief seat
- Plus+ one piece cover, fully sealed to prevent concealment and aid cleaning*
- Wood finish options (see page 33)
- Customise from a wide range of fabrics to enhance any space (see pages 30-31)

*only available on selected fabrics & vinyl's with strengthened seams



LSPI02 Pimlico
High Back Armchair with Wings & Removable Seat



SSGA04 Galloway Curve
High Back Armchair with Wings



SSGA03 Galloway
High Back Armchair

LSPI01 Pimlico
High Back Armchair with Wings & Fixed Seat



SSGA01 Galloway
Mid Back Armchair



SSGA02 Galloway
Mid Back 2 Seater Sofa



SSGA05 Galloway
Footstool

Available as an armchair or 2 seater sofa. Customise from a wide range of fabrics and finishes to enhance any space.

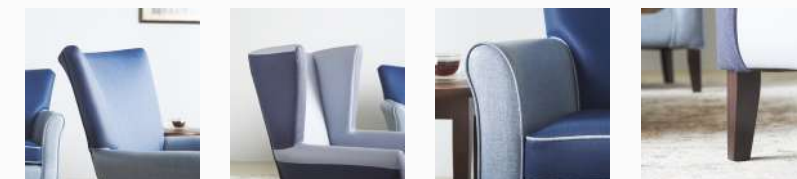

Brunswick

With elegant turned arms and splayed, deep fluted back, the Brunswick exudes timeless charm. Placing design focus on posture and comfort, Brunswick is a favourite for residential and clinical lounges and TV rooms.



SSBR01 Brunswick
High Back Armchair

Christie



Christie seating family shown with Bexley TCBE-600RD round coffee table

Flexible and eminently usable in a myriad of spaces, the Christie has a generous seat and curved supportive back making it a very popular range. Available as a low, mid and high back chair, or as a tub or sofa, Christie has a fixed or removable seat.

Standard Features

- Distinctive, contemporary styling
- Robust, durable easy chair
- Curved, supportive back
- Generous seat width
- Medicote™ anti-bacterial lacquer

Optional Features

- Fixed or removable seat
- Piping
- Comfort seat
- BB pressure relief seat
- Wood finish options (see page 33)
- Customise from a wide range of fabrics to enhance any space (see pages 30-31)



TSCH21 Christie
Low Back Armchair



TSCH22 Christie
Mid Back Armchair



TSCH23 Christie
High Back Armchair



TSCH24 Christie
Mid Back 2 Seater Sofa



TSCH25 Christie
Tub Chair

A total chameleon, the Christie changes personality with each different selection of wood and upholstery finish.



Olivia

Olivia is a beautiful seating solution for any space. A distinctive, contemporary yet retro-inspired silhouette features soft contoured edges and deep filled back, arm and seat cushions for supreme comfort.



Olivia seating family shown with Sunda SUN201 round coffee table

Olivia creates an inviting seating area that defines its surroundings.



SSOV01 Olivia
Armchair
Shown with
Fixed Seat Option



SSOV02 Olivia
2 Seater Sofa
Shown with
Fixed Seat Option



SSOV03 Olivia
3 Seater Sofa
Shown with
Fixed Seat Option

SSOV21 Olivia
Armchair
with Looped
Leg Underframe

SSOV22 Olivia
2 Seater Sofa
with Looped
Leg Underframe

SSOV23 Olivia
3 Seater Sofa
with Looped
Leg Underframe

With consideration for comfort and modern aesthetic Olivia combines elements of design with functionality - with contrast metal underframe available in a range of colours, stylish shaped arms and both fixed and removable seat options.



Olivia SSOV22 2 seater sofa and Olivia SSOV21 armchair with looped leg

Standard Features

- Stylish metal underframe
- Distinctive, contemporary aesthetic

Optional Features

- Fixed or removable seat options
- Plus+ one piece cover, fully sealed to prevent concealment and aid cleaning*
- Frame colour options: Onyx, Anthracite, Stone
- Customise from a wide range of fabrics to enhance any space (see pages 30-31)
- Bolster cushions

*only available on selected fabrics & vinyl's with strengthened seams



Frame colour options:

- Stone
- Onyx
- Anthracite



Bringing contemporary elegance to any room, Olivia is the perfect enhancement for any space.

Idro



Idro seating family shown with Batan SFM06RD round coffee table

The epitome of contemporary design and comfort with distinctive show wood underframe and deep padded seat, back and arms. The perfect seating for modern environments, including lounge, breakout and waiting areas.

Mandy



Mandy seating family shown with Sunda SUN201 round coffee table

Embracing stylish and compact form, Mandy is a contemporary enhancement to any space: bedrooms, waiting areas and lounges. Mandy is available as an armchair, 2 or 3 seater sofa and sofa bed.



LSID01 Idro
Armchair



LSID02 Idro
2 Seater Sofa

LSID03 Idro
3 Seater Sofa

Standard Features

- Soft fibre back cushions
- Removable seat and back cushions
- Solid Beech show wood underframe
- Medicote™ anti-bacterial lacquer

Optional Features

- Piping
- Buttons
- Comfort seat
- BB pressure relief seat
- Wood finish options (see page 33)
- Customise from a wide range of fabrics to enhance any space (see pages 30-31)



SSMA21 Mandy
Armchair



SSMA22 Mandy
2 Seater Sofa

SSMA23 Mandy
3 Seater Sofa



Standard Features

- Removable seat and back cushions
- Medicote™ anti-bacterial lacquer

Optional Features

- Wood finish options (see page 33)
- Customise from a wide range of fabrics to enhance any space (see pages 30-31)
- Sofa bed options available (see pages 76-77)

Maldiv



Maldiv SSML21 armchair with round arms & SSML22 Maldiv 2 Seater with round arms with Portobello TAP004X coffee table

Contemporary, stylish and comfortable, Maldiv can be customised to enhance any space with a choice of cushion, leg and arm style.

Available as an armchair and 2 or 3 seater sofa.

Maldiv Modular option:

Custom build your own modular seating (including corner units) and create a configuration that perfectly suits your space (see page 200).



SSML26 Maldiv 3 Seater, Corner Unit, 2 Seater; Round Arms



SSML01 Maldiv
Armchair
with Tapered Arms



SSML02 Maldiv
2 Seater Sofa
with Tapered Arms



SSML03 Maldiv
3 Seater Sofa
with Tapered Arms



SSML21 Maldiv
Armchair
with Round Arms



SSML22 Maldiv
2 Seater Sofa
with Round Arms



SSML23 Maldiv
3 Seater Sofa
with Round Arms



SSML31 Maldiv
Large Footstool

Upholstery Options

- Removable seat & back
- Fixed seat & removable back
- Fixed seat & zip fixed back
- Fixed seat & fixed back

Standard Features

- Medicote™ anti-bacterial lacquer

Optional Features

- Leg style; block or skid
- Wood finish options (see page 33)
- Customise from a wide range of fabrics to enhance any space (see pages 30-31)

Linx



Linx single chair & sofa shown with optional arms and **Batan SFM06RD** round coffee table

Linx with soft appearance and feel is characterised by sumptuous levels of comfort. Ideal for lounge, quiet spaces, reception areas, staff rooms.

Standard Features

- Medicote™ anti-bacterial lacquer

Optional Features

- Air piping
- Arms, LHF or RHF (per Arm)
- Arms, pair
- Wood finish options (see page 33)
- Customise from a wide range of fabrics to enhance any space (see pages 30-31)



LNX1 Linx
Single Chair
(Shown with optional arms)



LNX2 Linx
2 Seater Sofa
(Shown with optional arms)

LNX3 Linx
3 Seater Sofa

Linx Modular option:

Custom build your own modular seating (including corner units) and create a configuration that perfectly suits your space. (see pages 198-199).

Athena



Athena seating family shown with **Sunda SUN201** round coffee table

Minimal, simple and slim profiled design with sacral gap; Athena is a contemporary nuanced design suited to modern environments that want to create an airy, welcoming space.

Standard Features

- Slim profiled back for lumbar support
- Sacral gap for ease of cleaning
- Height allows for hoist access (Bottom of leg to underside of seat; front 240mm, rear 200mm)
- Medicote™ anti-bacterial lacquer

Optional Features

- Wood finish options (see page 33)
- Customise from a wide range of fabrics to enhance any space (see pages 30-31)



RSAH01 Athena
Armchair,
Fixed Seat

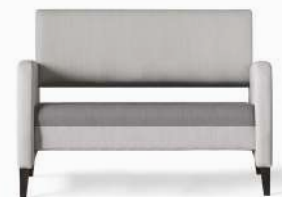

RSAH02 Athena
2 Seater Sofa,
Fixed Seat

Keilder



Keilder seating family shown with Sunda SUN201 round coffee table

Keilder offers a traditional, comfy solution to lounge seating with softly curved padded arms and supportive back. Perfect for two tone upholstery designs. Available as an armchair and 2 or 3 seater sofa.



SSKE01
Armchair



SSKE02
2 Seater Sofa

SSKE03
3 Seater Sofa

Standard Features

- High supportive back and rounded armrests
- Soft fibre back comfort cushions
- Medicote™ anti-bacterial lacquer

Optional Features

- Piping
- Comfort seat
- BB Pressure relief seat
- Wood finish options (see page 33)
- Customise from a wide range of fabrics to enhance any space (see pages 30-31)

Jem

A contemporary statement piece with distinctive silhouette, Jem's generous outer proportions ensure a sense of personal space while the inner profile creates a snug and comfortable seating position.

Available as an armchair, 2 or 3 seater sofa, with matching footstool.



SSJM01X
Armchair



SSJM02X
2 Seater Sofa

SSJM03X
3 Seater Sofa



SSJM04X
Footstool



Standard Features

- Generous proportions
- Designed to give individuals a sense of personal space
- Medicote™ anti-bacterial lacquer
- Plus+ one piece cover, fully sealed to prevent concealment and aid cleaning*

Optional Features

- Wood finish options (see page 33)
- Customise from a wide range of fabrics to enhance any space (see pages 30-31)

*only available on selected fabrics & vinyl's with strengthened seams

Anumo



Anumo SSAU02 sofa shown with Batan SFM06RD round coffee table

Based on the concept of a “hug”, the playful asymmetry and distinctive curves of this versatile range are both cosy and welcoming. Ergonomically designed lumbar support enhances posture.



SSAU01 Anumo
2-Seater Sofa, Piping,
Removable Seat



SSAU02 Anumo
Armchair, Piping,
Removable Seat

Standard Features

- Lumbar support
- Comfort foam as standard
- Seat depth and height enable ease of manoeuvrability
- Medicote™ anti-bacterial lacquer

Optional Features

- Wood finish options (see page 33)
- Customise from a wide range of fabrics to enhance any space (seat cushion and piping only - see pages 30-31)

Due to its curves the back rest can only be upholstered in a stretch fabric or vinyl, please contact Teal for details.

Seat cushion & piping can be upholstered in any fabric.



Designed in collaboration with Ali and Nick Munro.

Roku® Asuka



With a relaxing, calming, and welcoming feel due to a soft and rounded organic appearance, Asuka has a low back, generous seating area and fully sealed single piece upholstered seat.



SSRA01X
Armchair



SSRA02X
2.5 Seater sofa

SSRA03X
3.5 Seater sofa

Standard Features

- Plus+ one piece cover, fully sealed to prevent concealment and aid cleaning*
- Flowing design with rounded corners
- Fixed waterfall seat
- Low profile skid legs
- Medicote™ anti-bacterial lacquer

Optional Features

- Wood finish options (see page 33)
- Customise from a wide range of fabrics to enhance any space (see pages 30-31)

*only available on selected fabrics & vinyl's with strengthened seams

Murano



Fluidity and soft organic curves define Murano, a masterpiece in comfort and style. Murano is available as a 2 seater sofa that would elevate any space.



SSMU02X+
Murano
2 Seater Sofa

Standard Features

- Plus+ one piece cover, fully sealed to prevent concealment and aid cleaning*

Optional Features

- Customise from a wide range of fabrics to enhance any space (see pages 30-31)

*only available on selected fabrics & vinyl's with strengthened seams



Chesterfield



Chesterfield SSCF22 2 seater sofa with SSCF25 Large footstool

With vintage styling, the Classic Chesterfield range has rolled arms and a deep buttoned back. These quintessential features exude elegance and comfort. The Chesterfield is beyond time and trend and enhances any luxurious space.



SSCF21 Chesterfield Armchair



SSCF22 Chesterfield 2 Seater Sofa



SSCF24 Chesterfield Small Footstool

SSCF23 Chesterfield 3 Seater Sofa

SSCF25 Chesterfield Large Footstool

Standard Features

- Scrolled arms
- Deep button back
- Timeless design
- Medicote™ anti-bacterial lacquer

Optional Features

- Wood finish options (see page 33)
- Customise from a wide range of fabrics to enhance any space (see pages 30-31)

Hinchley



Hinchley LSHI23 sofa shown with Sunda SUN201 round coffee table

Hinchley features elegant ornamentation with scrolled arms and turned legs with castors. Beautiful piping detail or two tone fabric options are available from a wide selection of fabric and wood finishes to enhance any space.



LSHI21 Hinchley Mid Back Armchair Removable Seat Cushion



LSHI22 Hinchley High Back Armchair Removable Seat Cushion



LSHI23 Hinchley Mid Back 2.5 Seater sofa Removable Seat Cushion

Standard Features

- Castor front leg
- Comfort seat foam
- Removable seat cushions, fixed back
- Medicote™ anti-bacterial lacquer

Optional Features

- Piping
- Skirt
- Elegant turned front leg

- Wood finish options (see page 33)
- Customise from a wide range of fabrics to enhance any space (see pages 30-31)

Orla



Orla SSOR02 sofa shown with Batan SFM06RD round coffee table

A contemporary take on a vintage style, Orla is based on the classic Chesterfield model with low back and curved sides. These quintessential features exude elegance and comfort. Retro-inspired legs with a modern twist.



SSOR01 Orla
Armchair



SSOR02 Orla
2 Seater Sofa



SSOR03 Orla
3 Seater Sofa

Standard Features

- Supportive-sit sprung fixed seat for extra comfort
- Stylish design with tapered leg shape
- Leg height for hoist access
- Medicote™ anti-bacterial lacquer

Optional Features

- Wood finish options (see page 33)
- Customise from a wide range of fabrics to enhance any space (see pages 30-31)

Marli



Marli seating family shown with Portobello TAP004X coffee table

Marli is a beautiful and eye-catching contemporary seating range. Deep cushion and supportive back afford a comfortable, domestic aesthetic.



SSMR01X Marli
Armchair



SSMR02X Marli
2 Seater Sofa

SSMR03X Marli
3 Seater Sofa

Standard Features

- Contemporary design with elegant curved sides
- Zero depth seam
- Soft, contoured edges with deep filled back, arm and seat cushions for added comfort
- Medicote™ anti-bacterial lacquer
- Plain back as standard
- Hoist access 135mm

Optional Features

- Available with optional quilted back
- Wood finish options (see page 33)
- Customise from a wide range of fabrics to enhance any space (see pages 30-31)

Atlas



Atlas LSAT03 mid back armchair shown with F11 circular coffee table

A robust, durable and comfortable easy chair with contoured supportive high back. Developed for multi-environment use up to high risk security environments.

Standard Features

- Contoured, supportive back
- Robust durable easy chair
- Medicote™ anti-bacterial lacquer
- Leg height for hoist access

Optional Features

- Fixed or removable seat cushions
- Piping
- Comfort seat
- Wood finish options (see page 33)
- Customise from a wide range of fabrics to enhance any space (see pages 30-31)



LSAT01 Atlas
High Back Armchair
with Removable Seat Cushion

LSAT01RS Atlas
High Back Armchair
with Removable Seat Cushion



LSAT02 Atlas
High Back Armchair
with Wings And Fixed
Seat Cushion



LSAT03 Atlas
Mid Back Armchair
with Fixed Seat Cushion

LSAT03RS Atlas
Mid Back Armchair
with Removable Seat Cushion



LSAT11 Atlas
Bariatric Armchair
Fixed Seat, Maximum
User Weight 220kg (35st)



LSAT02RS Atlas
High Back Armchair
with Wings and
Removable Seat Cushion

The Atlas series is available with high or mid back, with loose or fixed seat cushions and with or without wings.



Belgrave

Belgrave with its traditional contours, wings and Queen Anne leg detail is perfect in traditional or formal spaces. Add piping or button detail options and choose a wood finish and upholstery to both enhance the space and achieve advised LRV contrast levels for dementia care.



Standard Features

- Queen Anne leg
- Padded, curved arm
- Removable seat cushion
- Medicote™ anti-bacterial lacquer

Optional Features

- Piping
- Diamond Stitch Back
- Diamond Stitch Back & Buttons
- Comfort Seat
- BB pressure relief seat
- Wood finish options (see page 33)
- Customise from a wide range of fabrics to enhance any space (see pages 30-31)



LSBG02 Belgrave
Armchair



LSBG04 Belgrave
2 Seater Sofa

Velvare Club

A beautiful chair with on-trend qualities including curved form and ergonomically supportive back and arms with adjustable lumbar support. Velvare is perfect for use in patient spaces, maternity units, waiting rooms and lounges.



LSVE05 Velvare Club
High Back Armchair with Headrest



LSVE06 Velvare Club
Mid Back Armchair

Standard Features

- Profiled back with excellent lumbar support
- Distinctive styling
- Removable seat cushion
- Headrest on high back model
- Medicote™ anti-bacterial lacquer

Optional Features

- Inflatable lumbar support
- Wood finish options (see page 33)
- Customise from a wide range of fabrics to enhance any space (see pages 30-31)

Virtuoso



Virtuoso is a statement range of chairs that gets noticed and provides a beautiful accent to any room. Available as a low back, high back or high back with curved wings, and with a fixed or loose seat cushion*, Virtuoso is as comfortable as it is good looking.



LSVR01 Virtuoso
Low Back Armchair



LSVR02 Virtuoso
High Back Armchair



LSVR03 Virtuoso
Ottoman stool



LSVR04 Virtuoso
2 Seater Sofa
*fixed seat only



LSVR05 Virtuoso
Mid Back Armchair



LSVR06 Virtuoso
Footstool

Optional Features

- Wood finish options (see page 33)
- Customise from a wide range of fabrics to enhance any space (see pages 30-31)

Vista



Vista LSVI01 shown with quilted seat & back option

Vista is a versatile chair with a stylish show wood frame and a waterfall seat, developed for multi-environment use in healthcare & care homes, with enhanced specification mental health furniture options for challenging environments if required.

Standard Features

- Distinctive lounge chair
- Show wood frame
- Fixed waterfall seat
- Medicote™ anti-bacterial lacquer

Optional Features

- Quilted seat & back
- Wood finish options (see page 33)
- Customise from a wide range of fabrics to enhance any space (see pages 30-31)



LSVI01 Vista
Mid Back Armchair,
Open Arms



LSVI02 Vista
Mid Back Armchair,
Upholstered Arms



LSVI03 Vista
Mid Back Armchair,
Upholstered Arms
with Handgrips

*Models above shown with quilted seat & back option

Keppler



Fusing elegant laid back angles with exposed wood frame and comfortable back and seat, Keppler is a mid-century modern inspired accent armchair perfect for staff wellbeing, key worker accommodation, reception or lounge areas.



LSKP01 Keppler
Mid Back Armchair

Optional Features

- Wood finish options (see page 33)
- Customise from a wide range of fabrics to enhance any space (see pages 30-31)

Umbria

An elegant, simple and compact profile makes Umbria perfect for multiple environments such as lounges, bedrooms and waiting rooms. Ergonomically positioned back enhances posture and supportive arms allow an easy sit to stand transition.

Standard Features

- Removable seat
- High supportive back
- Medicote™ anti-bacterial lacquer

Optional Features

- Comfort foam
- Piping
- Wood finish options (see page 33)
- Customise from a wide range of fabrics to enhance any space (see pages 30-31)



SSUM01 Umbria
Armchair



SSUM02 Umbria
2 Seater Sofa



Zenda



Zenda LSZE24 Mid back 2 Seater sofa with plain back & piping detail

Standard Features

- Profiled back with excellent lumbar support
- Distinctive styling
- Removable seat cushion
- Solid oak legs
- Medicote™ anti-bacterial lacquer
- Zip fixed back cushion

Optional Features

- Piping
- Quilted back detail
- Quilted back & buttoned detail
- Wood finish options (see page 33)
- Customise from a wide range of fabrics to enhance any space (see pages 30-31)

Zenda is a contemporary designed armchair family, with mid back, high back and two seater options.



LSZE21 Zenda
Mid Back Armchair



LSZE22 Zenda
High Back Armchair
shown with quilted back option



LSZE23 Zenda
High Back Armchair
with Wings
shown with quilted back option



LSZE24 Zenda
Mid Back 2 Seater Sofa
shown with quilted back option



LSZE25 Zenda
High Back 2 Seater Sofa
shown with quilted back option



LSZE26 Zenda
High Back 2 Seater Sofa
with Wings
shown with quilted back & button option

Berkeley

Stylish, modern, ergonomic high back winged armchair designed by Jon Crawford, suited for multi-environment use including nursing, healthcare and residential environments, with mental health specification options for challenging environments.

Standard Features

- Extremely robust, durable easy chair
- High back winged styling
- Fixed waterfall seat cushion
- Contoured, posture supportive back with lumbar support



LSBE01 Berkeley
Wingback Armchair
Fixed Seat



LSBE21 Berkeley
Wingback Armchair
Removable Seat

Optional Features

- Piping
- Quilted stitch back
- Quilted back stitch & buttons
- Comfort seat
- Reflexion® pressure relief seat foam
- Wood finish options (see page 33)
- Customise from a wide range of fabrics to enhance any space (see pages 30-31)

Jasper

Complements the Teal soft seating ranges, developed for use in care home, nursing home and residential environments.



SSJA01 Jasper
Footstool

Standard Features

- Fully upholstered
- Button detail

Optional Features

- Customise from a wide range of fabrics to enhance any space (see pages 30-31)



**A collection of modular seating options.
Ideal for socialising and interaction in staff
areas, reception, lounge and quiet spaces.**



Durable and resistant to abrasion, a range of stain resistant, waterproof and anti-microbial contract fabrics are available, including vinyl/faux leather and fabric upholstery options.

Modular+ Sofas



Multiple vinyl / fabric upholstery options & colours available
see pages 30-31 for further information

See page 321-322 for
product dimensions

Linx



A modular, highly configurable range with soft appearance and feel, characterised by sumptuous levels of comfort. Ideal for all areas including staff areas, lounge, quiet spaces, and reception areas.



LNX1 Linx
Seat Unit
600w



LNX2 Linx
Seat Unit
900w



LNX3 Linx
Seat Unit
1200w



LNX4 Linx
2.5 Seat Unit
1500w



LNX5 Linx
3 Seat Unit
1800w



LNX6 Linx
Corner Seat Unit



LNX7 Linx
Base Unit
600w



LNX9 Linx
Coffee Table
900sq

LNX8 Linx
Base Unit
900w

Standard Features

- Modular design offers an infinite number of configurations
- Creates a truly flexible space, ideal for socialising and interaction
- Solid Beech inset glides

Unit Options

- Mid back seating units (600, 900, 1200, 1500, 1800 width options)
- Corner seat unit
- Base unit (600 & 900 width options)
- Co-ordinating coffee table (900sq)
- Arm options

Optional Features

- Units can be linked together
- Bariatric chair options
- Air piping option creates a defined seam that leads the eye with ease around the sofa profile
- Wood finish options (see page 33) with Medicote™ anti-bacterial lacquer
- Customise from a wide range of fabrics to enhance any space (see pages 30-31)

Piping



Standard



Air piping option



Seat Unit with arms

Coffee Table Top Finish Options



Linx creates a truly flexible space, ideal for socialising and interaction in a variety of settings.

Maldive Modular



Create an informal and contemporary space for socialising and relaxation with Maldive. Comprising of individual pieces, Maldive is a modular system available with a choice of cushions, leg styles and arm options.

Upholstery Options

- Removable seat & back
- Fixed seat & removable back
- Fixed seat & zip fixed back
- Fixed seat & fixed back (excluding corner units)

Optional Features

- Wood finish options (see page 33) with Medicote™ anti-bacterial lacquer
- Customise from a wide range of fabrics to enhance any space (see pages 30-31)

Maldive configurations require a site survey to confirm configuration & access.

Arm Options

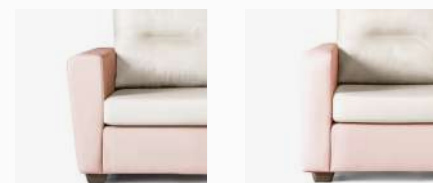

Round arm

Tapered arm

Leg Options



Block foot

Glide foot



SSML-1A Maldive
Single Unit Chair
Right hand arm



SSML-1 Maldive
Single Unit Chair



SSML-A1 Maldive
Single Unit Chair
Left hand arm



SSML-C Maldive
Corner unit

Et'Cetera

The Et'Cetera soft seating collection is designed to provide a simple, effective solution for contemporary waiting and reception areas.



T1000R Et'Cetera
Modular Right Armchair



T1000L Et'Cetera
Modular Left Armchair



T1000 Et'Cetera
Modular Chair

Standard Features

- Plastic glides
- Customise from a wide range of fabrics to enhance any space



Mote

Mote features contemporary styling with minimalist aesthetic for larger reception and atrium areas



MTE-SF01 Mote
Single Sofa



MTE-SF02 Mote
2 Seater Sofa

Standard Features

- Contemporary styling with minimalist aesthetic
- Ideal for larger reception and atrium areas
- 90 Degree and 120 degree corner modules available
- Traditional carcass construction with multi density foam
- Fully upholstered
- Cast Aluminium frame
- Customise from a wide range of fabrics and wood finishes to enhance any space



Soltaire



Soltaire TSS007X shown with arm option and TSS004X coffee table.

Soltaire lends itself to a variety of settings, offering the dual benefit of comfort and durability. A modular solution that can be configured to create a variety of layouts in staff, reception and atrium spaces.

Features

- Extremely robust, durable seating range with fixed seat and back
- Solid wood glides for ease of manoeuvrability

Options

- Arm option
- Coffee table option
- Wood finish options (see page 33) with Medicote™ anti-bacterial lacquer
- Customise from a wide range of fabrics to enhance any space (see pages 30-31)



TSS001X Soltaire
Single Chair



TSS002X Soltaire
2 Seater Sofa



TSS003X Soltaire
3 Seater Sofa



TSS004X Soltaire
Coffee Table



TSS005X Soltaire
Single chair / Corner / Single Chair
(Shown with arm option)



TSS006X Soltaire
2 Seater Sofa / Corner / Single Chair
(Shown with arm option)



TSS007X Soltaire
Single chair / Corner / 2 Seater Sofa
(Shown with arm option)



TSS008X Soltaire
2 Seater sofa / Corner / 2 Seater Sofa
(Shown with arm option)

Soltaire creates a truly flexible space, ideal for socialising and interaction in a variety of settings.

Coffee Table Top & Glide Finish Options



Perfectly at home in any interior space our tub and utility chairs adapt effortlessly to any environment, with contemporary and classic designs offering endless possibilities.



Fawley TSFA01 Tub Chair shown with F11 Coffee Table with Shorewood top.



Multiple vinyl / fabric upholstery options & colours available
see pages 30-31 for further information

See page 322-323 for
product dimensions

Tub+ Utility Seating

Suki



Suki, with a focus on comfort and modern styling is perfectly at home in a variety of settings. With supportive back and stylish fixed waterfall seat cushion Suki ensures no compromise on aesthetics.

Standard Features

- Fixed waterfall seat
- Stylish block feet

Optional Features

- Piping
- Skid Legs
- Plus+ one piece cover, fully sealed to prevent concealment and aid cleaning*
- Wood finish options (see page 33)
- Customise from a wide range of fabrics to enhance any space (see pages 30-31)



TSSU01 Suki
Tub Chair



TSSU03 Suki
2 Seater Sofa

*Only available on selected fabrics & vinyl's with strengthened seams





Felicity



A beautiful show wood frame highlights the form and shape of Felicity. Compact and stylish Felicity adapts effortlessly to any environment.

Standard Features

- Contemporary styling
- Show wood frame
- Curved profile
- Double piping finishing detail
- Fixed seat



LSFE01 Felicity
Armchair

Optional Features

- Wood finish options (see page 33)
- Customise from a wide range of fabrics to enhance any space (see pages 30-31)

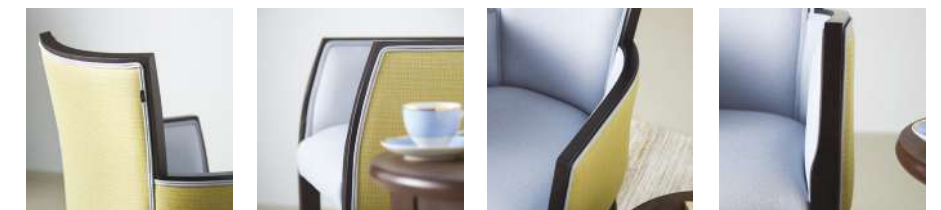



Fawley

Fawley is a timeless addition to any space. With its gently curved silhouette this stylish tub chair is perfectly at home in a bedroom, lounge or reception space.

Standard Features

- Softly rounded back for support and comfort
- Compact footprint
- Removable seat
- Integrated show wood legs

Optional Features

- Piping
- Comfort Foam
- Wood finish options (see page 33)
- Customise from a wide range of fabrics to enhance any space (see pages 30-31)



Fawley TSFA01 shown with F11 Coffee Table with Shorewood top.



TSFA01 Fawley Tub Chair



TSFA02 Fawley 2 Seater Sofa



Choose a contrast seat colour to add a stylish accent on a tub or two-seater Fawley.



Valentino



Compact and stylish, Valentino is at home in any location; easy to move around it offers a flexible seating option and brings a touch of glamour to any room.

Standard Features

- Comfortable fixed waterfall seat
- Elegant integrated tapered leg

Optional Features

- Piping
- Buttons
- Wood finish options (see page 33)
- Customise from a wide range of fabrics to enhance any space (see pages 30-31)

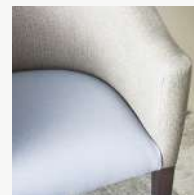

TSVA01 Valentino
Tub Chair



TSVA02 Valentino
2 Seater Sofa



Meridian



Meridian has a presence in any room, for multi-environment use in bedroom, lounge, corridor or reception areas. Choose a contrast seat colour to add a stylish accent.

Standard Features

- Contemporary, robust and versatile tub chair
- Fixed seat cushion

Optional Features

- Wood finish options (see page 33)
- Customise from a wide range of fabrics to enhance any space (see pages 30-31)



TSME01X Meridian
Tub Chair



TSME02X Meridian
2 Seater Sofa



Pixie



A stylish occasional chair at home in a lounge, dining room, bedroom, activity room or corridor. Developed for multi-environment use in healthcare.

Standard Features

- Upholstered occasional chair
- Curved back shape
- Integrated solid wood legs

Optional Features

- Piping
- Fluted back
- Diamond stitch back & buttons
- Wood finish options (see page 33)
- Customise from a wide range of fabrics to enhance any space (see pages 30-31)



DCPI01 Pixie
Mid Back Side Chair



DCPI02 Pixie
Mid Back Armchair



DCPI03 Pixie
High Back Side Chair



DCPI04 Pixie
High Back Armchair



Thatcher



With low, mid and posture supportive high back or curved back options Thatcher is a truly versatile, multi-purpose seating collection. Easy rise arms assist with sit-to-stand movement.

Standard Features

- Robust, durable and beautifully finished solid beech frame
- Smooth rounded corners with no sharp edges
- Curved back with comfortable deep foam fixed seat cushion

Optional Features

- Wood finish options (see page 33)
- Customise from a wide range of fabrics to enhance any space (see pages 30-31)



T2023 Thatcher
Low Back, High Seat
Armchair



T2012 Thatcher
Mid Back
Armchair



T2013 Thatcher
High Back, High Seat
Armchair



T1011CUR Thatcher
Low Back Side Chair
with Curved Back



T1012CUR Thatcher
Low Back Armchair
with Curved Back

Roku®



Designed to bring a contemporary look to any space, Roku® is available fully upholstered, non-upholstered, with seat and back pad options and with a matching table.

Standard Features

- Ergonomically designed back and armrest provide excellent support and levels of comfort
- Wipe clean surfaces for infection control
- Non-upholstered Roku® suitable for indoor and outdoor use
- Upholstered model available in a range of contract vinyls & fabrics (see pages 30-31)



TSRK23 Roku®
Tub Chair
Fully Upholstered



TSRK22 Roku®
Moulded Tub Chair
Upholstered Seat Pad



TARK21 Roku®
Moulded Table

TSRK21 Roku®
Moulded Tub Chair
Non-upholstered

TSRK24 Roku®
Bench Seat
Fully Upholstered

TSRK25 Roku®
Moulded Tub Chair
Upholstered Seat & Back Pad

Finishes

Iron Gate	Cornflower Blue	Heather Purple
Warm Sand	Sage Green	Misty Blue
Slate Green	Chateau Grey	Fresh Papaya
Marine Teal	Roku® Renu	Granite

Create beautiful spaces with our dining and café collections. Contemporary and classic designs available in a wide selection of fabrics and finishes.



Zenda DCZE01 Dining Chair shown with F Leg Dining Table with White top.



Multiple vinyl / fabric upholstery options & colours available see pages 30-31 for further information

See pages 323-324 for product dimensions

Dining+ Café Chairs

Zenda



Zenda adapts effortlessly to its environment – either in a dining space, corridor or casual seating area. Blending striking solid beech legs with modern full arm design Zenda delivers on both style and practicality.



DCZE01
Armchair

Standard Features

- Full armed dining chair
- Secured back cushion
- Stylish, tapered legs
- Solid beech legs

Optional Features

- Fluted back option adds a stylish accent
- Wood finish options (see page 33) with Medicote™ anti-bacterial lacquer
- Customise from a wide range of fabrics to enhance any space (see pages 30-31)



Henley

Versatile Henley is great as dining or activity / visitor chair, or as a dressing table chair in the bedroom.



DCHE01
Stacking
Open Tub Chair

Standard Features

- Stacking upholstered tub chair with open sides
- Open sides mean that food does not get trapped down the side of the chair
- Easy grip arms assist to a standing position
- Stylish beech frame

Optional Features

- Wood finish options (see page 33) with Medicote™ anti-bacterial lacquer
- Customise from a wide range of fabrics to enhance any space (see pages 30-31)



Adriatic



Adriatic offers ageless style in any dining room. Crafted with a choice of beech slatted back, or upholstered seat and back options to enhance any space.



S334 Adriatic
Side Chair
with Slatted Back



S335 Adriatic
Armchair
with Slatted Back



S336 Adriatic
Side Chair
with Upholstered Back



S337 Adriatic
Armchair
with Upholstered Back

Standard Features

- Solid beech frame, mortise and tenon construction for added strength

Optional Features

- Solid beech skid leg option to aid movement
- Wood finish options (see page 33) with Medicote™ anti-bacterial lacquer
- Customise from a wide range of fabrics to enhance any space (see pages 30-31)

Waldorf



Waldorf DCWA02 dining armchair with skid legs as standard

With its elegant, upholstered back and beautiful beech frame Waldorf creates a stylish, timeless aesthetic in any dining space.

Standard Features

- Solid beech frame, mortise and tenon construction for added strength

Optional Features

- Solid beech skid leg option to aid movement
- Wood finish options (see page 33) with Medicote™ anti-bacterial lacquer
- Customise from a wide range of fabrics to enhance any space (see pages 30-31)



DCWA01 Waldorf
Armchair



DCWA03 Waldorf
Side Chair

DCWA02 Waldorf
Armchair
with Skid Legs (shown)

DCWA04 Waldorf
Side Chair
with Skid Legs

Avenue



Avenue DCAV02 armchair shown with F Leg table



Characterised by its contemporary show wood frame, Avenue complements any dining or activity space.



DCAV01 Avenue Side Chair



DCAV02 Avenue Armchair



DCAV08 Avenue Side Chair with Braced Skid Legs



DCAV09 Avenue Armchair with Braced Skid Legs

Standard Features

- Solid beech frame, mortise and tenon construction for added strength

Optional Features

- Solid beech skid leg option to aid movement
- Wood finish options (see page 33) with Medicote™ anti-bacterial lacquer
- Customise from a wide range of fabrics to enhance any space (see pages 30-31)

Anne



Simple yet stylish stacking chair with supportive deep back to ensure optimum posture, suitable for dining and activity spaces.



C501-1 Anne
Side Chair

C503-1 Anne
Armchair

Standard Features

- Stacking chair (5 high)
- Hygiene / sacral gap
- Upholstered seat pad and seat back

Optional Features

- Wood finish options (see page 33) with Medicote™ anti-bacterial lacquer
- Customise from a wide range of fabrics to enhance any space (see pages 30-31)



Charlotte



Charlotte offers an alternatively styled back to the Anne range. With stylish beech frame and stacking capability, Charlotte is a versatile choice for dining and activity spaces.



C500-1 Charlotte
Side Chair

C502-1 Charlotte
Armchair

Standard Features

- Stacking chair (5 high)
- Hygiene / sacral gap
- Upholstered seat pad and seat back

Optional Features

- Wood finish options (see page 33) with Medicote™ anti-bacterial lacquer
- Customise from a wide range of fabrics to enhance any space (see pages 30-31)



Kasumi



Kasumi brings a touch of class to any dining space. Choose from a selection of fabrics to bring Kasumi to life, or a fluted back to add a stylish accent.



DCKA01
Side Chair
Fully Upholstered
Seat & Back



DCKA02
Armchair
Fully Upholstered
Seat & Back



DCKA05
Side Chair
Fully Upholstered
with Sacral Gap



DCKA06
Armchair
Fully Upholstered
with Sacral Gap

Standard Features

- Lumbar support
- Comfort foam as standard
- Seat depth and height enable ease of manoeuvrability
- No hidden crevices or seams for easy cleaning procedure

Optional Features

- Fluted back option adds a stylish accent
- Solid beech ski leg option to aid movement
- Wood finish options (see page 33) with Medicote™ anti-bacterial lacquer
- Customise from a wide range of fabrics to enhance any space (see pages 30-31)



Kurva

Kurva brings a sense of elegance to any dining room, with side chair, armchair and high back dining armchair options to suit every preference.



DCKU01 Kurva
Side Chair



DCKU02 Kurva
Armchair



DCKU03 Kurva
High Back
Armchair

Standard Features

- Solid beech frame, mortise and tenon construction for added strength

Optional Features

- Solid beech skid leg option to aid movement
- Wood finish options (see page 33) with Medicote™ anti-bacterial lacquer
- Customise from a wide range of fabrics to enhance any space (see pages 30-31)



Kurva chairs shown with F leg dining table

Darcey



With its show wood frame Darcey blends style with comfort. Skid leg option available to aid movement, with easy rise arms to assist with sit-to-stand movement.

Zinnia



Add modern elegance to your dining space with our fabulous Zinnia collection. Available with or without sacral gap and with matching high stool option.



DCDA01 Darcey
Side Chair



DCDA02 Darcey
Armchair

Standard Features

- Solid beech frame, mortise and tenon construction for added strength

Optional Features

- Solid beech skid leg option to aid movement
- Wood finish options (see page 33) with Medicote™ anti-bacterial lacquer
- Customise from a wide range of fabrics to enhance any space (see pages 30-31)



DCZI01 Zinnia
Side Chair



DCZI02 Zinnia
Side Chair
with Sacral Gap



DCZI03 Zinnia
Armchair



DCZI04 Zinnia
Armchair
with Sacral Gap

Standard Features

- Integrated solid beech frame for added strength with stylish tapered conical leg design

Optional Features

- Wood finish options (see page 33) with Medicote™ anti-bacterial lacquer
- Customise from a wide range of fabrics to enhance any space (see pages 30-31)



DCZI05 Zinnia
Upholstered High Stool



DCZI06 Zinnia
Upholstered High Stool
with Sacral Gap

Pixie



Pixie DCPI01 & DCPI02 shown with 714 Style dining table

A stylish occasional chair at home in a lounge, dining room, bedroom, activity room or corridor. Developed for multi-environment use in nursing homes, care homes and residential environments.



DCPI01 Pixie
Mid Back
Side Chair



DCPI02 Pixie
Mid Back
Armchair



DCPI03 Pixie
High Back
Side Chair



DCPI04 Pixie
High Back
Armchair

Standard Features

- Upholstered occasional chair
- Curved back shape for added comfort
- Integrated solid beech legs for added strength

Optional Features

- Piping
- Fluted back
- Diamond stitch back with buttons
- Wood finish options (see page 33) with Medicote™ anti-bacterial lacquer
- Customise from a wide range of fabrics to enhance any space (see pages 30-31)

Ophelia



Ophelia DCOP01 shown with 714 Style dining table

Ophelia is a beautiful accent chair with stylish silhouette. Perfect for any high-end interior, Ophelia completes the look in a dining, bedroom or casual seating space.



DCOP01 Ophelia
Dining, Lounge
& Occasional Armchair

Standard Features

- Ergonomic comfort back and gently tapered arms

Optional Features

- Wood finish options (see page 33) with Medicote™ anti-bacterial lacquer
- Customise from a wide range of fabrics to enhance any space (see pages 30-31)



Arlo



Arlo is a stylish and simple range of multi-purpose stacking chairs. Considering the need for both functionality and style the colourful chairs are ideal for working spaces and sociable places.

Ikon



Ikon is a well designed, multi-purpose chair family with modern aesthetic and stacking capability.



ARL10 Arlo
Stacking Side chair



ARL10A Arlo
Stacking Armchair



ARL20 Arlo
Stacking Side Chair,
Skid Frame



ARL30 Arlo
Stackable High Stool,
4 Leg Frame

ARL11
Stacking Side Chair
with Seat Pad

ARL11A
Stacking Armchair
with Seat Pad

ARL21 Arlo
Stacking Armchair, Skid
Frame with Seat Pad

ARL31 Arlo
Stackable High Stool,
4 Leg Frame with Seat Pad

Metal Frame Finishes



Shell Finishes

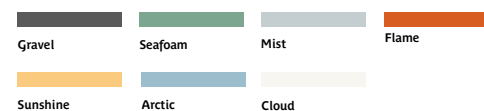

Standard Features

- Moulded shell available in seven colours
- Tubular steel frame
- Plastic glides
- Stackable
- Underseat stacking shroud

Optional Features

- Linking
- Mobile trolley



DCIK01 Ikon
Side Chair
with Upholstered Seat
& Plastic Back



DCIK02 Ikon
Armchair
with Upholstered Seat
& Plastic Back



DCIK03 Ikon
Side Chair
with Upholstered Seat
& Back



DCIK04 Ikon
Armchair
with Upholstered Seat
& Back

Metal Frame Finishes



Standard Features

- High grade, trilliptical steel tube creates a modern aesthetic
- Visually inviting, anatomically moulded seat, back and armrest
- Stacks up to 5 high

Optional Features

- Customise from a wide range of fabrics to enhance any space (see pages 30-31)

Our versatile, lightweight chairs provide a flexible solution in a wide variety of healthcare settings. With stacking capability, model options are available with wipe clean upholstery or polyurethane finish options.



Core stacking armchairs shown with and without arms in Brick, Grey and White.

Stacking+ Chairs



Multiple vinyl / fabric upholstery options & colours available
see pages 30-31 for further information

See page 325 or
product dimensions

Core



Core combines simple, timeless modern design with long lasting durability. Suitable for waiting and outpatient areas, training rooms, conference or meeting spaces.

Standard Features

- Stacks 5 high
- Steel 4 Leg frame available in Black as standard (Grey, White, Brick or Polished Chrome options)
- Multiple model options, including plastic back and seat, plastic back and upholstered seat, upholstered back and seat
- Arms available in Black Plastic as standard

Optional Features

- Armchair linking device
- Side chair linking device
- Stacking chair trolley
- Writing tablet
- Under seat basket
- Leg finish options available
- Customise from a wide range of fabrics to enhance any space



Side Linking Device
An innovative connection plug for linking armless chairs.

At the centre of its design is the blend of durable components and versatile accessories. Offering a robust and functional solution that doesn't compromise on style.



CRE1 Core
Side Chair
Plastic Back, Plastic Seat



CRE2 Core
Side Chair
Plastic Back, Upholstered Seat



CRE3 Core
Side Chair
Upholstered Back, Upholstered Seat



CRE1A Core
Armchair
Plastic Back, Plastic Seat



CRE2A Core
Armchair
Plastic Back, Upholstered Seat



CRE3A Core
Armchair
Upholstered Back, Upholstered Seat

Arms

The arm pad boasts a unique feature: it pivots freely, offering an extra 50mm of space when positioned outward, granting users added comfort and flexibility. When set upright, it enables Core chairs equipped with arms and writing tablets to be neatly stacked.

Finish Options

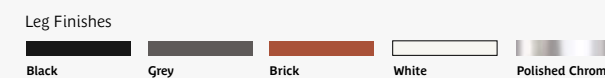
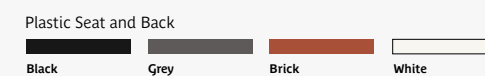

Arm Finishes

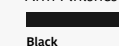

Arlo

Arlo is a stylish and simple range of multi-purpose stacking chairs.



ARL10 Arlo
Stacking Side Chair

ARL11
Stacking Side Chair with Seat Pad



ARL20 Arlo
Stackable High Chair, Skid Frame

ARL21 Arlo
Stacking Armchair, Skid Frame with Seat Pad



ARL10A Arlo
Stacking Armchair

ARL11A
Stacking Armchair with Seat Pad



ARL30 Arlo
Stackable High Stool, 4 Leg Frame

ARL31 Arlo
Stackable High Stool, 4 Leg Frame with Seat Pad

Standard Features

- Moulded shell available in seven colours
- Tubular steel frame
- Glides
- Stackable
- Underseat stacking shroud

Optional Features

- Linking
- Mobile trolley

Metal Frame Finishes



Shell Finishes

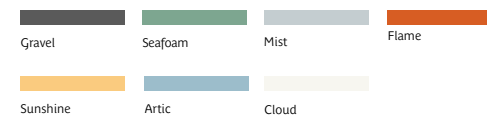

Vox

Stylishly designed, multi-purpose economic stacking visitor chair with contemporary aesthetic.



Slim, shaped supportive back and no visible fixings for infection management.

PSVX01 Vox
Contemporary Side Chair

Finishes



Tonina

Tonina is a stylish, flexible and compact stacking chair inspired by shapes in nature, designed exclusively by Claudio Dondoli.



RSTN01 Tonina
Side Chair



RSTN03 Tonina
Side Chair with Seat Pad, Seat Pad available in a wide range of fabrics



RSTN02 Tonina
Armchair

RSTN04 Tonina
Armchair with Seat Pad

Standard Features

- UV colour resistance
- Stacks up to 6 high

Finishes

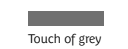

Firenza

Firenza stacking chair, suitable for high traffic public spaces.



T88 Firenza
Side Chair



T89 Firenza
Armchair with Black PU Arms

Standard Features

- Upholstered seat and back
- Robust tubular steel frame
- Stacks up to 5 high

Metal Frame Finishes



Ikon

Well designed, highly tooled dining or multi-purpose seating range with stacking capability.



DCIK03 Ikon
Side Chair with Upholstered Seat & Back



DCIK04 Ikon
Armchair with Upholstered Seat & Back

Standard Features

- Stacks up to 5 high
- Stacking armchair with upholstered seat and back
- High grade, trilliptical steel tube creates a modern aesthetic
- Visually inviting, anatomically moulded seat, back and armrest

Frame Finishes



Other models available see page 235

Anne

A deep backed and robust multi-purpose healthcare chair for visitor, dining and activity areas.



C501-1 Anne
Side Chair



C503-1 Anne
Armchair



Standard Features

- Stacking chair (5 high)
- Hygiene / sacral gap
- Upholstered seat pad and seat back

Optional Features

- Wood finish options (see page 33) with Medicote™ anti-bacterial lacquer
- Customise from a wide range of fabrics to enhance any space (see pages 30-31)

Charlotte

Charlotte is a robust multi-purpose healthcare chair for visitor, dining and activity areas.



Standard Features

- Stacking chair (5 high)
- Hygiene / sacral gap
- Upholstered seat pad and seat back

Optional Features

- Wood finish options (see page 33) with Medicote™ anti-bacterial lacquer
- Customise from a wide range of fabrics to enhance any space (see pages 30-31)



C500-1 Charlotte
Side Chair



C502-1 Charlotte
Armchair

[Back to contents](#)

Luca



RSLU01 Luca
Armchair

Luca multi-environment stacking polyurethane armchair.

Standard Features

- Stacks 5 high
- Tough, durable polyurethane utility chair
- Wipe clean for infection control
- UV colour resistance
-

Finishes



Grey

Breeze



DCBR01 Breeze
Children's Stacking Chair
6 size options available

Breeze children's stacking chairs are designed to promote good posture and provide exceptional comfort.

Finishes



Other finish options available on request

Standard Features

- Stacks 12 high
- Durable, stain resistant and 100% recyclable
- Can be upholstered for added comfort
- Safe, stable design

Optional Features

- Seat Height options:
260, 310, 350, 380, 430, 460mm

Zola

Lightweight, durable, high density stacking chairs, suitable for indoor or outdoor use.

Finish Options



DCZL01 Zola
Side Chair



DCZL02 Zola
Armchair



Standard Features

- Stacks up to 6 high
- Polypropylene with glass fibre
- Compact legs gas injected
- UV colour resistance
- Suitable for indoor and outdoor use

A great addition to any dining or lounge space, our contemporary range of dining table options includes pedestal base and height adjustable options for wheelchair users. With coffee table options in a range of stylish finishes to suit any interior.



Tevo Dining Table shown with White Oak top

Dining+ Coffee Tables

Dining Tables



F Style Dining Table shown with White finish top & contrast Shorewood legs, Anne C501-1 Dining Side Chair with Anne C503-1 Dining Armchair.

Smart, simple dining tables with a choice of styles and leg shapes.



714 Style

Traditional underframe, available in square, rectangular and circular sizes shown below

H: 790
(710 to underside of rail)



F Style

Tapered leg, available in square, rectangular and circular sizes shown below

H: 760

Standard Features

- Soft, radiused corners for added safety
- Easy clean, scratch and heat resistant 25mm laminate top
- Wheelchair friendly heights
- Choice of leg shapes and underframe options
- Square, rectangular and circular top style options in a variety of sizes
- Bullnose safety edges with Medicote™ anti-bacterial lacquer

Options

- Laminate top options
- Wood finish options

Leg Styles



714 Style



F Style



Size options:

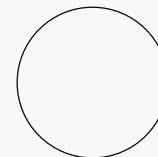

Circular

Dia: 600
Dia: 675
Dia: 750
Dia: 900
Dia: 1075
Dia: 1200

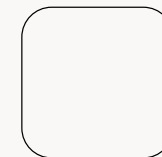

Square

W: 600 D: 600
W: 750 D: 750
W: 900 D: 900
W: 1075 D: 1075
W: 1200 D: 1200



Rectangular

W: 1200 D: 600
W: 1200 D: 900
W: 1500 D: 750
W: 1500 D: 900
W: 1800 D: 750
W: 1800 D: 900

All measurements in mm

Wood Finish Options

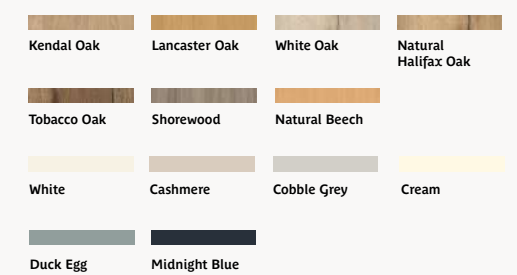

Dining & coffee tables

Arch



T66-6RD Arch
Round Dining Table
Dia: 600

T66-7RD Arch
Round Dining Table
Dia: 750

T66-9RD Arch
Round Dining Table
Dia: 900

H: 760

T67



T67/6RD
Round Dining Table
Dia: 600

T67/7RD
Round Dining Table
Dia: 750

T67/9RD
Round Dining Table
Dia: 900

H: 762

Waldorf



TAWA01 Waldorf
Round Dining Table
Dia: 1060

TAWA03 Waldorf
Oval Dining Table
1920 x 1200w

TAWA04 Waldorf
Oval Double Pedestal Dining Table
Diameter: 2400 x 1200w

H: 740

Evoked Dining



TAEV02 Evoked
Dining Table

H: 745
Dia: 900

Evoked Coffee



TAEV01 Evoked
Coffee Table

H: 410
Dia: 750

T60



T60-6SQ Pedestal Table
with Stained Wood Column
W: 600 D: 600

T60-7SQ - W: 750 D: 750

H: 760

Logan Height Adjustable

Designed for wheelchair users Logan height adjustable tables rise from **750** to **1115** to ensure ease of access and correct seating height.



Logan Round
Height Adjustable Table

TALO900RD
Dia: 900

TALO1075RD
Dia: 1075



Logan Square
Height Adjustable Table

TALO900SQ
900x900

With a highly durable, scratch and heat resistant laminate surface for use in high traffic dining spaces.

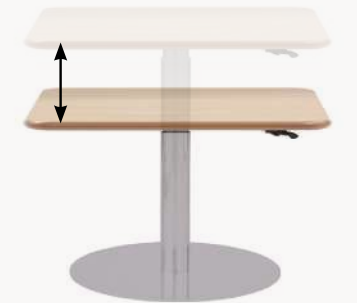

Standard Features

- Height Adjustable
- Gas spring powered
- Plastic paddle / handle to underside of top to activate height adjustment
- Adjustment can stop anywhere within the 750 to 1115mm range by releasing the paddle / handle
- Easy clean, scratch and heat resistant 25mm Laminate Top with bullnose safety edge
- Standard Grey base finish

Top Size Options

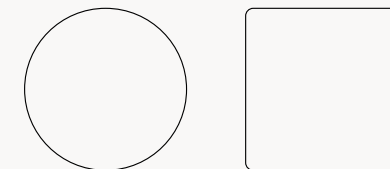

Circular

Dia: 900
Dia: 1075

Square

W: 900 D: 900

H: 750 - 1115

All measurements in mm

Wood Finish Options

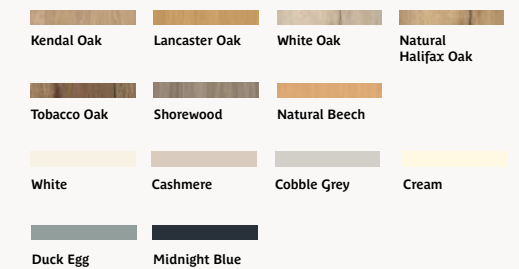

Tevo



A beautifully presented yet simple table collection with a slim, neat central column. Tevo adds the finishing touch in a multitude of environments. Available in black, brushed steel, brass, or brass and black combinations.

Wood Finish Options



Column & Base Finish



Standard Features

- Soft, radiused corners for added safety
- Easy clean, scratch and heat resistant 25mm laminate top with tough bullnose edging

Optional Features

- Coffee table, dining table or poseur table options
- Wide choice of sizes and table top finish options



TCTE-600RD
Round Coffee Table
600 Laminate Top

TCTE-750RD - Dia: 750

H: 455



TCTE-600SQ
Square Coffee Table
600 x 600 Laminate Top

TCTE-750SQ - W: 750 D: 750

H: 455



TPTE-600RD
Round Poseur Table
600 Laminate Top

TPTE-750RD - Dia: 750

Square Poseur Table
TPTE-600SQ - W: 600 D: 600

H: 1100



TDTE-600RD
Round Dining Table
600 Laminate Top

TDTE-750RD - Dia: 750
TDTE-900RD - Dia: 900
TDTE-1075RD - Dia: 1075
TDTE-1200RD - Dia: 1200

H: 745



TDTE-600SQ
Square Dining Table
600 x 600 Laminate Top

TDTE-750SQ - W: 750 D: 750
TDTE-900SQ - W: 900 D: 900
TDTE-1075SQ - W: 1075 D: 1075

H: 745



TDTE-1200/600 - Rectangular
Double Pedestal Dining Table
1200 x 600 Laminate Top

TDTE-1200/900 - W: 1200 D: 900
TDTE-1500/750 - W: 1500 D: 750
TDTE-1500/900 - W: 1500 D: 900
TDTE-1800/750 - W: 1800 D: 750
TDTE-1800/900 - W: 1800 D: 900

H: 745

All measurements in mm

Coffee Tables Top Shape Options

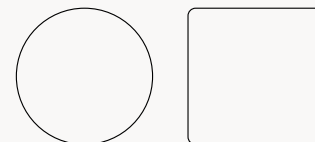

Dining Tables Top Shape Options

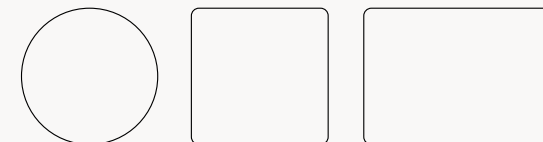

Poseur Tables Top Shape Options

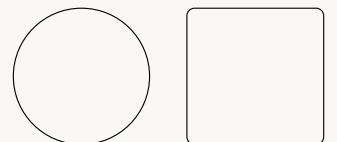

Asterix



Asterix is the ideal accompaniment to any contemporary interior, with a perfect blend of quality and stability. Add personality by pairing the black or brushed steel base with an eye-catching contrast finish.

Wood Finish Options



Column & Base Finish



Standard Features

- Soft, radiused corners for added safety
- Easy clean, scratch and heat resistant 25mm laminate top with tough bullnose edging

Optional Features

- Coffee table, dining table or poseur table options
- Wide choice of sizes and table top finish options



TCAS-600RD
Round Coffee Table
600 Laminate Top

TCAS-750RD - Dia: 750
H: 455



TCAS-600SQ
Square Coffee Table
600 x 600 Laminate Top

TCAS-750SQ - W: 750 D: 750
H: 455



TPAS-600RD
Round Poseur Table
600 Laminate Top

TPAS-750RD - Dia: 750
Square Poseur Table
TPAS-600SQ - W: 600 D: 600
H: 1100



TDAS-600RD
Round Dining Table
600 Laminate Top

TDAS-750RD - Dia: 750
TDAS-900RD - Dia: 900
TDAS-1075RD - Dia: 1075
TDAS-1200RD - Dia: 1200

H: 745



TDAS-600SQ
Square Dining Table
600 x 600 Laminate Top

TDAS-750SQ - W: 750 D: 750
TDAS-900SQ - W: 900 D: 900
TDAS-1075SQ - W: 1075 D: 1075

H: 745



TDAS-1200/600 - Rectangular
Double Pedestal Dining Table
1200 x 600 Laminate Top

TDAS-1200/900 - W: 1200 D: 900
TDAS-1500/750 - W: 1500 D: 750
TDAS-1500/900 - W: 1500 D: 900
TDAS-1800/750 - W: 1800 D: 750
TDAS-1800/900 - W: 1800 D: 900

H: 745

All measurements in mm

Coffee Tables Top Shape Options

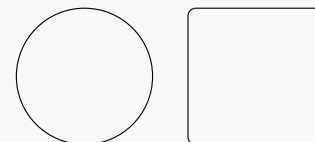

Dining Tables Top Shape Options



Poseur Tables Top Shape Options

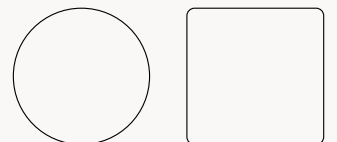

Bexley



Bexley opens up a wide range of possibilities, full of adaptability and versatility. The classic trumpet base offers a seamless balance between style and practicality. Available in a range of sizes with black or brushed steel base.

Wood Finish Options

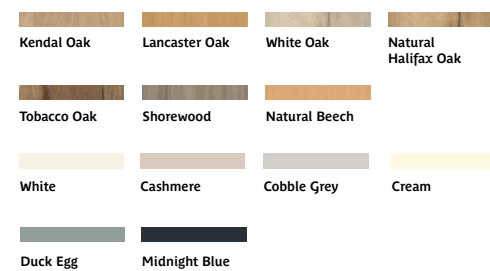

Column & Base Finish



Standard Features

- Soft, radiused corners for added safety
- Easy clean, scratch and heat resistant 25mm laminate top with tough bullnose edging

Optional Features

- Coffee table, dining table or poseur table options
- Wide choice of sizes and table top finish options



TCBE-600RD
Round Coffee Table
600 Laminate Top
TCBE-750RD - Dia: 750
H: 455



TCBE-600SQ
Square Coffee Table
600 x 600 Laminate Top
TCBE-750SQ - W: 750 D: 750
H: 455



TPBE-600RD
Round Poseur Table
600 Laminate Top
TPBE-750RD - Dia: 750
Square Poseur Table
TPBE-600SQ - W: 600 D: 600
H: 1100



TDBE-600RD
Round Dining Table
600 Laminate Top
TDBE-750RD - Dia: 750
TDBE-900RD - Dia: 900
TDBE-1075RD - Dia: 1075
TDBE-1200RD - Dia: 1200
H: 745



TDBE-600SQ
Square Dining Table
600 x 600 Laminate Top
TDBE-750SQ - W: 750 D: 750
TDBE-900SQ - W: 900 D: 900
TDBE-1075SQ - W: 1075 D: 1075
H: 745



TDBE-1200/600 - Rectangular
Double Pedestal Dining Table
1200 x 600 Laminate Top
TDBE-1200/900 - W: 1200 D: 900
TDBE-1500/750 - W: 1500 D: 750
TDBE-1500/900 - W: 1500 D: 900
TDBE-1800/750 - W: 1800 D: 750
TDBE-1800/900 - W: 1800 D: 900
H: 745

All measurements in mm

Coffee Tables Top Shape Options

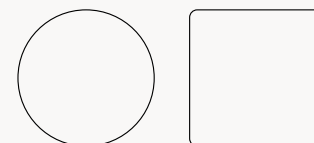

Dining Tables Top Shape Options



Poseur Tables Top Shape Options

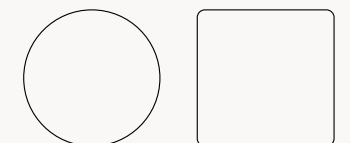

Albany



Albany creates a perfect silhouette with its stylish tailored base, ideal for creating a relaxed, sociable dining space. Dining table and poseur base options available with black base.

Wood Finish Options



Column & Base Finish



Standard Features

- Soft, radiused corners for added safety
- Easy clean, scratch and heat resistant 25mm laminate top with tough bullnose edging

Optional Features

- Dining table or poseur table options
- Wide choice of sizes and table top finish options



TDAL-600RD
Round Dining Table
600 Laminate Top

TDAL-750RD - Dia: 750
TDAL-900RD - Dia: 900
TDAL-1075RD - Dia: 1075
TDAL-1200RD - Dia: 1200

H: 745



TDAL-600SQ
Square Dining Table
600 x 600 Laminate Top

TDAL-750SQ - W: 750 D: 750
TDAL-900SQ - W: 900 D: 900
TDAL-1075SQ - W: 1075 D: 1075

H: 745



TPAL-600RD
Round Poseur Table
600 Laminate Top

TPAL-750RD - Dia: 750

H: 1100



TPAL-600SQ
Square Poseur Table
600 x 600 Laminate Top

TPAL-750SQ - W: 750 D: 750

H: 1100

Create a contemporary interior by using pedestal dining tables that look great in a modern dining or bistro setting.

All measurements in mm

Dining Tables Top Shape Options

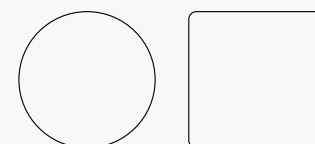

Poseur Tables Top Shape Options

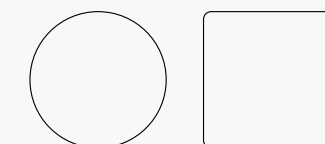

Kilda



Create a contemporary interior by using Kilda pedestal tables, that not only look great, but are equally at home in a modern dining space, café, bistro or bar setting. Available in a range of sizes, column & base finishes.

Wood Finish Options

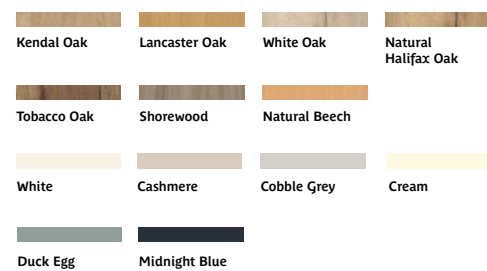

Column & Base Finish



Standard Features

- Soft, radiused corners for added safety
- Easy clean, scratch and heat resistant 25mm laminate top with tough bullnose edging

Optional Features

- Dining table or poseur table options
- Wide choice of sizes and table top finish options



TDKI-750RD
Round Dining Table
750mm; Laminate Top

TDKI-600RD - Dia: 600
TDKI-900RD - Dia: 900
TDKI-1075RD - Dia: 1075
TDKI-1200RD - Dia: 1200

H: 745



TDKI-750SQ
Square Dining Table
750x750mm; Laminate Top

TDKI-600SQ - W: 600 D: 600
TDKI-900SQ - W: 900 D: 900
TDKI-1075SQ - W: 1075 D: 1075

H: 745



TDKI-1200/900
Rectangular Double
Pedestal Dining Table
1200x900; Laminate Top

TDKI-1200/600 - W: 1200 D: 600
TDKI-1500/750 - W: 1500 D: 750
TDKI-1500/900 - W: 1500 D: 900
TDKI-1800/750 - W: 1800 D: 750
TDKI-1800/900 - W: 1800 D: 900

H: 745



TPKI-750RD
Round Poseur Table
750mm; Laminate Top

TPKI-600RD - Dia: 600

Square Poseur Table
TPKI-750SQ - W: 750 D: 750
TPKI-600SQ - W: 600 D: 600

H: 1100

All measurements in mm

Dining Tables Top Shape Options

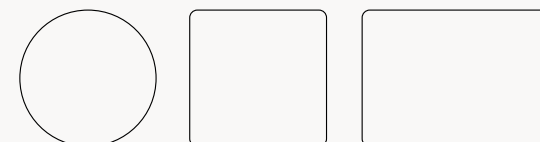

Poseur Tables Top Shape Options

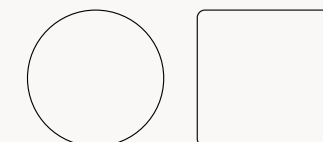

Clara



Clara's wide range of tables compliment the Arlo Seating range, allowing the tables to suit meeting, dining and breakout areas.



Round top

CLR08RD - 800 Dia
CLR12RD - 1200 Dia
CLR15RD - 1500 Dia
Height - 740

Square top

CLR08SQ - W: 800 D: 800
CLR12SQ - W: 1200 D: 1200
CLR16SQ - W: 1600 D: 1600
Height - 740

Rectangle top

CLR1408RC - W: 1400 D: 800
CLR1810RC - W: 1800 D: 1000
Height - 740

Standard Features

- MFC tops in a range of top shapes including, Round, Square and Rectangular
- Solid Ash legs

Options

- Choice of finish options

All measurements in mm

MFC Table Top Finish Options



Solid Ash Leg Finishes



Axyl



Axyl is a sophisticated table collection that combines stylish, minimal aesthetic with highly durable elements. With its cast aluminium base, Axyl is exceptionally robust. Designed for continued use in high traffic dining spaces.



Round top

AXLD08RD - Dia: 800
AXLD09RD - Dia: 900
Height - 740

Square top

AXLD07SQ - W: 750 D: 750
Height - 740

Rectangle top

AXLR1609 - W: 1600 D: 900
AXLR2009 - W: 2000 D: 900
Height - 740

Standard Features

- 25mm Laminate (Edge 38) faced MDF core top with a clear finish edge
- Cast Aluminium base and Aluminium column
- Plastic glides with levelling adjustment

Options

- Available in a selection of powder coat finishes
- Table edge profile can be stained in a selection of finishes

All measurements in mm

Table Top Finish Options



Metal Frame Finishes

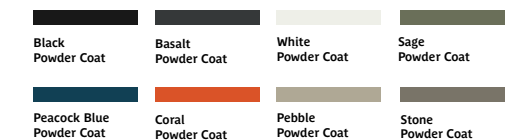

Moxi



Comfort and style converge with Moxi's soft seating and table range. A seamless blend of functionality, creativity, and strength, tailored to enhance collaborative environments while prioritising individual comfort and productivity.

Standard Features

- 25mm MFC Top
- Tubular Steel frame finished in Black or Silver Powder Coat

MFC Top Finishes

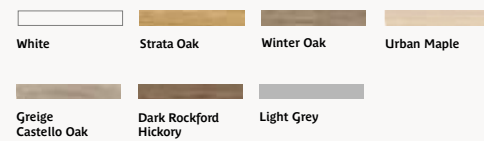

Frame Finishes

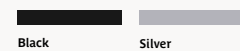

Stylish Moxi is available with a choice of coffee tables, dining & high table options.



MXST
Square Coffee Table

H: 330 W: 640 D: 640



MXCT
Rectangular Coffee Table

H: 330 W: 1300 D: 640



MXDT
Rectangular Dining Table

H: 725 W: 1300 D: 640



MXHT
Rectangular High Table

H: 1050 W: 1300 D: 640



All measurements in mm

Coffee Tables



Designed for versatility our coffee tables are a popular choice in an array of environments, with clean, simple lines and a wide choice of finish options.

Standard Features

- Soft, radiused corners for added safety
- Easy clean, scratch and heat resistant 25mm laminate top
- Bullnose safety edges with Medicote™ anti-bacterial lacquer
- Solid beech legs

Options

- Laminate top options
- Wood finish options

Wood Finish Options

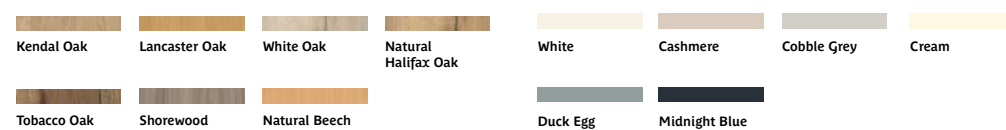

B Style



B Style Coffee Table
With tapered leg

B07
Circular

Dia: 455 / 610 / 915
H: 405/510

711 Style



711 Coffee Table
Square with straight leg (shown)

711W Coffee Table
Square with straight leg & lower shelf

W: 660 **D:** 610
H: 405/510

F11 Style



F11-450RD Coffee Table
Circular with tapered leg and traditional underframe

Dia: 455 **H:** 510

B Style



B Style Coffee Table
With tapered leg

B08 rectangular (shown)
W: 1075 **D:** 600

B06 Square
W: 610 **D:** 610

H: 405/455/510
(**H:** 455 in **B06** only)

712 Style



712 Coffee Table
Rectangular with straight leg

712W Coffee Table
Rectangular with straight leg & lower shelf

W: 1170 **D:** 610
H: 405/510

714C Style



714C Coffee table
Circular with straight leg

Dia: 610 **H:** 405/510

T15 Style



T15-600X300
With tapered leg
H: 520 **W:** 600 **D:** 300

Nesting Tables



NT1 Nest of tables
H:510 **W:**550 **D:**395

Evoke



TAEV01 Evoke
Coffee Table
Dia: 750 **H:** 410

All measurements shown in mm.

Durham



TADU01 Durham
Round Occasional Table
Solid Wood Top
H: 500 Dia: 600mm



TADU02 Durham
Round Occasional Table
Solid Wood Top
H: 600 Dia: 450mm



TADU03 Durham
Oval Occasional Table
Solid Wood Top
W: 1100 D: 600 H: 500



TADU04 Durham
Half Round Hall Table
Solid Wood Top
W: 1000 D: 400 H: 750

All measurements in mm

Sonata



TASO02
Round Occasional Table

TASO01 Sonata
Round Occasional Table
Solid Wood Top
H: 550 Dia: 600mm

TASO02 Sonata
Round Occasional Table
Solid Wood Top
H: 550 Dia: 800

TASO03 Sonata
Oval Occasional Table
Solid Wood Top
W: 1100 D: 600 H: 550

TASO04 Sonata
Half Round Hall Table
Solid Wood Top
W: 1400 D: 450 H: 750

TASO05 Sonata
Round Dining Table
Solid Wood Top
H: 750 Dia: 1200

TASO06 Sonata
Square Occasional Table
Solid Wood Top
W: 450 D: 450 H: 550

TASO07 Sonata
Square Occasional Table
Solid Wood Top
W: 600 D: 600 H: 550

TASO08 Sonata
Rectangular Occasional Table
Solid Wood Top
W: 750 D: 450 H: 550

Beaumont



TABE01
Round Side Table
Solid Wood Top
Dia: 600 H:550



TABE03
Rectangular Coffee Table
Solid Wood Top
W: 1000 D: 600 H:550



TABE04
Square Side Table
Solid Wood Top
W: 600 D: 600 H: 550

Wood Finish Options

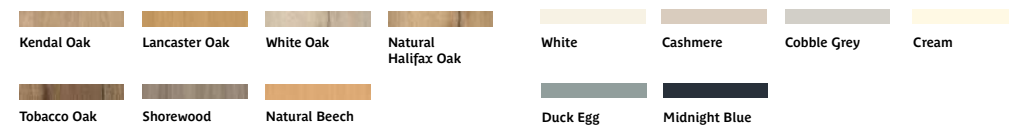

Herbie



Herbie's range of low level tables beautifully compliment the Herbie soft seating collection in reception and breakout areas. Solid Ash legs can be stained in Oak or Black to compliment the Herbie soft seating collection.



HRBCT06RD
Round Table
W: 600 D: 600 H: 520



HRBCT06SQ
Square Table
W: 600 D: 600 H:520



HRBCT07RD
Round Table
W: 700 D: 700 H: 520



HRBCT07SQ
Square Table
W: 700 D: 700 H: 520



HRBCT07SS
Soft Square Table
W: 700 D: 700 H: 520



HRBCT1007SR
Soft Rectangle Table
W: 1000 D: 700 H:520

Standard Features

- MFC top
- Solid Ash 4 leg frame

MFC Top Finishes



Frame finishes



Portobello Stools & Coffee Tables



Suitable for a range of settings, Portobello is a multi-use collection of fully upholstered stools and coffee tables.

Portobello Stools



SSPO01X
Hexagonal Stool

W: 515
D: 580
H: 495



SSPO02X
Cylinder Stool

Dia: 470
H: 510



SSPO03X
Soft Square Stool

W: 470
D: 470
H: 510



SSPO04X
Rectangular Bench Stool

W: 1030
D: 530
H: 510

Standard Features

- Tables feature easy clean, scratch and heat resistant tops
- Soft radiused corners for added safety
- Medicote™ anti-bacterial lacquer
- White Nylon feet allow easy repositioning
- Vinyl wrapped top in either KYDEX® or standard finishes

Optional Features

- Wood finish options

Portobello Coffee Tables

Portobello coffee tables are available in a variety of heights and shapes – round, soft square, hexagonal and rectangular to suit room layout.



TAPO04X
Circular Coffee Table

Base Dia: 700
H: 460



TAPO05X
Square Coffee Table

W: 700
D: 700
H: 460



TAPO06X
Hexagonal Coffee Table

W: 515
D: 580
H: 495



TAPO07X
Hexagonal Coffee Table

W: 515
D: 580
H: 650



TAPO08X
Cylinder Coffee Table

Dia: 470
H: 475



TAPO09X
Cylinder Coffee Table

Dia: 470
H: 650



TAPO10X
Soft Square Coffee Table

W: 470
D: 470
H: 475



TAPO11X
Soft Square Coffee Table

W: 470
D: 470
H: 650



TAPO12X
Rectangular Coffee Table

W: 1030
D: 530
H: 475

Wood Finish Options



KYDEX® Top Colour Options:



Sunda 1

This range of plectrum shaped occasional tables offers a variety of sizes and heights which can be clustered to create a unique shape. These simple yet elegant tables are manufactured from laser cut sheet Steel



SUN101
Low Level Table

W: 510
D: 525
H: 375



SUN102
Low Level Table

W: 425
D: 485
H: 405



SUN103
Low Level Table

W: 460
D: 550
H: 345

Sunda 2



SUN201
Low Level Table

Dia:1000
H: 285



SUN202
Low Level Table

Dia: 800
H: 315



SUN203
Low Level Table

Dia:600
H: 345



SUN204
Low Level Table

Dia: 400
H: 375

Mainline Metal Finishes



Veneers & Laminates



These beautiful occasional tables are available in various heights and diameters that can be nestled together to create a stunning multilevel centre piece. The table tops are finished in a reformed Oak veneer that can be clear lacquered or stained, with Steel tripod frame.

Standard Features

- Reformed Oak veneer face tops on 25mm MDF with a cutback, clear finish edge profile
- Tripod tubular steel frame



Conic



A636-5555 Conic
Soft square coffee table

W:540
D: 540
H: 405

Other size options available.

Wire Frame Finishes

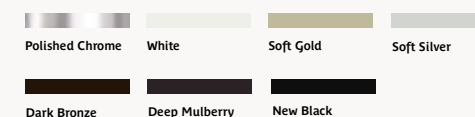

Laminate Options

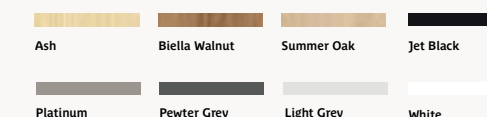

X&Y

X&Y tables are smart, functional, height adjustable pull up tables which feature an easy push lift system for height adjustment.

Standard Features

- 25mm MFC top with matching edge tape
- Easy lift frame finished in black or white powder coat
- Levelling Glides
- Docking cradle for battery
- Rechargeable battery 200 w/hrs
- Battery charging station for 3 no. batteries

Optional Features

- Lockable Castors



MFC Table Top Finish Options

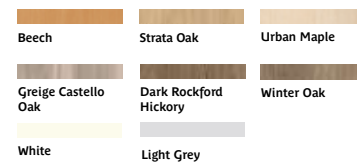

Frame Finishes



More finish options available on request.



XY01
Small soft rectangle, height adjustable

H: 545 - 795
W: 550 **D:** 350

Other size options available.



XY02
Small soft square, height adjustable

H: 545 - 795
W: 550 **D:** 500

Host



Host is a standalone table for use as a laptop support or work surface and is proportioned accordingly, with a weighted stable base and elegant column.

A convenient hand grip to the underside of the edge together with side slides under the base plate allows the user to easily glide the table closer.

Standard Features

- Aluminium table construction
- Teflon glides



HLT2
Soft square occasional

W: 350
H: 600

Metal Finishes

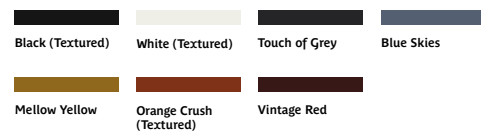

Talon

Talon is a stunning collection of versatile occasional tables designed to accompany soft seating in lounge or breakout areas.

Standard Features

- Laminate faced top, 25mm MDF core with clear lacquered edge detail
- Tubular Steel column finished in Black powder coat*
- Polished Aluminium base*
- Teflon glides for easy movement

Optional Features

- Table edge profile can be stained*
- Tubular Steel column available in White, Slate Grey or Bronze powder coat*



TAL21SST
Small Soft Triangle

H: 440
W: 500 **D:** 500



TAL21LST
Large Soft Triangle

H: 440
W: 950 **D:** 950

MFC Table Top Finish Options



Metal Finishes



More finish options available on request.



Our wide range of stylish, contemporary storage solutions help to create a beautifully functional space. Select from wood finishes or painted finishes to enhance your space.

Lounge+ Cabinets

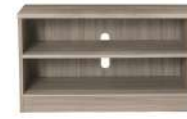

LCRE03 Regent
TV unit

W: 910 **D:** 480 **H:** 525



LCRE04 Regent
TV unit with
2 doors

W: 910 **D:** 480 **H:** 836



LCRE05 Regent
Open TV unit with
3 shelves & 4 drawers

W: 1400 **D:** 480 **H:** 600



LCRE06 Regent
Sideboard with
2 doors & 2 drawers

W: 910 **D:** 480 **H:** 836



LCRE07 Regent
Sideboard with
1 door & 4 drawers

W: 910 **D:** 480 **H:** 836



LCRE08 Regent
Sideboard with
2 doors & 4 drawers

W: 1358 **D:** 480 **H:** 836



LCRE12 Regent
Sideboard with
3 doors

W: 1358 **D:** 480 **H:** 836



LCRE09 Regent
Bookshelf
with 4 shelves

W: 910 **D:** 355 **H:** 1250



LCRE11 Regent
Display Unit
with 4 shelves & 1 drawer

W: 910 **D:** 480 **H:** 1800

LCRE10 Regent
Bookshelf
with 5 shelves

W: 910 **D:** 480 **H:** 1800



Ordering:

To order the lounge furniture range required, insert the appropriate product code (shown right).

The Regent range order codes **(RE)** are shown with the images above.

Ranges:

- RE** - Regent
- KW** - Kingsway

Optional Features

- Customise from a wide range of wood finishes (see page 33)

Additional ranges available.
See www.teal.co.uk for details.

A wide range of lounge storage and display options; including console tables, ladderback storage, display tables, sideboards, bookcases and rummage storage drawers - perfect for care and residential environments.

Panama

Panama is a high end range of complimentary, solid oak cabinet pieces.

Standard Features

- Solid oak
- Stylish groove detailing

Optional Features

- Customise from a wide range of wood finishes (see page 33)



LCPN01
Sideboard Unit
LHF Door, RHF 4 Drawers

W: 1090 D: 500 H: 850



LCPN02
Sideboard Unit
2 Doors

W: 1090 D: 500 H: 850



LCPN03 Panama
Sideboard Unit; LHF Door,
Central 4 Drawers, RHF Door

W: 1600 D: 500 H: 850



LCPN04
Sideboard Unit
LHF Door, Central Open 3
Shelves, RHF Door

W: 1600 D: 500 H: 850



LCPN05
Chest of Drawers
4 Drawers

W: 1000 D: 500 H: 1000



LCPN06
Chest of Drawers
LHF 4 Drawers, RHF 4 Drawers

W: 1090 D: 500 H: 850



LCPN07
Side Table
Upper Drawer,
Open Lower

W: 500 D: 450 H: 660



LCPN08
Console Table
1 Upper Drawer

W: 790 D: 380 H: 740



LCPN09 Panama
Console Table
2 Upper Drawers

W: 1150 D: 475 H: 780



LCPN10
Bookshelf Unit
5 Open Shelves Over
1 Lower Drawer

W: 850 D: 320 H: 1875



Panama is a high end range of complimentary, solid oak cabinet pieces.

Lounge furniture items



LCCR01 Credenza
Display Table W: 1200

LCCR02 Credenza
Display Table W: 1600

D: 400 H: 800



TADU04 Durham
Console Table

D: 400 H: 800



TAST01
Console Table W: 1200

TAST02
Console Table W: 1500

D: 560 H: 760



LCRU01 Rummage
Chest of Drawers;
3 Drawers Over 3 Drawers Over
2 Drawers Over 2 Drawers

W: 1040 D: 520 H: 826

Hampton

The beautiful Hampton natural oak range adds a touch of luxury and sophistication, helping to create a warm and welcoming space.

Standard Features

- Modern design
- Half Moon table can be positioned adjacent to wall or sofa

Optional Features

- Key Lock (Top drawer & cupboard door)
- Customise from a wide range of wood finishes (see page 33)



LCHM01
Half Moon
Half moon end table

W: 700 D: 400 H: 550



LCHP01
Sideboard Unit
2 Drawers Over 2 Doors

W: 890 D: 440 H: 860



LCHP02
Sideboard Unit
3 Drawers Over 3 Doors

W: 1295 D: 440 H: 860



LCHP03
Sideboard Unit
LHF Door, Central 4 Drawers,
RHF Door

W: 1295 D: 440 H: 860



LCHP04
Dresser Unit
2 Drawers Over 2 Door Lower
Section with Two Door Over
Open Shelf Upper Section

W: 890 D: 440 H: 1830



LCHP05
Dresser Unit
3 Drawers Over 3 Door Lower
Section with Three Door Over
Open Shelf Upper Section

W: 1295 D: 440 H: 1830

Hampton natural oak range with solid oak frame and real oak veneer panels.

[Back to contents](#)

Lounge + Cabinets



LCHP06
TV Unit, 2 Door
Over 1 Drawer

W: 930 D: 440 H: 610



LCHP07
TV Unit, 2 Door
Over 1 Drawer

W: 1200 D: 440 H: 610



LCHP08
TV Unit, LHF Upper Door,
Central Upper 2 Shelves,
RHF Upper Door Over 2 Drawers

W: 1500 D: 440 H: 610



LCHP09
Bookshelf Unit
3 Shelves

W: 970 D: 310 H: 1075



LCHP10
Bookshelf Unit
5 Shelves

W: 850 D: 310 H: 1840



LCHP11
Bookshelf Unit
5 Shelves Over
1 Lower Drawer

W: 850 D: 310 H: 1840



LCHP12
Bookshelf Unit
2 Unit Wide, 10 Shelves Over
2 Lower Drawers, Single Top

W: 1700 D: 310 H: 1840

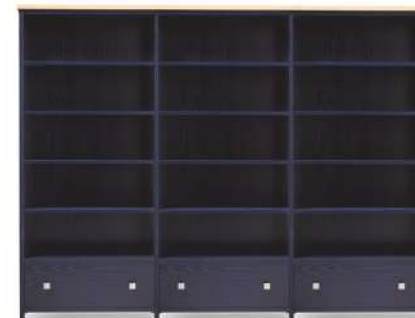

LCHP13
Bookshelf Unit
3 Unit Wide, 15 Shelves Over
3 Lower Drawers, Single Top

W: 2550 D: 310 H: 1840



LCHP14
Display Case
5 Internal Shelves,
Solid Door

W: 535 D: 440 H: 1840



LCHP15
Display Case
5 Internal Shelves,
Glass Fronted Door

W: 535 D: 440 H: 1840



LCHP16
Hall Table
2 Upper Drawers,
Lower Open Shelf

W: 1150 D: 325 H: 740



LCHP17
Hall Table
3 Upper Drawers,
Lower Open Shelf

W: 1150 D: 325 H: 740

Beautiful bedroom furniture is a fundamental element to creating a warm, welcoming space for recuperation, relaxation and sleep.

Teal offer a range of styles: contemporary or traditional, natural wood or painted finishes and a range of flexible configurations that would enhance any bedroom.



As always, an attractive aesthetic is accompanied by focus on ease of access and easy to clean surface materials for effective infection management.

Bedroom+ Furniture



Dawley bedroom range shown with contrast finish top option

Dawley's shaker style and classic panel detail offers a sense of timeless design and charm and is a favourite for bedroom furniture.



CADA12 Dawley
Double Wardrobe



CADA08 Dawley
4 Drawer Chest



CADA32 Dawley
3 Drawer Dressing table



CADA02 Dawley
Bedside Cabinet

Standard Features

- 18mm MFC carcass with 18mm cam and dowelled back
- 2 x 18mm double-step MFC top
- 18mm vinyl wrapped door & drawer fronts for long lasting appearance
- Box drawer construction, drawers with bearing runners
- Stylish matt nickel finished knobs
- 110° fully adjustable soft close hinges
- Full width upper internal shelf
- Full width hanging rail

Optional Features

- Key lock options
- Range of mirrors available with glass or polycarbonate safety glass for added safety
- Internal shelf pack
- Lockable drawers & doors
- Contrast finishes available

Fitted installation available to include:

- Skirting cutout, wall securing options

Dawley

Available in a range of colours with contrasting wood top (option), Dawley offers minimal ornamentation in line with the traditional styling and a high end domestic look.

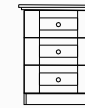

OH: 590
OW: 460
OD: 480

CADA01
Bedside Unit
3 Drawers

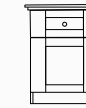

OH: 590
OW: 460
OD: 480

CADA02
Bedside Unit
Upper Drawer
Lower Door

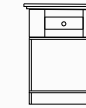

OH: 590
OW: 460
OD: 480

CADA03
Bedside Unit
Upper Drawer
Open Lower

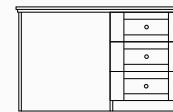

OH: 765
OW: 1210
OD: 580

CADA32
Dressing Table
3 Drawer Pedestal

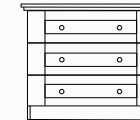

OH: 660
OW: 810
OD: 480

CADA07
Chest of Drawers
3 Drawers

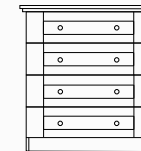

OH: 845
OW: 810
OD: 480

CADA08
Chest of Drawers
4 Drawers



OH: 1815
OW: 610
OD: 610

CADA10
Single Wardrobe

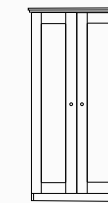

OH: 1815
OW: 760
OD: 610

CADA11
Double Wardrobe

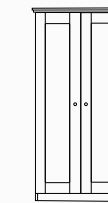

OH: 1815
OW: 910
OD: 610

CADA12
Double Wardrobe



Regent bedroom range shown with contrast finish top option

Contemporary, minimal styling details and innovative scoop handles distinguish the Regent Range as perfect for care and residential environments.



CARE12 Regent
Double Wardrobe



CARE07 Regent
3 Drawer Chest



CARE06 Regent
Dressing Table



CARE02 Regent
Bedside Cabinet

Standard Features

- Integrated scoop aluminium handles
- 18mm MFC carcass
- 18mm cam and dowelled back
- 22mm vinyl wrapped soft edge tops
- 18mm vinyl wrapped matching door and drawer fronts for long lasting appearance and with detailed styling
- Four sided drawer box with easy clean white metal sides
- 110° fully adjustable soft close hinges
- Full width upper internal shelf
- Full width hanging rail

Optional Features

- Range of mirrors available with glass or polycarbonate safety glass for added safety
- Internal shelf pack
- Lockable drawers & doors
- Contrast finishes available
- Soft close drawer runners

Fitted installation available to include:

- Skirting cutout, wall securing options

Regent

A wide range of unit configurations available to create a beautifully functional space. Select from wood effects or painted finishes to enhance your space.



OH: 575
OW: 460
OD: 480

CARE01
Bedside Unit
3 Drawers

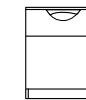

OH: 575
OW: 460
OD: 480

CARE02
Bedside Unit
Upper Drawer
Lower Door

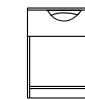

OH: 575
OW: 460
OD: 480

CARE03
Bedside Unit
Upper Drawer
Open Lower

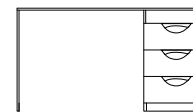

OH: 750
OW: 1210
OD: 580

CARE06
Dressing Table
3 Drawer Pedestal
with Magazine Shelf

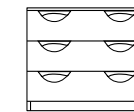

OH: 650
OW: 810
OD: 480

CARE07
Chest of Drawers
3 Drawers

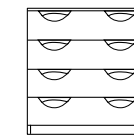

OH: 830
OW: 810
OD: 480

CARE08
Chest of Drawers
4 Drawers

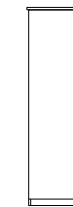

OH: 1800
OW: 610
OD: 610

CARE10
Single Wardrobe
Single Door

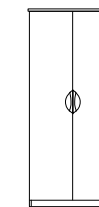

OH: 1800
OW: 760
OD: 610

CARE11
Double Wardrobe
Double Door

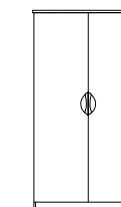

OH: 1800
OW: 910
OD: 610

CARE12
Double Wardrobe
Double Door



Wellington

A wide range of unit configurations creates a beautifully functional space, whilst a large selection of wood and painted finishes help to customise and enhance the space.

Wellington exhibits the clean, sleek lines of contemporary design without compromising on a warm and welcoming environment.



CAWE12 Wellington
Double Wardrobe



CAWE08 Wellington
4 Drawer Chest



CAWE32 Wellington
Dressing Table



CAWE02 Wellington
Bedside Cabinet

Standard Features

- Stylish bar handles
- 18mm MFC carcass
- 18mm cam and dowelled back for added strength
- 22mm vinyl wrapped soft edge tops
- 18mm vinyl wrapped matching door and drawer fronts for long lasting appearance and with detailed styling
- Four sided drawer box with easy clean white metal sides
- 110° fully adjustable soft close hinges
- Full width upper internal shelf
- Full width hanging rail

Optional Features

- Range of mirrors available with glass or polycarbonate safety glass for added safety
- Internal shelf pack
- Lockable drawers & doors
- Contrast finishes available
- Soft close drawer runners

Fitted installation available to include:

- Skirting cutout, wall securing options

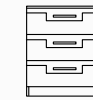

OH: 575
OW: 460
OD: 480

CAWE01
Bedside Unit
3 Drawers

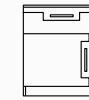

OH: 575
OW: 460
OD: 480

CAWE02
Bedside Unit
Upper Drawer
Lower Door

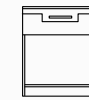

OH: 575
OW: 460
OD: 480

CAWE03
Bedside Unit
Upper Drawer
Open Lower

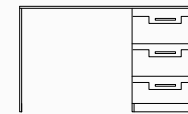

OH: 750
OW: 1210
OD: 580

CAWE32
Dressing Table
3 Drawer Pedestal

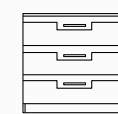

OH: 650
OW: 810
OD: 480

CAWE07
Chest of Drawers
3 Drawers

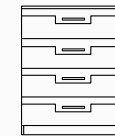

OH: 830
OW: 810
OD: 480

CAWE08
Chest of Drawers
4 Drawers

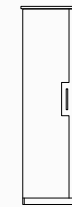

OH: 1800
OW: 610
OD: 610

CAWE10
Single Wardrobe
Single Door

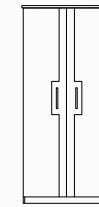

OH: 1800
OW: 760
OD: 610

CAWE11
Double Wardrobe
Double Door

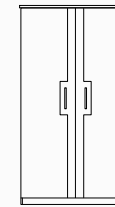

OH: 1800
OW: 910
OD: 610

CAWE12
Double Wardrobe
Double Door

Kingsway

Select from a wide range of wood effects or painted finishes and flexible unit configurations.



Kingsway bedroom range shown with Zenda LSZE03 mid back armchair

The Kingsway range, with stylish bow handles, is available in a wide range of attractive wood or painted finishes to create a modern, minimal, yet comfortable and homely aesthetic for any space.



CAKW12 Kingsway
Double Wardrobe



CAKW07 Kingsway
3 Drawer Chest



CAKW06 Kingsway
Dressing Table



CAKW02 Kingsway
Bedside Cabinet



OH: 575
OW: 460
OD: 480

CAKW01
Bedside Unit
3 Drawers



OH: 575
OW: 460
OD: 480

CAKW02
Bedside Unit
Upper Drawer
Lower Door



OH: 575
OW: 460
OD: 480

CAKW03
Bedside Unit
Upper Drawer
Open Lower

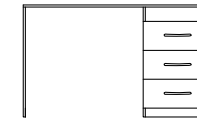

OH: 750
OW: 1200
OD: 630

CAKW06
Dressing Table
3 Drawer Pedestal
with Magazine Shelf



OH: 650
OW: 810
OD: 480

CAKW07
Chest of Drawers
3 Drawers



OH: 835
OW: 810
OD: 480

CAKW08
Chest of Drawers
4 Drawers

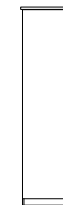

OH: 1810
OW: 600
OD: 610

CAKW10
Single Wardrobe
Single Door

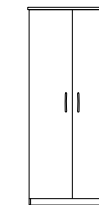

OH: 1800
OW: 750
OD: 610

CAKW11
Double Wardrobe
Double Door

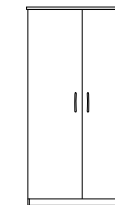

OH: 1800
OW: 900
OD: 610

CAKW12
Double Wardrobe
Double Door

Standard Features

- Stylish bow handles
- 18mm MFC carcass
- 18mm cam and dowelled back for added strength
- 25mm MFC top with 2mm edged PVC lipping
- 18mm MFC drawer fronts with 2mm PVC edge
- Four sided drawer box with easy clean white metal sides
- 110° fully adjustable soft close hinges
- Full width upper internal shelf
- Full width hanging rail

Optional Features

- Range of mirrors available with glass or polycarbonate safety glass for added safety
- Internal shelf pack
- Lockable drawers & doors
- Contrast finishes available
- Soft close drawer runners

Fitted installation available to include:

- Skirting cutout, wall securing options

Province

Select from a wide range of wood effects or painted finishes and cabinet configurations.



Province range shown with **CAPR01** double wardrobe, **CAPR02** Chest 2 over 3 drawers & **CAPR05** Dressing table

Province features clean lines, simplicity and symmetrical cabinetry with recessed panels and smooth, curved edges to create a warm and welcoming, yet modern aesthetic.



CAPR21 Province
Double Wardrobe with
Perspex Insert
on RHF Door



CAPR02 Province
Chest 2 over 3 drawers



CAPR05 Province
Dressing Table



CAPR03 Province
Bedside Cabinet

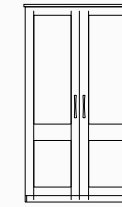

OH: 2000
OW: 1000
OD: 610

CAPR01
Double Wardrobe
Double Doors

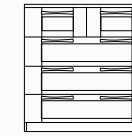

OH: 825
OW: 760
OD: 480

CAPR02
Chest of Drawers
2 Over 3 Drawers

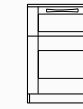

OH: 650
OW: 460
OD: 478

CAPR03
Bedside Unit
Upper Drawer
Lower Door

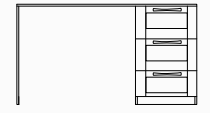

OH: 750
OW: 1210
OD: 580

CAPR05
Dressing Table
3 Drawer Pedestal

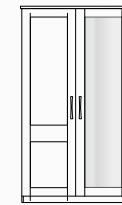

OH: 2000
OW: 1000
OD: 610

CAPR21
Double Wardrobe with
Perspex Insert on
Right Hand Door



OH: 825
OW: 760
OD: 480

CAPR22
Chest of Drawers
2 Over 3 Drawers
with Perspex Inserts
to Upper 2 Drawers

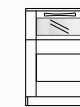

OH: 650
OW: 460
OD: 478

CAPR23
Bedside Cabinet
Upper drawer, Lower Door
with Perspex Insert
to Upper Drawer

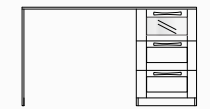

OH: 750
OW: 1210
OD: 580

CAPR25
Dressing Table
3 drawer pedestal
Perspex Insert
to Upper Drawer

Standard Features

- Elegant and contemporary bow handle, with a matt nickel finish
- Integrated wardrobe top boxes
- 18mm MFC carcass
- 18mm cam and dowelled back for added strength
- 22mm vinyl wrapped soft edge tops
- 18mm vinyl wrapped matching door and drawer fronts with detailed styling
- 110° fully adjustable soft close hinges.
- Full width upper internal shelf
- Full width hanging rail

Optional Features

- Bedroom cabinets all have 2 door options:
 - i) Raised shaker style door and drawer detail
 - ii) Dementia friendly perspex door / drawer panels
- Range of mirrors available with glass or polycarbonate safety glass for added safety
- Internal shelf pack
- Lockable drawers & doors
- Contrast finishes available
- Soft close drawer runners

Fitted installation available to include:

- Skirting cutout, wall securing options

Olsen



Olsen BDOL03 shown with FDMAT4 Double 4'6" mattress

Beds+ Mattresses

Olsen is a mesh platform bed providing a stylish overnight solution for hospital key worker or student accommodation.

Standard Features

- Durable epoxy-polyester powder coated bed base easily cleaned for infection control
- Welded 4mm wire mesh base with steel cross supports for added strength
- Tubular steel legs with plastic inserts
- White frame as standard

Optional Features

- Size options: single (3'), small double (4') or double (4'6")
- Mattress options (see page 297)



BDOL01 Olsen
Single 3' Bed



BDOL02 Olsen
Small Double 4' Bed



BDOL03 Olsen
Double 4'6"

Frame colour options:

- White
- Anthracite Grey
- Black

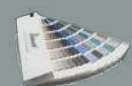

Multiple vinyl / fabric upholstery options & colours available see pages 30-31 for further information

See pages 326-327 for product dimensions

Malta

13.5 guage Bonnell spring unit with 9 guage steel rod edge, flat top finish and Nautilus cover (water resistant, breathable & anti-fungal - inc MRSA).



MABED3
Single 3' Six Legged Bed,
Nautilus Breathable Water Resistant Mattress

MABED5
Small Double 4' Six Legged Bed,
Nautilus Breathable Water Resistant Mattress

MABED4
Double 4'6" Six Legged Bed,
Nautilus Breathable Water Resistant Mattress

Bed bases are manufactured in Scandinavian pine with 6 beech slats and a hard fibreboard top.



(MABED3) Malta single bed supplied with Nautilus mattress shown with optional (BDHB41) Single 3' headboard, plain.

Falkland

13 Guage Bonnell spring unit with 9 guage steel rod edge tufted mattress finished in Keswick Damask.

All sizes available with drawers.



FDBED3 Falkland
Single 3' Divan,
Keswick Damask Mattress

FDBED5 Falkland
Small Double 4' Divan,
Keswick Damask Mattress

FDBED4 Falkland
Double 4'6" Divan,
Keswick Damask Mattress

All Mattresses and bases are flame retardant to BS7177 Medium Hazard I/S 0,1 & 5



(FDBED3) Falkland single supplied with Keswick Damask mattress as standard. Shown with optional (BDHB32) 3' tall headboard quilted.

Guernsey

13.5 Guage Bonnell spring unit with 9 guage steel rod edge, flat top finish and Crosby water resistant PVC cover.



GUBED3
Single 3' Six Legged Bed; PVC Water Resistant Mattress, Castors

GUBED5
Small Double 4' Six Legged Bed; PVC Water Resistant Mattress, Castors

GUBED4
Double 4'6" Six Legged Bed; PVC Water Resistant Mattress, Castors



(GUBED3) Guernsey single bed supplied with Crosby water resistant PVC cover and optional (BDHB41) Single 3' headboard, quilted with buttons.

Skye

Metal mesh base, shown with optional mattress.



SKMBED3 Skye
Single 3' Bed
Skid Legs

SKMBED5 Skye
Small Double 4' Bed,
Skid Legs

SKMBED4 Skye
Double 4'6" Bed,
Skid Legs



(SKMBED3) Skye single bed shown with Standard Mattress (BDSM01) with stitch bond cover. Shown with optional (BDHB31) 3' headboard, buttoned.

Headboards

Bringing contemporary style to any bedroom, Teal headboards are available either bed or wall fixed. Customise from a wide range of fabrics and finishes to enhance any space.

Upholstered Headboards

Choose your upholstery style: plain, horizontal or vertical fluting, buttoned, quilted, or quilted with buttons in any of the width options shown below.

Optional Features

- Bed Fixed or Wall Fixed
- Choose your upholstery style

3' Headboards



BDHB31
Wall Fixed, Single 3' Headboard;
Standard Height
Shown with buttoned option

BDHB41
Bed Fixed, Single 3' Headboard;
Standard Height
Supplied with Headboard Struts



BDHB32
Wall Fixed, Single 3' Headboard;
Tall Height
Shown with quilted option

BDHB42
Bed Fixed, Single 3' Headboard;
Tall Height
Supplied with Headboard Struts

4' Headboards



BDHB33
Wall Fixed, Small Double 4' Headboard;
Standard Height
Shown with quilted with buttons option

BDHB43
Bed Fixed, Small Double 4' Headboard;
Standard Height
Supplied with Headboard Struts



BDHB34
Wall Fixed, Small Double 4' Headboard;
Tall Height
Shown with horizontal fluting option

BDHB44
Bed Fixed, Small Double 4' Headboard;
Tall Height
Supplied with Headboard Struts

4'6" Headboards



BDHB35
Wall Fixed, Double 4'6" Headboard;
Standard Height
Shown with plain upholstery option

BDHB45
Bed Fixed, Double 4'6" Headboard;
Standard Height
Supplied with Headboard Struts



BDHB36
Wall Fixed, Double 4'6" Headboard;
Tall Height
Shown with vertical fluting option

BDHB46
Bed Fixed, Double 4'6" Headboard;
Tall Height
Supplied with Headboard Struts

Wood Headboards

Bed fixed or wall fixed options.

HB1
Single Headboard,
Bed Fixed

HB2
Double Headboard,
Bed Fixed

HB5
Small double Headboard,
Bed Fixed

HB3
Single Headboard,
Wall Fixed

HB4
Double Headboard,
Wall Fixed

HB6
Small double Headboard,
Wall Fixed



Mattresses

Teal offer a range of mattress options including standard models for areas such as student accommodation, a Keswick damask finish, Crosby water resistant PVC cover or the higher specification Nautilus mattress which is water resistant, breathable and anti-fungal.

Standard



BDSM01 Standard
Single 3'0" Mattress
Stitch Bond Cover

BDSM02 Standard
Double 4'6" Mattress
Stitch Bond Cover

PVC Mattress



PVCMAT1 PVC
Single 3'0" Mattress
Crosby Water Resistant PVC Cover

PVCMAT2 PVC
Double 4'6" Mattress
Crosby Water Resistant PVC Cover

PVCMAT3 PVC
Small Double 4' Mattress
Crosby Water Resistant PVC Cover

Nautilus



NMAT1 Nautilus
Single 3'0" Mattress
Water Resistant, Breathable, Anti-Fungal

NMAT2 Nautilus
Double 4'6" Mattress
Water Resistant, Breathable, Anti-Fungal

NMAT3 Nautilus
Small Double 4'
Water Resistant, Breathable, Anti-Fungal

Keswick Damask



FDMAT3
Single 3'0" Mattress
Keswick Damask Mattress

FDMAT5
Small double 4' Mattress
Keswick Damask Mattress

FDMAT4
Double 4'6" Mattress
Keswick Damask Mattress

Mattress Options:

Water resistant, breathable, anti-fungal

Crosby water resistant PVC cover

Keswick Damask

Stitch bond cover



Mattresses and bases are flame retardant to BS7177 Medium Hazard I/S 0,1 & 5

Roku® Roto-moulded Bedroom



Roku® Bedroom is a secure, extremely durable one-piece rotationally moulded bedroom collection designed for challenging environments. Smooth, high impact polyethylene with rounded corners and no sharp edges for safety and durability.

Standard Features

- Smooth, high impact polyethylene, for maximum durability
- Model option with underbed storage area (RKBD02)
- Surface grooves for fluid management and improved cleaning
- Stain-resistant, seamless and easy to clean for infection management
- Mattress retainers to prevent slippage / movement of mattress
- Bed and bedside cabinet sides fit flush to walls
- Single side bed storage can be positioned left or right facing providing flexibility in room layouts
- Smooth, round profile edges ensure enhanced safety and security

Optional Features

- Floor fixing brackets
- Enclosed bottom
- Headboard - KYDEX® headboard
- Colour Finishes

**Secure.
Safe.
Strong.
Durable.**

Smooth, round profile edges ensure enhanced safety and security.



RKBD01 Roku® Bed



RKBD02 Roku® Bed with underbed storage



RKBS01 Roku® Bedside cabinet



RKWU01 Roku® Two shelf wall mount unit



RKWU02 Roku® Three shelf wall mount unit



RKDK01 Roku® Desk



RKCH02 Roku® Kimi Bedroom Chair



RKCH03 Roku® Kimi Bedroom Chair with seat & back pads



RKMT01 C5 Roku® Mattress PU Welded Mattress



RKMT02 C5 Roku® Mattress PU Welded Mattress with Pillow



RKMT03 C5 Roku® Plus Mattress Anti-vandal PVC Mattress



RKMT04 C5 Roku® Plus Mattress Anti-vandal PVC Mattress with Pillow

Finishes

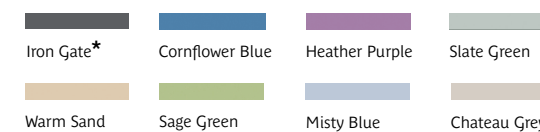

*Iron Gate finish is standard on selected products. Minimum order quantities apply on non-standard colours. MOQ of 5 units per finish ordered.



Suitable for dining and socialising in a variety of healthcare and residential settings our contemporary, durable seating and table ranges can elevate any outdoor space.



See page 328 for product dimensions

Outdoor+ Furniture

Roku®



Designed to bring a contemporary look to any space while being safe and secure Roku® features sealed, anti-ligature, concealment free design for multi-environment use.

Standard Features

- Stain resistant, seamless, easy clean surfaces
- High impact polyethylene continuously moulded for safety and durability
- Soft, radiused corners with no sharp edges for safety and security
- Roku® features durable polyethylene construction with integral UV stabiliser to reduce colour fade in outdoor locations

Optional Features

- Floor fixing options; *With the exception of Roku® Emi
- Weighting options

Finishes

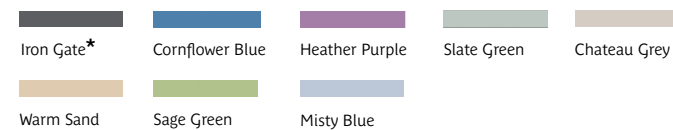

*Iron Gate finish is standard on selected products: Roku® Emi, Roku® Kimi Chairs, Roku® Oyster Tables, Roku® Marna Chairs. Minimum order quantities apply on non-standard colours. MOQ of 5 units per finish ordered.

Additional colour options (selected products only):



All of the 12 colours options shown above are available on Roku® Keata, Roku® Tub, Roku® Table, Button Table & Stool (no MOQ applies).



DCRK01 Roku® Keata
Side Chair



TARK21 Roku®
Table



TSRK27 Roku®
Tub Chair
Outdoor Drain Holes



RKCH01 Roku® Emi
Side Chair
Only available in selected colours
See Roku® finish options



RKCH02 Roku® Kimi
Side Chair
Only available in selected colours
See Roku® finish options



RKTA08 Oyster
900mm Diameter Table
Only available in selected colours
See Roku® finish options



RKMN01 Roku® Marna
Armchair



RKMN03 Roku® Marna
Wide Armchair



RKTA09 Oyster
1100mm Diameter Table
Only available in selected colours
See Roku® finish options

**All items can be floor fixed*
Multiple weighting options available.**



Button



With its compact form, the Button oval table and multi-purpose stool have been designed to exploit the possibilities offered by rotationally moulded plastics, both indoors and outdoors.

Both the Button table and stool can be weighted for added safety and to prevent misuse.



RKBU01 Button
Oval Dining Table



RKBU02 Button
Stool



Finishes



Standard Features

- Smooth, high impact polyethylene, moulded for maximum durability
- Stain-resistant, seamless and easy to clean for longevity and easy maintenance
- Smooth, round profile edges ensure enhanced safety and security

Optional Features

- Teal plastic finishes
- Medium & heavy weighting

Tonina

Tonina is a stylish, flexible and compact stacking chair inspired by shapes in nature, designed exclusively by Claudio Dondoli.

Standard Features

- Injection moulding process to create strength
- UV colour resistance
- Stacks 6 high

Finishes



RSTN01 Tonina
Side Chair



RSTN02 Tonina
Armchair

Luca



RSLU01 Luca
Armchair

Luca multi-environment stacking polyurethane armchair.

Standard Features

- Stacks 5 high
- Tough, durable polyurethane utility chair
- UV colour resistance
- Wipe clean for infection control
- Maximum load 110kg

Finishes



Zola

Lightweight, durable, stacking chairs suitable for indoor or outdoor use.

Finishes



DCZL01 Zola
Side Chair



DCZL02 Zola
Armchair

Standard Features

- Stacks up to 6 high
- Polypropylene with glass fibre
- Compact legs gas injected
- UV colour resistance
- Suitable for indoor and outdoor use



Tibo

With its intelligent use of materials and simple design Tibo helps encourage social interaction between people.

Engineered around a durable, aluminium frame for strength and rigidity Tibo minimises the number of elements at ground level for visual clarity, ease of installation and levelling.



TORD
Round Outdoor
Six Person Table



TOMO
Mid Oblong Outdoor
Eight Person Table



TOLO
Large Oblong Outdoor
Twelve Person Table

Metal Finishes:

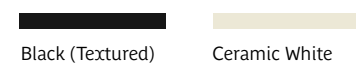

Timber Finish:

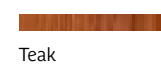

Solid Core Laminate:

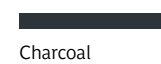

Standard Features

- 18 mm table top and seats in Teak
- Cast aluminium and extruded aluminium frame in Black (textured) or Ceramic White powder coat
- Colour matched stainless steel levelling feet with Nylon pad
- Colour matched floor fixing kit



Crop



Crop is a family of outdoor chairs and stools named after the enigmatic rolling fields of crops in the British countryside, which are represented in the flowing parallel wires of the seating forms.



CRP02 Crop
Armchair
Stack 4 high*



CRP03 Crop
Lounge Chair



CRP05 Crop
High Back Stool

Metal Frame Finishes



Standard Features

- Steel wire frame
- Plastic stacking buffers*
- Plastic glides

Optional Features

- Upholstered seat pad

Crop Seat pads are available in 2 fabric ranges Kvadrat Patio and Agua Aura in select number of colourways.

Axyl Outdoor



Axyl tables are exceptionally robust for continued use in high impact indoor or outdoor dining areas.



Round top
 AXLD08RD-OD - 800 Dia
 AXLD09RD-OD - 900 Dia
 Height - 740



Square top
 AXLD07SQ-OD -W: 750 D: 750
 Height - 740



Rectangle top
 AXLR1609-OD - W: 1600 D: 900
 AXLR2009-OD - W: 2000 D: 900
 Height - 740

A table for every occasion. Axyl café and bistro tables are perfect for smaller gatherings while the dining tables suit larger groups and more formal settings.

Standard Features

- 12mm Solid core laminate top
- Cast Aluminium base and Aluminium centre column
- Plastic glides with levelling adjustment

Options

- Cast Aluminium base and Aluminium centre column available in a selection of powder coat finishes
- Solid core laminate top in Grey or White, with Black edge finish. Cast Aluminium frame available in Black, Ivory, Basalt, or Sage

Laminate Finishes



Edge Finish

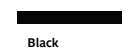

Metal Frame Finishes

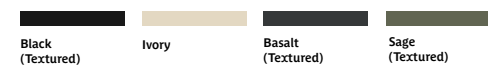

Product Dimensions

OH = Overall Height
OW = Overall Width
OD = Overall Depth
OL = Overall Length
SW = Seat Width

SD = Seat Depth
SH = Seat Height
RS = Removable Seat
FS = Fixed Seat

All measurements in mm

Patient Seating

Apollo Page 50

PSAP02 / PSAP03

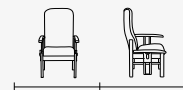

OH: 1195 OD: 735
OW: 635 SD: 470
SW: 510 SH: 480

PSAP04

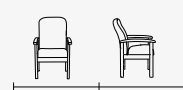

OH: 915 OD: 735
OW: 635 SD: 470
SW: 510 SH: 480

Perry Page 46

730 / 743 / 743N

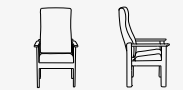

OH: 1205 OD: 735
OW: 635 SD: 470
SW: 510 SH: 480

732

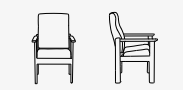

OH: 1010 OD: 735
OW: 635 SD: 470
SW: 510 SH: 480

730W / 730WAI

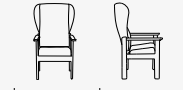

OH: 710 SW: 510
OD: 735 SD: 470
OW: 1205 SH: 480

780



OH: 455 OD: 355
OW: 455

Salus Page 56

PSSA01 / 02

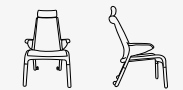

OH: 1190 OD: 830
OW: 655 SD: 495
SW: 535 SH: 460

PSSA03



OH: 320 OD: 500
OW: 440

Velvare Page 54

LSVE01 / LSVE03



OH: 1200 OD: 750
OW: 790 SD: 450
SW: 530 SH: 460

LSVE02



OH: 956 OD: 750
OW: 790 SD: 450
SW: 530 SH: 460

Bariatric Seating

Adeo Page 67

RSAD02-01



OH: 850 OD: 600
OW: 900 SD: 400
SW: 620 SH: 480

RSAD02-02

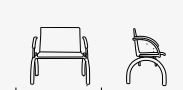

OH: 850 OD: 600
OW: 900 SD: 400
SW: 620 SH: 480

Aylesbury Page 48

830 / 843

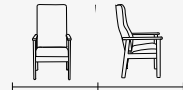

OH: 1205 OD: 660
OW: 470 SD: 470
SW: 470 SH: 480

832

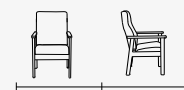

OH: 990 OD: 660
OW: 585 SD: 470
SW: 470 SH: 480

Renaissance Page 52

PSRE01 / 03

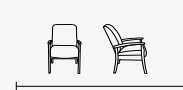

OH: 870 OD: 640
OW: 620 SD: 460
SW: 540 SH: 480

PSRE02 / 04

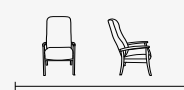

OH: 1190 OD: 640
OW: 620 SD: 460
SW: 540 SH: 480

Tolero Page 38

*PSTL02 / 03
Tolero High Back Chair,
Height Adjustable Legs

OH: 1195-1295

*PSTL05 / 06
Tolero Mid Back Chair,
Height Adjustable Legs

OH: 995 - 1095

PSTL01 / PSTL02*



OH: 1205 OD: 720
OW: 608 SD: 445
SW: 470 SH: 460

PSTL03*

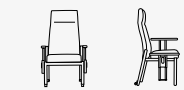

OH: 1195 OD: 720
OW: 640 SD: 445
SW: 470 SH: 460

PSTL04 / 05*

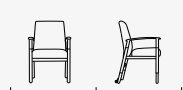

OH: 1005 OD: 720
OW: 608 SD: 445
SW: 470 SH: 460

PSTL06*



OH: 995 OD: 720
OW: 470 SD: 445
SW: 470 SH: 460

PSTL07

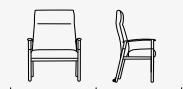

OH: 1205 OD: 720
OW: 845 SD: 445
SW: 700 SH: 460

PSTL08



OH: 1205 OD: 720
OW: 877 SD: 445
SW: 700 SH: 460

Astra Galaxy Page 67

REAG24



OH: 1170 OD: 790
OW: 830 SD: 560
SW: 630 SH: 480 EL: 1740

Back to contents

Astra Page 67

REAS24

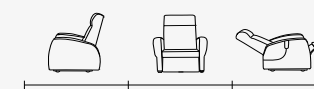

OH: 1180 OD: 900 EL: 1500
OW: 860 SD: 650
SW: 630 SH: 480

REAS25

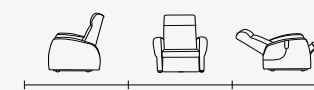

OH: 1180 OD: 900 EL: 1500
OW: 1110 SD: 600
SW: 880 SH: 480

Orion Page 67

RCBB01

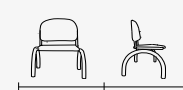

OH: 850 OD: 640
OW: 820 SD: 535
SW: 685 SH: 470

RCBB02

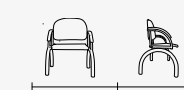

OH: 850 OD: 640
OW: 820 SD: 535
SW: 685 SH: 470

Whittle Page 64

747 / 747D

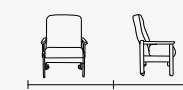

OH: 1090 OD: 800
OW: 735 SD: 510
SW: 610 SH: 510

747X / 747XD

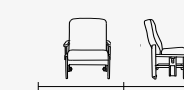

OH: 1090 OD: 800
OW: 825 SD: 510
SW: 710 SH: 510

747XX / 747XXD



OH: 1090 OD: 800
OW: 925 SD: 510
SW: 815 SH: 510

Sleepover Solutions

Buddy Page 70

*BDBU22
Buddy Compact
OW: 730
SW: 500

BDBU21 / BDBU22*



OH: 1170 OD: 870 EL: 2000
OW: 870 SD: 540
SW: 640 SH: 460

Mandy Page 76

SSMA24



OH: 910 OD: 900 EL: 2290
OW: 1120 SD: 550
SW: 925 SH: 490

SSMA25

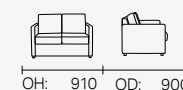

OH: 910 OD: 900 EL: 2290
OW: 1510 SD: 550
SW: 1330 SH: 490

SSMA26

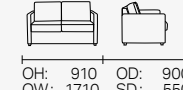

OH: 910 OD: 900 EL: 2290
OW: 1710 SD: 550
SW: 1530 SH: 490

Moby Page 72

BDMO01LH / RH



OH: 760 OD: 800 EL: 2350
OW: 1600 SD: 650
SW: 1300 SH: 470
Internal extended: 2000

Moby Compact Page 72

BDMO02LH / RH



OH: 980 OD: 800 EL: 2040
OW: 1540 SD: 540
SW: 1500 SH: 475
Internal extended: 2000

Moby Curve Page 74

BDMC01LH / RH



OH: 920 OD: 870 EL: 2050
OW: 1850 SD: 790
SW: 1550 SH: 520

Product Dimensions

OH = Overall Height
OW = Overall Width
OD = Overall Depth
OL = Overall Length
SW = Seat Width
SD = Seat Depth
SH = Seat Height
RS = Removable Seat
FS = Fixed Seat

All measurements in mm

Ward Furniture

Affiniti Page 86

BLAF51 / 52 / 53 / 54

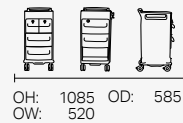

OH: 1085 OD: 585
OW: 520

Large Upper Drawer

Internal Length 455
Internal Width 380
Internal Height: Low/High 175/230

Twin Drawer Internal

Internal Length 430
Internal Width 155
Internal Height 190

Cascade Page 88

BLCC21 / 22



OH: 900 OD: 515
OW: 500

BLCC23 / 24



OH: 1475 OD: 515
OW: 752

Large Upper Drawer

Internal Length 425
Internal Width 425
Internal Height 260

Twin Drawer Upper Drawer

Internal Length 425
Internal Width 190
Internal Height 260

Cascade Plus + Pro Page 90

BLCC31 (PLUS)

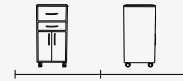

OH: 1050 OD: 515
OW: 505

BLCC41 (PRO)

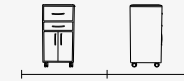

OH: 1140 OD: 575
OW: 555

Large Upper Drawer

Internal Length 425
Internal Width 425
Internal Height 260

Large Upper Drawer

Internal Length 425
Internal Width 475
Internal Height 290

Middle Drawer

Internal Length 425
Internal Width 425
Internal Height 90

Middle Drawer

Internal Length 425
Internal Width 475
Internal Height 140

Infiniti Page 84

Horseshoe base
internal width: 760

OBIN01

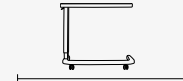

OH: 745-1100 OD: 430
OW: 900

OBIN02 / 03

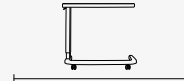

OH: 750-1095 OD: 435
OW: 905

Glide Page 92

MSGL01



OH/SH: 450-550
OW: 630 OD: 630
SW: 340 SD: 340

MSGL02



OH/SH: 405-505
OW: 630 OD: 630
SW: 340 SD: 340

MSGL05



OH/SH: 450-550
OW: 630 OD: 630
SW: 400 SD: 310

MSGL06



OH/SH: 405-505
OW: 630 OD: 630
SW: 400 SD: 310

MSGL03



OH/SH: 645-895
OW: 630 OD: 630
SW: 340 SD: 340

MSGL04



OH/SH: 605-850
OW: 630 OD: 630
SW: 340 SD: 340

MSGL07



OH/SH: 695-940
OW: 630 OD: 630
SW: 400 SD: 310

MSGL08



OH/SH: 685-930
OW: 630 OD: 630
SW: 400 SD: 310

MSGL09

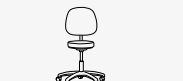

SH: 450-550
OH: 800-900
OW: 630 OD: 630
SW: 340 SD: 340

MSGL10



SH: 405-505
OH: 755-855
OW: 630 OD: 630
SW: 340 SD: 340

MSGL13



SH: 450-550
OH: 800-900
OW: 630 OD: 630
SW: 400 SD: 310

MSGL14



SH: 405-505
OH: 755-855
OW: 630 OD: 630
SW: 400 SD: 310

MSGL11



SH: 645-895
OH: 995-1245
OW: 630 OD: 630
SW: 340 SD: 340

MSGL12



SH: 605-850
OH: 1045-1290
OW: 630 OD: 630
SW: 340 SD: 340

MSGL15



SH: 695-940
OH: 1045-1290
OW: 630 OD: 630
SW: 400 SD: 310

MSGL16



SH: 685-930
OH: 1035-1280
OW: 630 OD: 630
SW: 400 SD: 310

Back to contents

KwickScreen Page 96

WFKW21 / 22 / 23 / 24

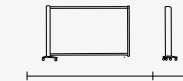

OH: 1900 OD: 310
OW: 3250

WFKW25 / 26 / 27 / 28

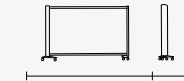

OH: 1900 OD: 520
OW: 3400

WFKW29 / 30 / 31 / 32

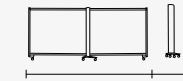

OH: 1900 OD: 520
OW: 6540

Patient Recliners

Astra Page 102

REAS21 / 21E / 22 / 23 / 23T



OH: 1180 OD: 900 EL: 1500
OW: 860 SD: 650
SW: 630 SH: 480

Astra Bariatric Page 102

REAS24



OH: 1180 OD: 900 EL: 1500
OW: 860 SD: 650
SW: 630 SH: 480

REAS25



OH: 1180 OD: 900 EL: 1500
OW: 1110 SD: 600
SW: 880 SH: 480

Avia Page 112

MRAV01 / 02



OH: 1270 OD: 910 EL: 1470
OW: 710 SD: 470
SW: 510 SH: 500

Astra Stellar Page 114

REST21 / 22



OH: 1150 OD: 900 EL: 1720
OW: 900 SD: 520
SW: 530 SH: 480

Astra Galaxy Page 108

REAG21 / 21E / 22 / 23 / 23T



OH: 1170 OD: 790 EL: 1740
OW: 730 SD: 520
SW: 520 SH: 480

Astra Club Page 104

REAS31 / 31E

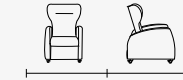

OH: 1100 OD: 760 EL: 1220
OW: 710 SD: 510
SW: 520 SH: 480

Astra Galaxy Bariatric Page 108

REAG24

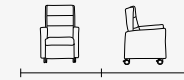

OH: 1170 OD: 790 EL: 1740
OW: 830 SD: 560
SW: 630 SH: 480

Nevis Page 110

*When headrest extended

RENE01 / 02

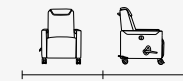

OH: 1180-1305* OD: 820 EL: 1865
OW: 780 SD: 530
SW: 585 SH: 520

Astra Lunar Page 106

RELU01 / 02 / 03 / 04 / 05 / 06 / 07 / 08

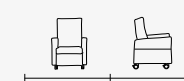

OH: 1150 OD: 940
OW: 820 SD: 500
SW: 540 SH: 475

Wynne Page 116

*770/771
OW: 700

760 / 761 / 770* / 771*

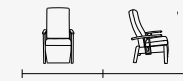

OH: 1170 OD: 785 EL: 1395
OW: 725 SD: 480
SW: 560 SH: 480

Product Dimensions

OH = Overall Height
OW = Overall Width
OD = Overall Depth
OL = Overall Length
SW = Seat Width

SD = Seat Depth
SH = Seat Height
RS = Removable Seat
FS = Fixed Seat

All measurements in mm

Waiting & Atrium

Adeo Page 124

RSAD2-SS

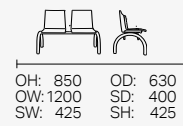

OH: 850 OD: 630
OW: 1200 SD: 400
SW: 425 SH: 425

RSAD2-SSS

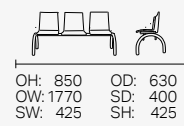

OH: 850 OD: 630
OW: 1770 SD: 400
SW: 425 SH: 425

RSAD2-ASSSA

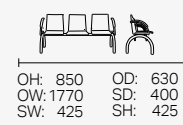

OH: 850 OD: 630
OW: 1770 SD: 400
SW: 425 SH: 425

RSAD2-ASSSSA

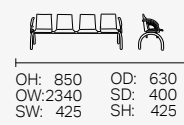

OH: 850 OD: 630
OW: 2340 SD: 400
SW: 425 SH: 425

RSAD2-4A

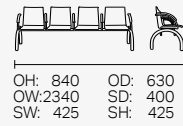

OH: 840 OD: 630
OW: 2340 SD: 400
SW: 425 SH: 425

RSAD2-01 / -02

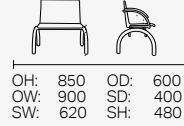

OH: 850 OD: 600
OW: 900 SD: 400
SW: 620 SH: 480

RSAD2-SSSS

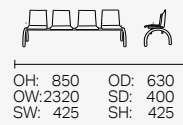

OH: 850 OD: 630
OW: 2320 SD: 400
SW: 425 SH: 425

RSAD2-ASSA

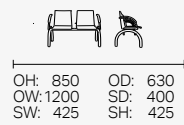

OH: 850 OD: 630
OW: 1200 SD: 400
SW: 425 SH: 425

RSAD2-ASASA

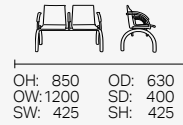

OH: 850 OD: 630
OW: 1200 SD: 400
SW: 425 SH: 425

RSAD2-ASASASA

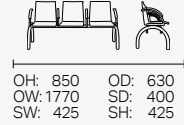

OH: 850 OD: 630
OW: 1770 SD: 400
SW: 425 SH: 425

Firenza Page 127

T88

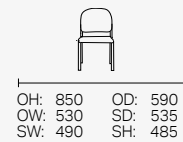

OH: 850 OD: 590
OW: 530 SD: 535
SW: 490 SH: 485

T89

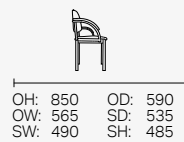

OH: 850 OD: 590
OW: 565 SD: 535
SW: 490 SH: 485

Lola Page 137

A821

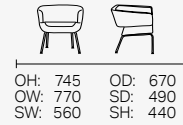

OH: 745 OD: 670
OW: 770 SD: 490
SW: 560 SH: 440

A822

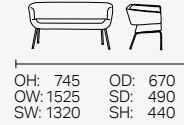

OH: 745 OD: 670
OW: 1525 SD: 490
SW: 1320 SH: 440

Core Beam Page 120

CRB-SS / CRB-ASSA CRB1-ASSA / CRB1-SS CRB2-SS / CRB2-ASSA



OH: 800 OD: 545
OW: 1265 SD: 410
SW: 450 SH: 440

CRB-SSS / CRB-ASSSA CRB1-ASSSA / CRB1-SSS CRB2-SSS / CRB2-ASSSA



OH: 880 OD: 545
OW: 1845 SD: 410
SW: 470 SH: 440

CRB-SSSS / CRB-ASSSSA CRB1-ASSSSA / CRB1-SSSS CRB2-SSSS / CRB2-ASSSSA



OH: 800 OD: 545
OW: 2285 SD: 410
SW: 450 SH: 440

Concha Page 137

CH1

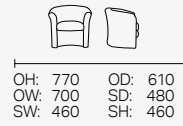

OH: 770 OD: 610
OW: 700 SD: 480
SW: 460 SH: 460

CH2

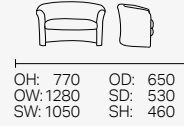

OH: 770 OD: 650
OW: 1280 SD: 530
SW: 1050 SH: 460

Earl Page 137

ERL1

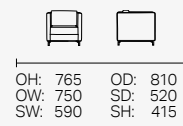

OH: 765 OD: 810
OW: 750 SD: 520
SW: 590 SH: 415

ERL2

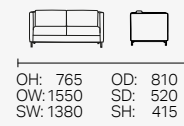

OH: 765 OD: 810
OW: 1550 SD: 520
SW: 1380 SH: 415

ERL3

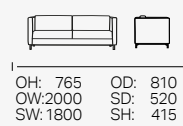

OH: 765 OD: 810
OW: 2000 SD: 520
SW: 1800 SH: 415

Herbie Page 134

HRB20

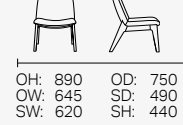

OH: 890 OD: 750
OW: 645 SD: 490
SW: 620 SH: 440

HRB70

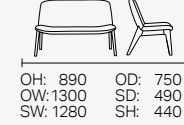

OH: 890 OD: 750
OW: 1300 SD: 490
SW: 1280 SH: 440

Back to contents

Waiting & Atrium

Haywood Page 122

B310-2A / B310-2L

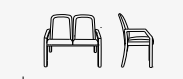

OH: 865 OD: 610
OW: 1105 SD: 430
SW: 470 SH: 455

B320-2A / B330-2



OH: 865 OD: 610
OW: 1105 SD: 430
SW: 470 SH: 455

B310A / 10L



OH: 865 OD: 610
OW: 595 SD: 430
SW: 470 SH: 455

RSHA01

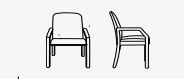

OH: 865 OD: 610
OW: 900 SD: 430
SW: 795 SH: 455

B310-3A / 3L



OH: 865 OD: 610
OW: 1650 SD: 430
SW: 470 SH: 455

B320-3A / B330-3



OH: 865 OD: 610
OW: 1650 SD: 430
SW: 470 SH: 455

B315 / B3030



OH: 455 OD: 760
OW: 760

Inverto Page 136

RSIV01

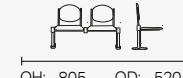

OH: 805 OD: 520
OW: 1035 SD: 415
SW: 435 SH: 460

RSIV02

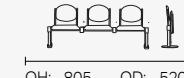

OH: 805 OD: 520
OW: 1555 SD: 415
SW: 435 SH: 460

RSIV03

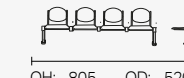

OH: 805 OD: 520
OW: 2075 SD: 415
SW: 435 SH: 460

RSIV04

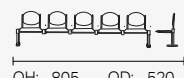

OH: 805 OD: 520
OW: 2595 SD: 415
SW: 435 SH: 460

Orion Page 126

A180-ASSA

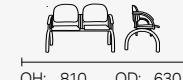

OH: 810 OD: 630
OW: 1150 SD: 535
SW: 490 SH: 490

A180-ASSSA

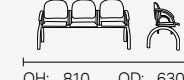

OH: 810 OD: 630
OW: 1725 SD: 535
SW: 490 SH: 490

A180-TS

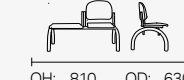

OH: 810 OD: 630
OW: 1150 SD: 535
SW: 490 SH: 490

A180-TASA



OH: 810 OD: 630
OW: 1150 SD: 535
SW: 490 SH: 490

A180-SS



OH: 810 OD: 630
OW: 1150 SD: 535
SW: 490 SH: 490

A180-SSS

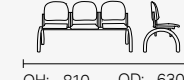

OH: 810 OD: 630
OW: 1725 SD: 535
SW: 490 SH: 490

A180-ASA



OH: 810 OD: 630
OW: 575 SD: 535
SW: 490 SH: 490

A180-S



OH: 810 OD: 630
OW: 575 SD: 535
SW: 490 SH: 490

A180-SSSS / ASSSSA

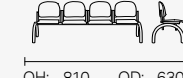

OH: 810 OD: 630
OW: 2300 SD: 535
SW: 490 SH: 490

RCBB01



OH: 850 OD: 640
OW: 820 SD: 535
SW: 685 SH: 470

RCBB02



OH: 850 OD: 640
OW: 820 SD: 535
SW: 685 SH: 470

Tolero Bench Page 130

RSTL-2S



OH: 1000 OD: 700
OW: 1140 SD: 490
SW: 1050 SH: 490

RSTL-2SA

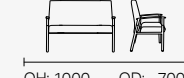

OH: 1000 OD: 700
OW: 1155 SD: 490
SW: 1050 SH: 490

RSTL-3S

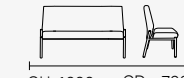

OH: 1000 OD: 700
OW: 1685 SD: 490
SW: 1595 SH: 490

RSTL-3SA

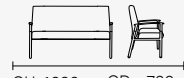

OH: 1000 OD: 700
OW: 1700 SD: 490
SW: 1595 SH: 490

Product Dimensions

OH = Overall Height
 OW = Overall Width
 OD = Overall Depth
 OL = Overall Length
 SW = Seat Width
 SD = Seat Depth
 SH = Seat Height
 RS = Removable Seat
 FS = Fixed Seat

All measurements in mm

Waiting & Atrium

Tolero Beam Page 128

RSTL-SS



OH: 1000 OD: 700
 OW: 1140 SD: 490
 SW: 500 SH: 490

RSTL-ASSA



OH: 1000 OD: 700
 OW: 1155 SD: 490
 SW: 500 SH: 490

RSTL-ASASA



OH: 1000 OD: 700
 OW: 1155 SD: 490
 SW: 500 SH: 490

RSTL-SSS



OH: 1000 OD: 700
 OW: 1690 SD: 490
 SW: 500 SH: 490

RSTL-ASSSA



OH: 1000 OD: 700
 OW: 1705 SD: 490
 SW: 500 SH: 490

RSTL-ASASASA



OH: 1000 OD: 700
 OW: 1705 SD: 490
 SW: 500 SH: 490

RSTL-SSSS



OH: 1000 OD: 700
 OW: 2240 SD: 490
 SW: 500 SH: 490

RSTL-ASSSSA



OH: 1000 OD: 700
 OW: 2255 SD: 490
 SW: 500 SH: 490

RSTL-4SEIA

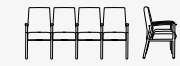

OH: 1000 OD: 700
 OW: 2255 SD: 490
 SW: 500 SH: 490

Quad Page 132

90° Corner units*
 Diagonal Length
 (DL): 1840

650w Seat Unit



OH: 880 OD: 660
 OW: 650 SD: 490
 SW: 650 SH: 470

1300w 2 Seater Unit

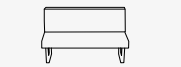

OH: 880 OD: 660
 OW: 1300 SD: 490
 SW: 1300 SH: 470

Internal 90° Corner Unit *



OH: 880 OD: 660
 OW: 1300 SD: 490
 SW: 680 SH: 470

External 90° Corner Unit *



OH: 880 OD: 660
 OW: 1300 SD: 490
 SW: 2000 SH: 470

Back to contents

Office & Multi-purpose

Orthopaedica Page 145

OC97



OH: 1090-1280 OD: 640
 OW: 660 SD: 480
 SW: 510 SH: 460-570

OC97HA



OH: 1090-1280 OD: 640
 OW: 660 SD: 480
 SW: 510 SH: 460-570
 AH: 190-250

OC97FDA



OH: 1090-1280 OD: 640
 OW: 660 SD: 480
 SW: 510 SH: 460-570
 AH: 190-250

Saturn Page 142

*Fixed Arms
 Arm Height:
 180

**Height
 Adjustable Arms
 Arm Height:
 180-260

STN10 / STN16



OH: 900-1090 OD: 680
 OW: 680 SD: 460
 SW: 490 SH: 490-600

STN10A* / 16A* STN10HA** / 16HA**



OH: 900-1090 OD: 680
 OW: 680 SD: 460
 SW: 490 SH: 490-600

STN10V / 10VA*



OH: 830 OD: 600
 OW: 450 SD: 400
 SW: 470 SH: 500

STN10D



OH: 960-1310 OD: 690
 OW: 690 SD: 440
 SW: 470 SH: 640-900

STN50 / STN56



OH: 920-1110 OD: 680
 OW: 680 SD: 460
 SW: 490 SH: 490-600

STN50A* / 56A* STN50HA** / 56HA**



OH: 900-1090 OD: 680
 OW: 680 SD: 460
 SW: 490 SH: 490-600

Harlen Page 140

SFHA01



OH: 900-1030 OD: 590
 OW: 580 SD: 450
 SW: 470 SH: 465-595

SFHA02



OH: 945-1075 OD: 560
 OW: 550 SD: 430
 SW: 455 SH: 420-550

SFHA03



OH: 1050-1310 OD: 590
 OW: 580 SD: 450
 SW: 470 SH: 600-850

SFHA04



OH: 1050-1305 OD: 560
 OW: 550 SD: 430
 SW: 445 SH: 570-830

SFHA05



OH: 470-670 OD: 405
 OW: 570 SD: 355
 SW: 445 SH: 430-620

SFHA06



OH: 470-670 OD: 405
 OW: 650 SD: 355
 SW: 445 SH: 430-620

Sofa's & Armchairs

Anumo Page 180

SSAU01



OH: 980 OD: 760
 OW: 1540 SD: 640
 SW: 1300 SH: 480

SSAU02



OH: 900 OD: 760
 OW: 740 SD: 640
 SW: 520 SH: 480

Asuka Page 182

SSRA01X



OH: 780 OD: 1010
 OW: 1250 SD: 610
 SW: 530 SH: 430

SSRA02X



OH: 780 OD: 1010
 OW: 1980 SD: 610
 SW: 1250 SH: 430

SSRA03X

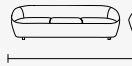

OH: 780 OD: 1010
 OW: 2660 SD: 610
 SW: 1930 SH: 430

Product Dimensions

OH = Overall Height
OW = Overall Width
OD = Overall Depth
OL = Overall Length
SW = Seat Width

SD = Seat Depth
SH = Seat Height
RS = Removable Seat
FS = Fixed Seat

All measurements in mm

Sofa's & Armchairs

Atlas Page 188

LSAT01 / 01RS

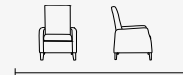

OH: 1280 OD: 885
OW: 720 SD: 550
SW: 535 SH: 500

LSAT02 / 02RS



OH: 1280 OD: 885
OW: 720 SD: 550
SW: 535 SH: 500

LSAT03 / 03RS

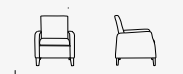

OH: 800 OD: 885
OW: 720 SD: 550
SW: 535 SH: 500

LSAT11



OH: 1140 OD: 885
OW: 810 SD: 550
SW: 650 SH: 500

Berkeley Page 195

LSBE01 / 21

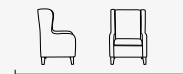

OH: 1120 OD: 730
OW: 730 SD: 550
SW: 550 SH: 460

Christie Page 168

TSCH21



OH: 780 OD: 700
OW: 790 SD: 550
SW: 560 SH: 480

TSCH22



OH: 940 OD: 700
OW: 790 SD: 550
SW: 560 SH: 480

TSCH23



OH: 1090 OD: 700
OW: 780 SD: 550
SW: 560 SH: 480

TSCH24



OH: 940 OD: 700
OW: 1210 SD: 550
SW: 980 SH: 480

TSCH25



OH: 780 OD: 670
OW: 780 SD: 540
SW: 530 SH: 480

Athena Page 177

RSAH01

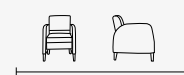

OH: 850 OD: 850
OW: 690 SD: 550
SW: 525 SH: 480

RSAH02



OH: 850 OD: 850
OW: 1215 SD: 550
SW: 1050 SH: 480

Brunswick Page 167

SSBR01



OH: 1060 OD: 800
OW: 800 SD: 500
SW: 500 SH: 470

Belgrave Page 190

LSBG02



OH: 1140 OD: 790
OW: 730 SD: 490
SW: 480 SH: 470

LSBG04



OH: 1140 OD: 790
OW: 1140 SD: 530
SW: 960 SH: 470

Chesterfield Page 184

SSCF21



OH: 760 OD: 960
OW: 730 SD: 640
SW: 420 SH: 490

SSCF22



OH: 760 OD: 960
OW: 1780 SD: 640
SW: 1040 SH: 490

SSCF23

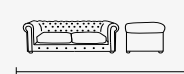

OH: 760 OD: 960
OW: 2250 SD: 640
SW: 1600 SH: 490

SSCF24

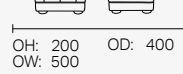

OH: 200 OD: 400
OW: 500

SSEV01



OH: 780 OD: 860
OW: 700 SD: 540
SW: 530 SH: 480

SSEV02



OH: 960 OD: 860
OW: 700 SD: 540
SW: 530 SH: 480

SSEV03 / 04



OH: 1230 OD: 860
OW: 890 SD: 540
SW: 540 SH: 480

SSEV05



OH: 890 OD: 860
OW: 1250 SD: 540
SW: 1100 SH: 480

Back to contents

Sofa's & Armchairs Continued

Galloway Page 166

SSGA01

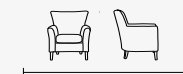

OH: 890 OD: 790
OW: 760 SD: 520
SW: 480 SH: 470

SSGA02



OH: 890 OD: 790
OW: 1270 SD: 520
SW: 1000 SH: 470

SSGA03

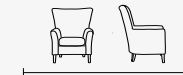

OH: 1020 OD: 790
OW: 760 SD: 520
SW: 480 SH: 470

SSGA04

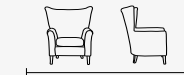

OH: 1060 OD: 870
OW: 900 SD: 520
SW: 480 SH: 470

SSGA05



OH: 455 OD: 455
OW: 395

Idro Page 172

LSID01



OH: 750 OD: 840
OW: 1043 SD: 550
SW: 530 SH: 455

LSID02



OH: 750 OD: 840
OW: 1713 SD: 550
SW: 1160 SH: 455

LSID03

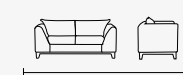

OH: 750 OD: 840
OW: 2313 SD: 610
SW: 1760 SH: 470

Jasper Page 195

SSJA01

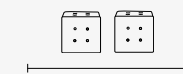

OH: 450 OD: 450
OW: 450

Keppler Page 193

LSKP01



OH: 830 OD: 730
OW: 715 SD: 500
SW: 540 SH: 450

Hinchley Page 185

LSHI21



OH: 900 OD: 810
OW: 860 SD: 500
SW: 500 SH: 490

LSHI22



OH: 1030 OD: 840
OW: 860 SD: 500
SW: 500 SH: 490

LSHI23

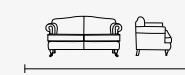

OH: 900 OD: 810
OW: 1600 SD: 500
SW: 1290 SH: 490

Keilder Page 178

SSKE01



OH: 900 OD: 830
OW: 940 SD: 510
SW: 500 SH: 475

SSKE02



OH: 900 OD: 830
OW: 1700 SD: 510
SW: 1280 SH: 475

SSKE03



OH: 900 OD: 830
OW: 2100 SD: 510
SW: 1650 SH: 475

Jem Page 179

SSJM01



OH: 840 OD: 800
OW: 920 SD: 560
SW: 490 SH: 455

SSJM02

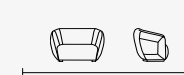

OH: 840 OD: 800
OW: 1510 SD: 560
SW: 1090 SH: 455

SSJM03

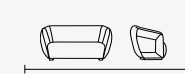

OH: 840 OD: 800
OW: 1900 SD: 560
SW: 1480 SH: 455

SSJM04

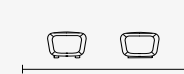

OH: 370 OD: 590
OW: 590

Linx Page 176

LNK1



OH: 880 OD: 930
OW: 640 SD: 445
SW: 640 SH: 445

LNK2



OH: 880 OD: 930
OW: 940 SD: 565
SW: 940 SH: 445

LNK3

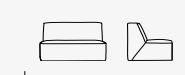

OH: 880 OD: 930
OW: 1240 SD: 565
SW: 1240 SH: 445

Arm Unit:

OH: 620
OW: 190
OD: 940

Product Dimensions

OH = Overall Height
OW = Overall Width
OD = Overall Depth
SW = Seat Width
SD = Seat Depth
SH = Seat Height
RS = Removable Seat
FS = Fixed Seat

All measurements in mm

Sofa's & Armchairs Continued

Mandy Page 173

SSMA21

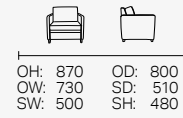

SSMA22

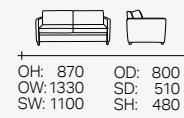

SSMA23

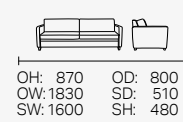

Murano Page 183

SSMU02X+

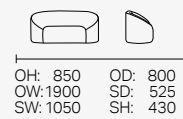

Olivia Page 170

SSOV01/21

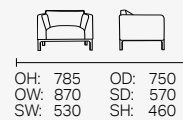

SSOV02/22

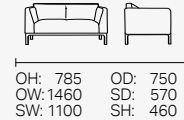

SSOV03/23

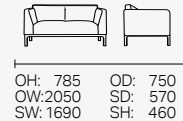

Umbria Page 193

SSUM01

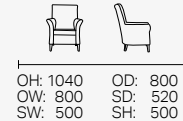

SSUM02

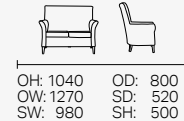

Pimlico Page 166

LSPI01 / 02

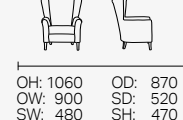

Marli Page 187

SSMR01X

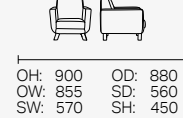

SSMR02X

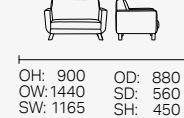

SSMR03X

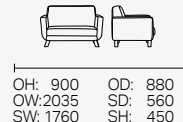

Maldivo Page 174

SSML01 / 21

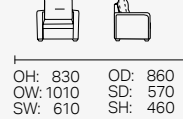

SSML02 / 22

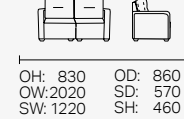

SSML03 / 23

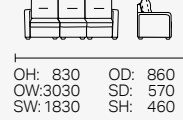

SSML31

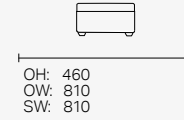

Orla Page 186

SSOR01

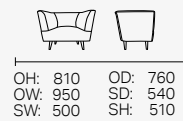

SSOR02

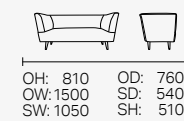

SSOR03

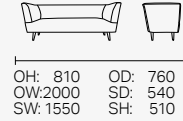

Velvare Page 190

LSVE05

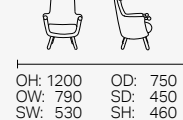

LSVE06

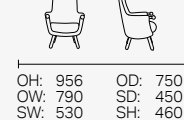

Back to contents

Sofa's & Armchairs Continued

Vista Page 192

LSVI01 / 02 / 03

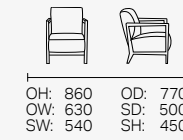

Zenda Page 194

LSZE21

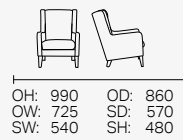

LSZE22

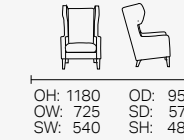

LSZE23

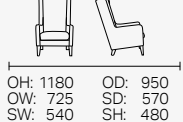

LSZE24

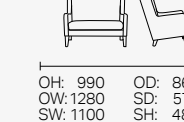

LSZE25

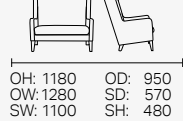

LSZE26

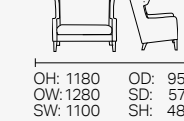

Virtuoso Page 191

LSVR01

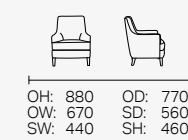

LSVR02

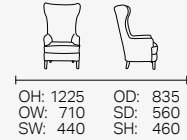

LSVR04

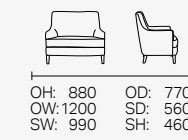

LSVR05

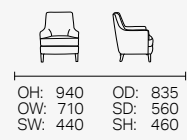

LSVR03

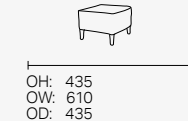

LSVR06

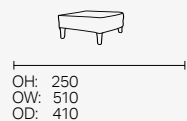

Modular Sofas

Et'Cetera Page 201

T1000R

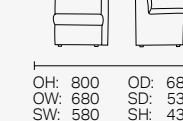

T1000L

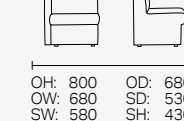

T1000

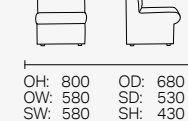

Linx Page 198

LNx1

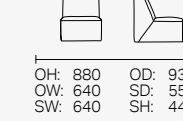

LNx2

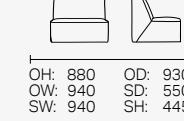

LNx3

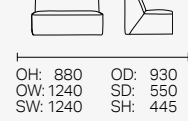

LNx4

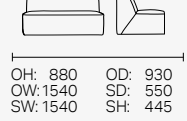

LNx8*
OH: 940
OD: 940

LNx5

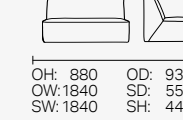

LNx6

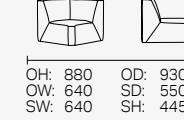

LNx7 / 8*

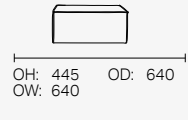

LNx9

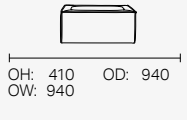

Product Dimensions

OH = Overall Height
OW = Overall Width
OD = Overall Depth
OL = Overall Length
SW = Seat Width

SD = Seat Depth
SH = Seat Height
RS = Removable Seat
FS = Fixed Seat

All measurements in mm

Modular Sofas Continued

Maldivo Page 200

SSML-1

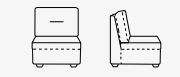

OH: 830 OD: 860
OW: 610 SD: 570
SW: 610 SH: 460

SSML-1A

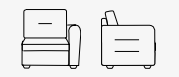

OH: 830 OD: 860
OW: 810 SD: 570
SW: 610 SH: 460

SSML-A1

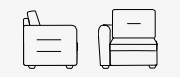

OH: 830 OD: 860
OW: 810 SD: 570
SW: 610 SH: 460

SSML-C



OH: 830 OD: 860
OW: 860 SD: 570
SW: 570 SH: 460

Note Page 201

MTE-SF01



OH: 835 OD: 730
OW: 1000 SD: 550
SW: 1000 SH: 470

MTE-SF02



OH: 835 OD: 730
OW: 1600 SD: 550
SW: 1600 SH: 470

Soltaire Page 202

TSSO05X
OW: 1460
OD: 1460
OH: 880

TSSO06X
OW: 2050
OD: 1460
OH: 880

TSSO07X
OW: 1460
OD: 2050
OH: 880

TSSO08X
OW: 2050
OD: 2050
OH: 880

TSSO01X



OH: 880 OD: 820
OW: 600 SD: 560
SW: 600 SH: 450

TSSO02X



OH: 880 OD: 820
OW: 1200 SD: 560
SW: 1200 SH: 450

TSSO03X



OH: 880 OD: 820
OW: 1800 SD: 560
SW: 1800 SH: 450

TSSO04X



OH: 450
OW: 730
OD: 730

Tub & Utility

Meridian Page 214

TSME01X



OH: 770 OD: 720
OW: 740 SD: 560
SW: 540 SH: 450

TSME02X



OH: 770 OD: 720
OW: 1240 SD: 560
SW: 1050 SH: 450

Fawley Page 210

TSFA01

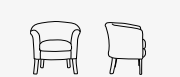

OH: 820 OD: 685
OW: 770 SD: 510
SW: 460 SH: 510

TSFA02



OH: 820 OD: 685
OW: 1270 SD: 510
SW: 990 SH: 510

Suki Page 206

TSSU01



OH: 850 OD: 720
OW: 740 SD: 520
SW: 500 SH: 460

TSSU03



OH: 805 OD: 720
OW: 1240 SD: 520
SW: 1000 SH: 460

Felicity Page 209

LSFE01



OH: 915 OD: 635
OW: 565 SD: 470
SW: 545 SH: 495

Roku® Page 217

TSRK23

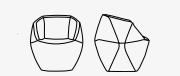

OH: 805 OD: 795
OW: 775 SD: 475
SW: 465 SH: 435

TSRK22 / 21 / 25

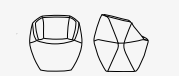

OH: 805 OD: 795
OW: 775 SD: 475
SW: 465 SH: 435

TARK21 / TSRK24



OH: 480 OD: 795
OW: 775

[Back to contents](#)

Tub & Utility Continued

Thatcher Page 216

T2023

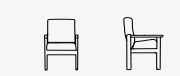

OH: 840 OD: 710
OW: 660 SD: 550
SW: 550 SH: 460

T2012

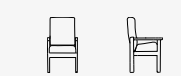

OH: 965 OD: 710
OW: 660 SD: 550
SW: 550 SH: 380

T2013



OH: 1040 OD: 710
OW: 660 SD: 550
SW: 550 SH: 460

T1011CUR



OH: 760 OD: 710
OW: 610 SD: 550
SW: 550 SH: 455

T1012CUR



OH: 760 OD: 710
OW: 660 SD: 550
SW: 550 SH: 455

Pixie Page 215

DCPI01



OH: 870 OD: 610
OW: 490 SD: 445
SW: 470 SH: 470

DCPI02



OH: 865 OD: 580
OW: 550 SD: 440
SW: 450 SH: 460

DCPI03



OH: 1050 OD: 610
OW: 490 SD: 445
SW: 470 SH: 470

DCPI04



OH: 1050 OD: 580
OW: 550 SD: 440
SW: 450 SH: 460

Valentino Page 212

TSVA01



OH: 830 OD: 610
OW: 640 SD: 440
SW: 470 SH: 460

TSVA02



OH: 830 OD: 610
OW: 1270 SD: 440
SW: 990 SH: 460

Dining & Café Chairs

Adriatic Page 222

S334 / S336



OH: 990 OD: 550
OW: 470 SD: 430
SW: 470 SH: 480

S335 / S337



OH: 990 OD: 550
OW: 520 SD: 430
SW: 470 SH: 480

Charlotte Page 227

C500-1



OH: 850 OD: 575
OW: 545 SD: 440
SW: 480 SH: 495

C502-1



OH: 850 OD: 575
OW: 545 SD: 440
SW: 480 SH: 495

Arlo Page 234

ARL10 / 11



OH: 825 OD: 525
OW: 545 SD: 410
SW: 460 SH: 465

ARL10A / 11A



OH: 825 OD: 525
OW: 585 SD: 410
SW: 460 SH: 465

Anne Page 226

C501-1



OH: 850 OD: 575
OW: 545 SD: 440
SW: 480 SH: 495

C503-1



OH: 850 OD: 575
OW: 545 SD: 440
SW: 480 SH: 495

Product Dimensions

OH = Overall Height
OW = Overall Width
OD = Overall Depth
OL = Overall Length
SW = Seat Width

SD = Seat Depth
SH = Seat Height
RS = Removable Seat
FS = Fixed Seat

All measurements in mm

Dining & Café Chairs Continued

Avenue Page 224

DCAV01/08

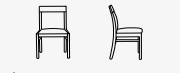

OH: 875 OD: 530
OW: 480 SD: 405
SW: 480 SH: 490

DCAV02/09

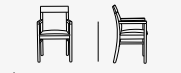

OH: 875 OD: 530
OW: 555 SD: 405
SW: 480 SH: 490

Henley Page 221

DCHE01



OH: 865 OD: 600
OW: 560 SD: 455
SW: 430 SH: 455

Ikon Page 235

DCIK01 / 03

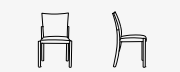

OH: 845 OD: 580
OW: 580 SD: 500
SW: 500 SH: 460

DCIK02 / 04

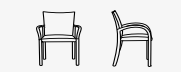

OH: 845 OD: 580
OW: 600 SD: 430
SW: 430 SH: 460

Kasumi Page 228

DCKA01/ 05



OH: 850 OD: 550
OW: 480 SD: 420
SW: 480 SH: 490

DCKA02 / 06



OH: 850 OD: 550
OW: 560 SD: 420
SW: 480 SH: 490

Kurva Page 229

*DCKU03
OH: 1000

DCKU01

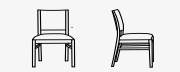

OH: 900 OD: 540
OW: 470 SD: 420
SW: 470 SH: 510

DCKU02/03*



OH: 900 OD: 580
OW: 560 SD: 440
SW: 470 SH: 510

Ophelia Page 233

DCOP01



OH: 820 OD: 580
OW: 560 SD: 480
SW: 430 SH: 490

Waldorf Page 223

DCWA01 / 02



OH: 920 OD: 450
OW: 595 SD: 410
SW: 470 SH: 460

DCWA03 / 04



OH: 920 OD: 460
OW: 470 SD: 410
SW: 470 SH: 460

Pixie Page 232

DCPI01



OH: 870 OD: 610
OW: 490 SD: 445
SW: 470 SH: 470

DCPI02



OH: 865 OD: 580
OW: 550 SD: 440
SW: 450 SH: 460

Zenda Page 220

DCZE01



OH: 830 OD: 690
OW: 560 SD: 470
SW: 480 SH: 500

Zinnia Page 231

DCZI01 / 02



OH: 800 OD: 500
OW: 520 SD: 490
SW: 500 SH: 450

DCZI03 / 04



OH: 800 OD: 520
OW: 520 SD: 490
SW: 500 SH: 450

DCZI05 / 06



OH: 1100 OD: 520
OW: 510 SD: 500
SW: 510 SH: 700

Back to contents

Stacking Chairs

Charlotte Page 242

C500-1



OH: 850 OD: 575
OW: 545 SD: 440
SW: 480 SH: 495

C502-1



OH: 850 OD: 575
OW: 545 SD: 440
SW: 480 SH: 495

Breeze Page 243

*other seat height options available

DCBR01*



OH: 500 OD: 330
OW: 350 SD: 250
SW: 280 SH: 260

Other seat height options available:

DCBR02 SH: 310
DCBR03 SH: 350
DCBR04 SH: 380
DCBR05 SH: 430
DCBR06 SH: 460

Anne Page 242

C501-1



OH: 850 OD: 575
OW: 545 SD: 440
SW: 480 SH: 495

C503-1



OH: 850 OD: 575
OW: 545 SD: 440
SW: 480 SH: 495

Core Page 238

CRE1 / 2 / 3



OH: 815 OD: 570
OW: 710 SD: 410
SW: 455 SH: 450

CRE1A / 2A / 3A



OH: 815 OD: 570
OW: 710 SD: 410
SW: 455 SH: 450

Arlo Page 240

ARL10 / 11



OH: 825 OD: 525
OW: 545 SD: 410
SW: 460 SH: 465

ARL10A / 11A



OH: 825 OD: 525
OW: 585 SD: 410
SW: 460 SH: 465

Ikon Page 241

DCIK03



OH: 845 OD: 580
OW: 580 SD: 500
SW: 500 SH: 460

DCIK04



OH: 845 OD: 580
OW: 600 SD: 430
SW: 430 SH: 460

Kurva Page 229

*DCKU03
OH: 1000

DCKU01

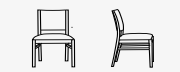

OH: 900 OD: 540
OW: 470 SD: 420
SW: 470 SH: 510

DCKU02/03*



OH: 900 OD: 580
OW: 560 SD: 440
SW: 470 SH: 510

Ophelia Page 233

DCOP01



OH: 820 OD: 580
OW: 560 SD: 480
SW: 430 SH: 490

Waldorf Page 223

DCWA01 / 02



OH: 920 OD: 450
OW: 595 SD: 410
SW: 470 SH: 460

DCWA03 / 04



OH: 920 OD: 460
OW: 470 SD: 410
SW: 470 SH: 460

Pixie Page 232

DCPI01



OH: 870 OD: 610
OW: 490 SD: 445
SW: 470 SH: 470

DCPI02



OH: 865 OD: 580
OW: 550 SD: 440
SW: 450 SH: 460

Zenda Page 220

DCZE01



OH: 830 OD: 690
OW: 560 SD: 470
SW: 480 SH: 500

Zinnia Page 231

DCZI01 / 02



OH: 800 OD: 500
OW: 520 SD: 490
SW: 500 SH: 450

DCZI03 / 04



OH: 800 OD: 520
OW: 520 SD: 490
SW: 500 SH: 450

DCZI05 / 06



OH: 1100 OD: 520
OW: 510 SD: 500
SW: 510 SH: 700

Firenza Page 241

T88



OH: 850 OD: 590
OW: 530 SD: 535
SW: 490 SH: 485

T89



OH: 850 OD: 590
OW: 565 SD: 535
SW: 490 SH: 485

Luca Page 243

RSLU01



OH: 830 OD: 510
OW: 570 SD: 400
SW: 390 SH: 460

Zola Page 243

DCZL01



OH: 820 OD: 560
OW: 460 SD: 400
SW: 425 SH: 455

DCZL02



OH: 820 OD: 560
OW: 570 SD: 400
SW: 425 SH: 455

Vox Page 240

PSVX01



OH: 800 OD: 540
OW: 510 SD: 440
SW: 470 SH: 410

Product Dimensions

OH = Overall Height
OW = Overall Width
OD = Overall Depth
OL = Overall Length
SW = Seat Width

SD = Seat Depth
SH = Seat Height
RS = Removable Seat
FS = Fixed Seat

All measurements in mm

Beds + Mattresses

Falkland Page 295

**FDBED5
OW: 1219

*FDBED4
OW: 1350

FDBED3 / 4* / 5**

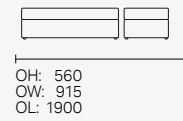

Malta Page 294

**MABED5
OW: 1219

*MABED4
OW: 1350

MABED3 / 4* / 5**

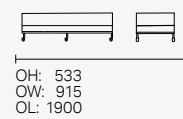

Olsen Page 293

*BDOL03
OW: 1380

BDOL01

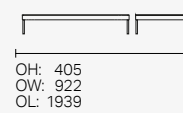

BDOL02 / 3*

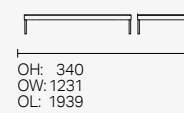

Nautilus Mattress Page 297

*NMAT3
OW: 1220

*NMAT2
OW: 1403

NMAT1 / 2* / 3*

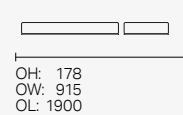

Standard Mattress Page 297

*BDSM02
OW: 1403

BDSM01 / 02*

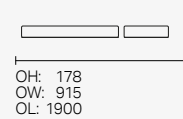

Guernsey Page 294

**GUBED5
OW: 1219

*GUBED4
OW: 1350

GUBED3 / 4* / 5**

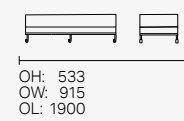

Skye Page 295

**SKMBED5
OW: 1219

*SKMBED4
OW: 1350

SKMBED3 / 4* / 5**

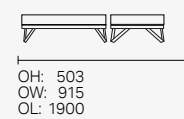

Keswick Damask Mattress Page 297

**FDMAT5
OW: 1219

*FDMAT4
OW: 1350

FDMAT3 / 4* / 5**

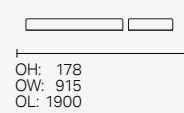

PVC Mattress Page 297

*PVC MAT3
OW: 1220

*PVC MAT2
OW: 1403

PVC MAT1 / 2* / 3*

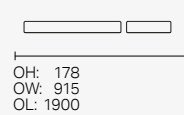

[Back to contents](#)

Beds + Mattresses Continued

Upholstered Headboards Page 296

BDHB31 (Wall Fixed)

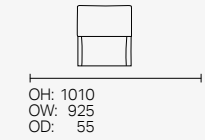

BDHB41 (Bed Fixed)

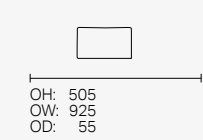

BDHB32 (Wall Fixed)

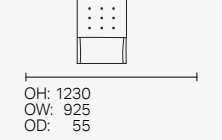

BDHB42 (Bed Fixed)

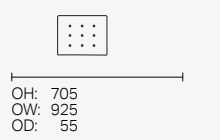

BDHB33 (Wall Fixed)

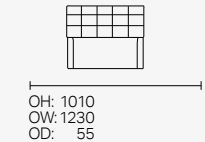

BDHB43 (Bed Fixed)

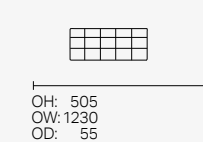

BDHB34 (Wall Fixed)

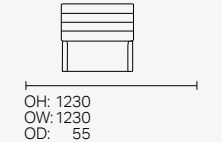

BDHB44 (Bed Fixed)

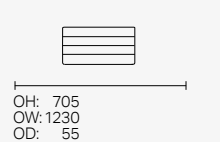

BDHB35 (Wall Fixed)

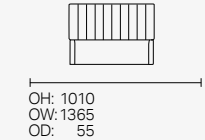

BDHB45 (Bed Fixed)

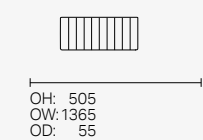

BDHB36 (Wall Fixed)

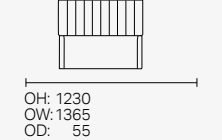

BDHB46 (Bed Fixed)

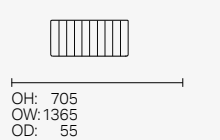

Wooden Headboards Page 296

HB1 (Bed Fixed)

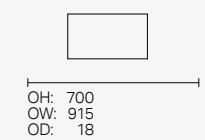

HB2 (Bed Fixed)

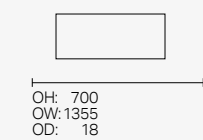

HB5 (Bed Fixed)

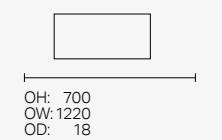

HB3 (Wall Fixed)

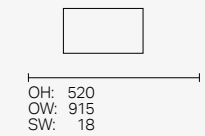

HB4 (Wall Fixed)

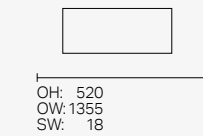

HB6 (Wall Fixed)

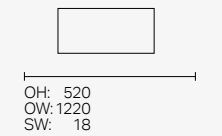

Rotomoulded Bedroom

Roku® Bedroom Page 298

Height to mattress
platform: 458

*RKBD02
with bedside storage

RKBD01 / 02*

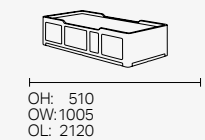

RKBS01

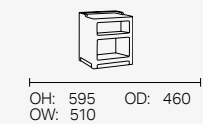

RKWU01

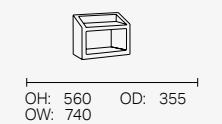

RKWU02



RKDK01

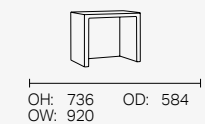

RKCH02 / 03

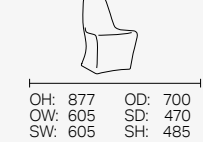

RKMT01 / 02 / 03 / 04

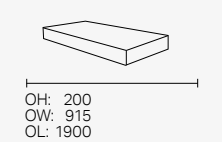

Outdoor Furniture

Roku® Outdoor Page 302

DCRK01



OH: 810 OD: 615
OW: 510 SD: 450
SW: 490 SH: 450

TSRK27

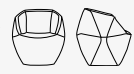

OH: 805 OD: 795
OW: 775 SD: 475
SW: 465 SH: 435

RKCH01



OH: 833 OD: 647
OW: 585 SD: 482
SW: 585 SH: 441

RKCH02



OH: 877 OD: 700
OW: 605 SD: 470
SW: 605 SH: 485

RKMN01



OH: 840 OD: 790
OW: 765 SD: 470
SW: 610 SH: 445

RKMN03



OH: 840 OD: 790
OW: 940 SD: 470
SW: 790 SH: 445

TARK21



OH: 480 OD: 795
OW: 775

RKTA08



OH: 745
OW: 900

RKTA09



OH: 745
OW: 1100

Button Page 304

RKBU01



OH: 725 OD: 740
OW: 985

RKBU02



OH: 450 OD: 360
OW: 480

Tibo Page 306

TW = Table Width
TD = Table Depth

TORD

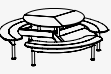

OH: 740 OD: 2227
OW: 2227 TD: 1240
TW: 1240 SH: 448

TOMO

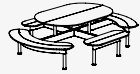

OH: 740 OD: 2080
OW: 2642 TD: 1100
TW: 1662 SH: 448

TOLO

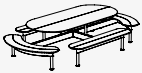

OH: 740 OD: 2080
OW: 3380 TD: 1100
TW: 2400 SH: 448

Zola Page 305

DCZL01



OH: 820 OD: 560
OW: 460 SD: 400
SW: 425 SH: 455

DCZL02



OH: 820 OD: 560
OW: 570 SD: 400
SW: 425 SH: 455

Luca Page 305

RSLU01



OH: 830 OD: 510
OW: 570 SD: 400
SW: 390 SH: 460

Tonina Page 305

RSTN01



OH: 810 OD: 520
OW: 505 SD: 420
SW: 390 SH: 465

RSTN02



OH: 810 OD: 520
OW: 575 SD: 420
SW: 390 SH: 465

RSTN03



OH: 810 OD: 520
OW: 505 SD: 420
SW: 390 SH: 485

RSTN04



OH: 810 OD: 520
OW: 575 SD: 420
SW: 390 SH: 495

Crop Page 307

CRP02



OH: 835 OD: 555
OW: 620 SD: 435
SW: 490 SH: 480

CRP03



OH: 730 OD: 675
OW: 675 SD: 490
SW: 510 SH: 420

CRP05



OH: 1015 OD: 505
OW: 475 SD: 390
SW: 425 SH: 780

Teal is an award winning provider of innovative, high quality patient seating, ward furniture and medical equipment for healthcare. The major provider to the NHS throughout the UK.

Our products focus on infection control, pressure management and manual handling and help to promote patient dignity, staff safety and contribute towards a therapeutic and healing patient environment.

teal

Branch Road
Lower Darwen
Lancashire
BB3 0PR

Tel: +44 (0) 1254 688210
Sales Freephone: 0800 980 8998
Email: sales@teal.co.uk
www.teal.co.uk

The Senator Group