

SOLUTIONS FOR HEALTHCARE

# Challenging Environments Furniture



**teal**



# teal

At Teal, we believe thoughtfully designed environments can positively influence wellbeing, recovery and everyday experiences.

As a British manufacturer with decades of expertise in challenging environments, we design and manufacture high-quality furniture that balances safety, durability and contemporary design. Our products support the complex needs of settings, ranging from residential and dementia care to custodial and mental health environments.

We work closely with providers to help solve the everyday challenges faced by care and support teams, creating spaces that feel welcoming, therapeutic and built around the people who use them.

Our end-to-end manufacturing approach gives us complete control over quality, consistency and lead times, allowing us to deliver durable, design-led solutions that offer long-term value.

Through specialist expertise and thoughtful design, we help create environments that support recovery, enrich lives and improve outcomes.



## Contents

<b>Introduction</b>	01 - 33
<b>Roku® Family</b>	34 - 57
<b>Dining &amp; Coffee Tables</b>	58 - 78
<b>Dining Chairs</b>	79 - 93
<b>Stacking Chairs</b>	94 - 97
<b>Sofa's &amp; Armchairs</b>	98 - 143
<b>Tub &amp; Multi-use Chairs</b>	144 - 147
<b>Sensory, De-escalation &amp; Seclusion</b>	148 - 157
<b>Bedroom</b>	158 - 171
<b>Lounge Cabinets</b>	172 - 184

**Teal is an approved NHS supplier under the following framework agreements:**

NHS Medical Healthcare Furniture and Equipment 2024/S 000-025534  
NHS Shared Business Services Design Furniture and Appliances 2 SBS10246  
NHS Scotland Furniture and Associated Services NP785/23

---

**Find out more:**

Tel: +44 (0) 1254 688210  
Email: [sales@teal.co.uk](mailto:sales@teal.co.uk)  
[www.teal.co.uk](http://www.teal.co.uk)

  Teal Furniture



# Complete Solutions Provider

We control every aspect of the process from product design, to manufacturing, logistics, installation and aftercare.



**Lifecare Brand**  
Products for challenging environments and mental health



**End-to-end Service**  
Major project delivery expertise; Including full Project Management for new build and refurbishment projects



**Therapeutic Environments**  
We help satisfy the rigours of clinical environments, promote patient dignity & contribute towards a therapeutic and healing patient environment



**UK Manufacturing**  
Products designed and manufactured in the UK at Teal's factory, tested to applicable standards



**Design**  
We work alongside designers of international repute to deliver innovative, design led solutions



**Delivery & Installation**  
Delivery using our own in-house fleet. Installation using a skilled, in-house experienced nationwide CSCS certified installation team



**Innovative Products**  
Inspirational new collections for the modern healthcare facility



**Sustainability**  
Strong sustainability credentials - all of our products are designed to be up to 100% recyclable



**Bespoke Solutions**  
Tailoring products to meet your exact requirements



**Aftercare & Support**  
Experienced Customer Service team with nationwide Service Support Team as part of our commitment to customer aftercare



**INDUSTRY  
LEADING  
WARRANTIES**

subject to standard  
Terms & Conditions  
([www.teal.co.uk](http://www.teal.co.uk)  
for details)

## Quality, Testing + Standards

We ensure quality at every stage of our process and are externally accredited to ISO 9001:2015. Our products are designed, manufactured, and installed to the highest levels of quality, durability and safety.

**In compliance with our ISO:9001 accreditation we consider quality at every step of the process, and with over 1m sq. ft. of manufacturing space and 1,200 employees, we have the infrastructure and personnel in place to support this.**

We have in-house design teams and we own the end-to-end manufacturing process.

We embed quality in every aspect of the process, including but not limited to:

- Use of High-Quality Materials
- Monitoring and Reporting the Quality of Goods
- Measuring Quality in our Supply Chain
- Measuring Quality in the Manufacturing Process
- Continuous improvement KPIs
- Quality Assurance checks throughout the process

Find out more about our Quality Control processes at [www.teal.co.uk](http://www.teal.co.uk)



# Design + Manufacture

Based in Lancashire and with its own manufacturing and operations across multiple sites, Teal is the healthcare division of The Senator Group – the largest manufacturer of commercial furniture and workplace solutions in the UK and the leading investor in Research, Development and Design.

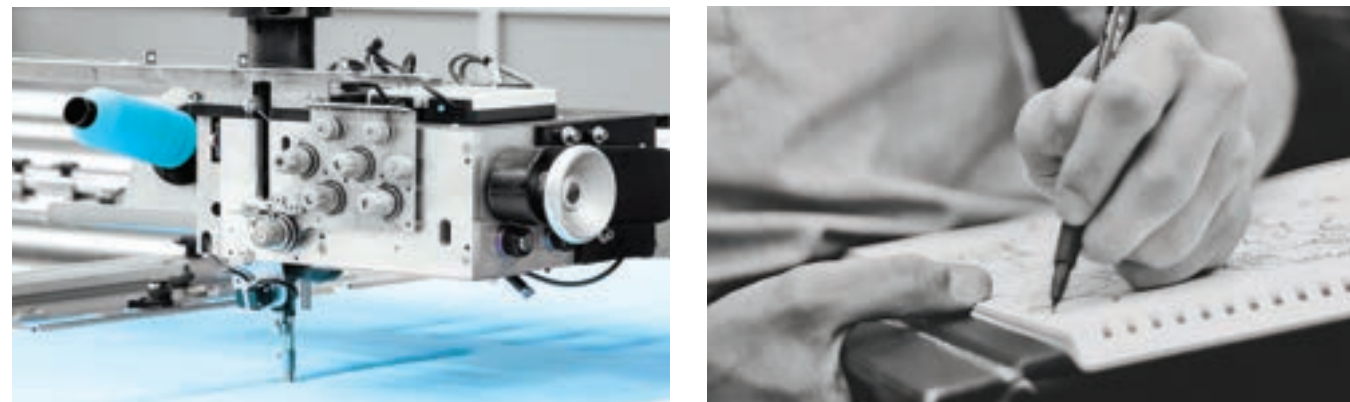
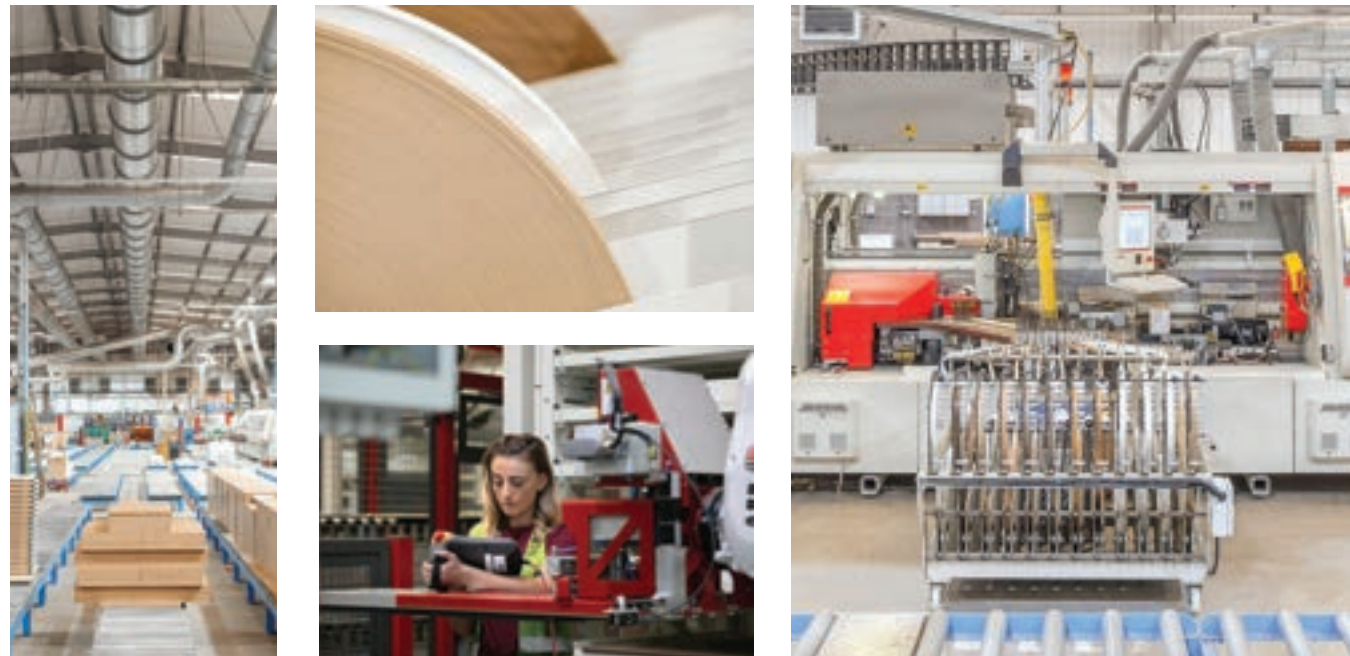

With facilities in Europe, the US and Middle East, Senator is a global brand. And even though Senator exports to over 70 countries, it remains an independent, family-owned business, controlling every aspect - from product design and innovation, to manufacturing, logistics, installation and aftercare.

A unique combination of state-of-the-art manufacturing technology together with traditional hand finishing expertise allows us to create beautifully crafted and detailed furniture and furnishing collections. As a true British manufacturer, we control every aspect of the process.

We design, we weld, we paint, we mould, we cut, we sew, ship and install.

# Our Pledge to Net Zero

The Senator Group UK Manufacturing and Logistics commits to reducing absolute Scope 1 and 2 greenhouse gas emissions by **50% by 2030** and by **100%** by 2040, from a 2019 baseline. We also commit to reducing Scope 3 GHG emissions to net zero by 2050.

We are proud to report that we have achieved a market-based reduction of 44.3% in Scope 1 and 2 emissions against our 2019 baseline\*.

Our GHG inventory is third party verified annually.

\*We have achieved a location-based reduction of 30.3% in scope 1 and 2.



Sustainable Partner to the NHS!

## Teal is a sustainable partner to the NHS...

Our own sustainability strategy is closely aligned to the NHS journey to net zero and we can therefore assist NHS Trusts and Health Boards to minimise their own environmental impact through our sustainable products and services.

# Ethics + Sustainability

## Our ESG Strategy

Our ESG commitments are near term, measurable and scalable, to ensure we deliver a consistent approach across the whole Group.

We have 46 objectives which allow us to focus our efforts and hold us accountable in delivering our long-term targets.

Our ESG Strategy is compartmentalised into three areas:

Designing with Intent, Reducing our Impacts and Building Better Lives.



This structure steers us in reviewing the environmental and social impact of our products and operations and is supported by our strong governance structure. The following sections summarise the progress we are making against each of our objectives and allow us to be transparent in reporting our progress against each annually.

# Our Progress Highlights

**74%**  
of our suppliers are UK based.



Our company cars have seen a  
**40%**  
reduction in emissions over the baseline.

Our water reclamation system has reduced our freshwater consumption by **85%**

85% of group waste was recycled.



All of our packaging was **100%** recyclable.

Our commercial fleet has achieved a 19% saving in CO2 emissions since 2009.



We have revised our ESG strategy, introducing three focus areas;

- Designing with intent
- Reducing our Impacts
- and
- Building Better Lives

We funded and ran two successful carbon footprint workshops for 10 of our local suppliers, in partnership with the Chamber Low Carbon.



We established our first Charity and Community Committee.



We won: **MEN business of the Year**, **Neocon Gold** in Collaborative Furniture for the Adapt Wall, and **BIBAs 'Manufacturer of the Year'**

**3%** of energy consumed across our UK manufacturing sites was from our solar panels.

Through our combined efforts, we raised and donated over **£250,000** for our chosen charitable causes within the last two years.

We engaged almost **1,000** employees in our sustainability roadshow and generated over **150** sustainability Bright Ideas.

Visit [www.teal.co.uk](http://www.teal.co.uk) for more information.

# Talking Recycling

## The role of waste management in the circular economy

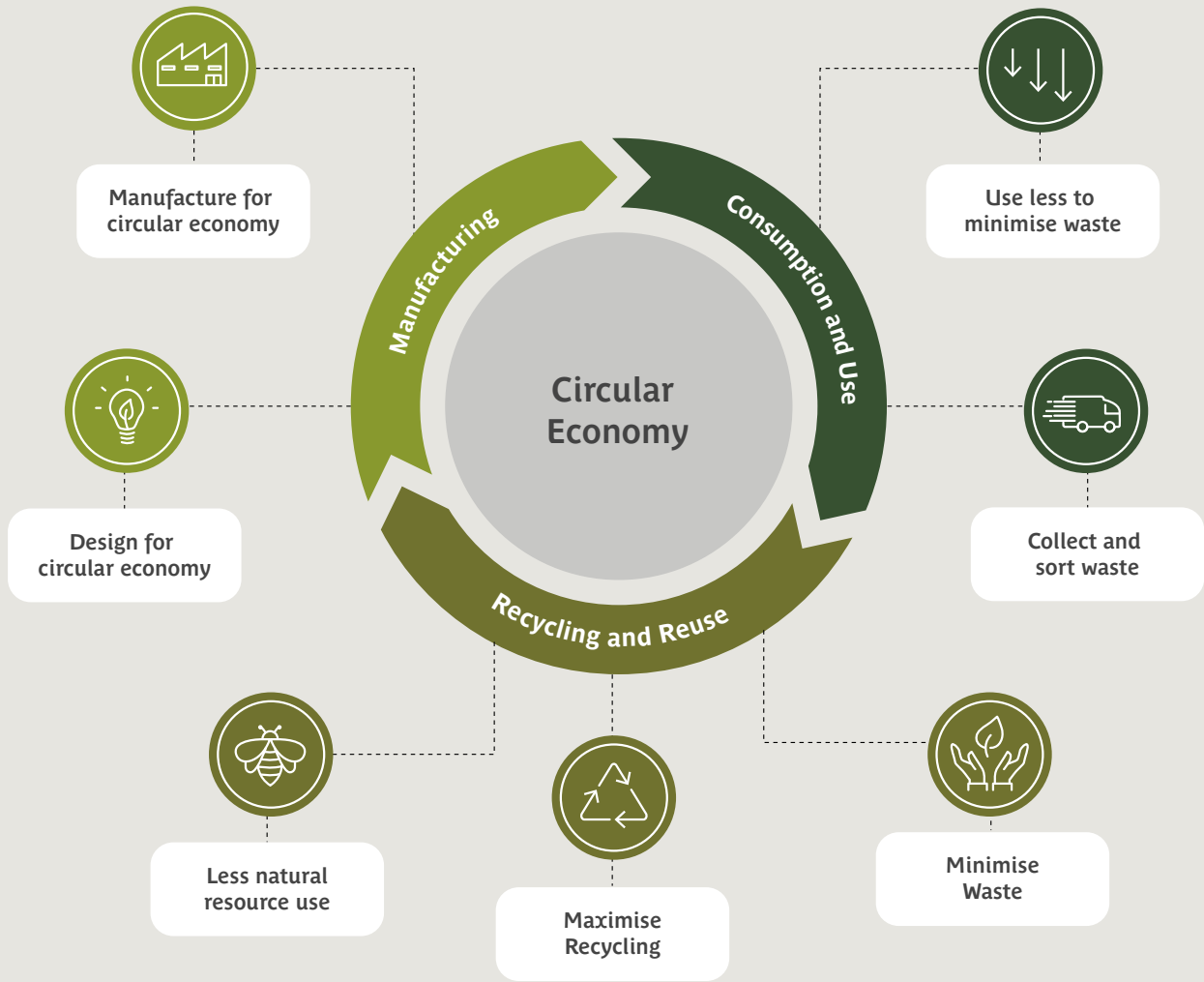

Waste minimisation and effective management is a key objective of our ESG strategy and the way we operate. Following the waste hierarchy, 'reduce, reuse, recycle' is a clear consumption mantra for the group. The emphasis is placed on reduction, be that energy, packaging and materials. Our employees are committed to waste management, whether that be in our offices, canteen or on the shop floor.

We regularly audit our waste management processes using our ISO 14001 management system to ensure best practice is being followed and to continually improve our techniques. In 2023, 87% of group operational waste was recycled.

Our packaging is 100% recyclable. We encourage recycling by utilising reverse logistics, back-loading our vehicles with post site installation packaging for processing at Sustain. Sustain offers a packaging recycling service which we call the White Bag Scheme.

This service is available for all to use, not just The Senator Group's clients, enabling everyone to responsibly recycle their packaging waste. The White Bag Scheme saw 627,750kg of packaging managed by Sustain last year. Much of our packaging is returned to us to use again, and last year we directly reused over 98,620 packaging items.

# Supporting a Closed Loop Circular Economy

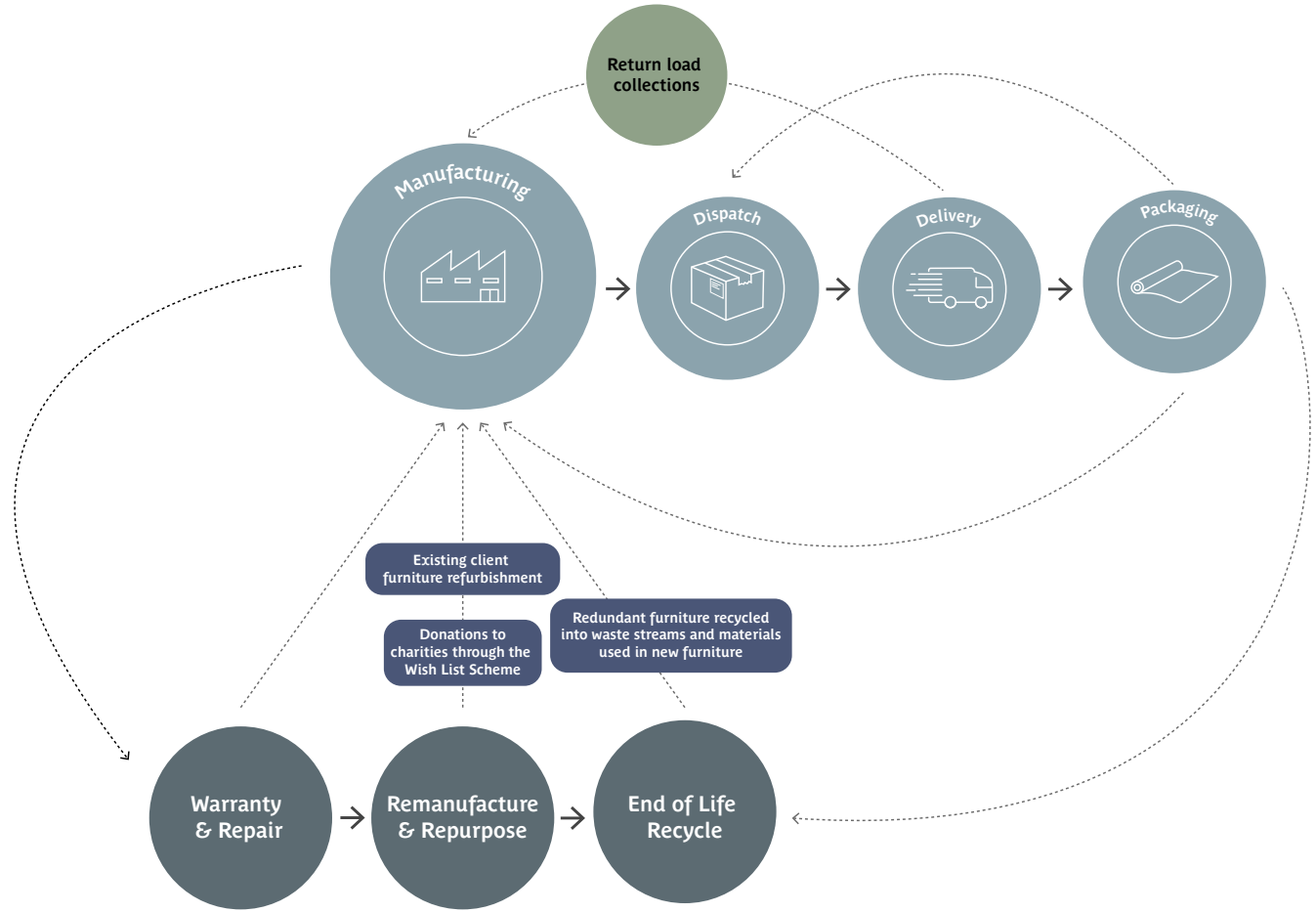

## We are working with our supply chain and waste contractors to understand opportunities to further pursue a circular economy model.

Manufacturing has a huge impact on our planet, and this is why we focus each year on how we can increase the circularity of our products, incorporating materials re-use throughout our design and manufacturing process. Our in-house Sustain recycling division is a unique benefit for us, enabling us to identify waste streams that can be reused within our supply chain.

Understanding the processing and onward journey of our waste enables us to highlight opportunities for these waste streams to be re-incorporated into our processes. When we start to think of designing a new product, we consider recycled and recyclable materials wherever possible; with Sustain down the road from our factories, we can control every stage of a products life. From using fewer virgin materials right at the very start of production, to recycling and reusing our old products part by part at the very end. Ultimately this supports us in reducing our demand on raw materials and reduces the embodied carbon of our products.

# Social + Value

The Senator Group are passionate about giving back to the communities in which we operate. To aid us in this, we have formed our own Charity & Community Committee.

## Local Engagement

We delivered over 1,200 hours of local school engagement, working in partnership with schools in our local area to deliver a structured local school engagement plan which targeted students of all ages and backgrounds.

This involved a range of:

- School visits / Interactive sessions
- Careers fairs
- Mock interviews
- Workplace safaris
- Tree planting initiatives

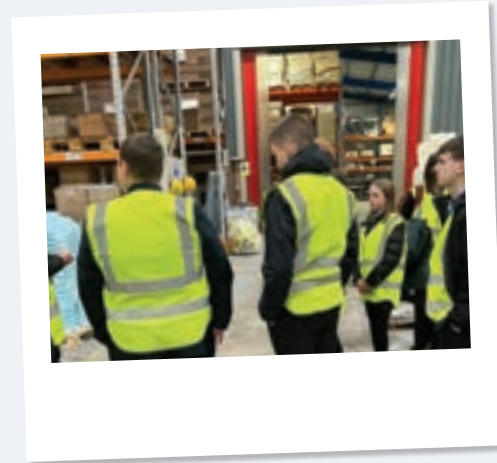

## St Bede's School Case Study

One such example is St Bede's, an 11-16 mixed Roman Catholic comprehensive school situated in the Lancashire.

St Bede's approached Teal as a local business provider to help provide experience of the workplace for its Year 11 Design Technology and Textile students.

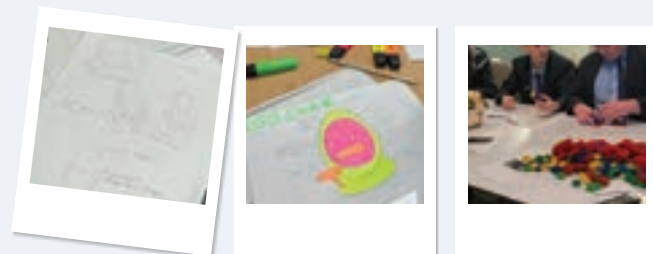

### Design task with students

St Bede's Year 11 Design Technology and Textile students spent a day on site at our Head Office and manufacturing site in Lower Darwen, with activities planned throughout the day including design and lean manufacturing tasks.

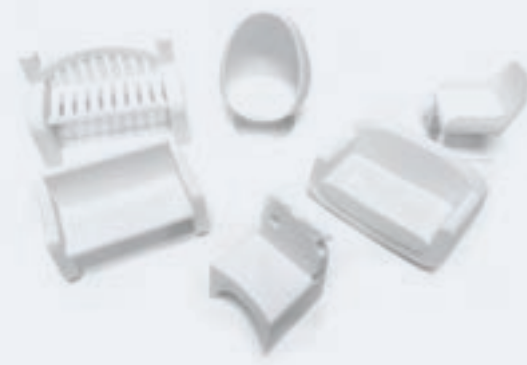

3D printed models designed by students of St Bede's

Led by our Programme Co-ordinator and the Teal Design & Development team we outlined a product brief (a piece of outdoor furniture suitable for use within a mental health environment), encouraging creativity and outside the box thinking. The final designs were 3D printed and illustrated in CAD.

## Tree planting

We joined forces with Ribble Rivers Trust to initiate a woodland planting project – we worked together over five days to plant a staggering 15,000 trees!

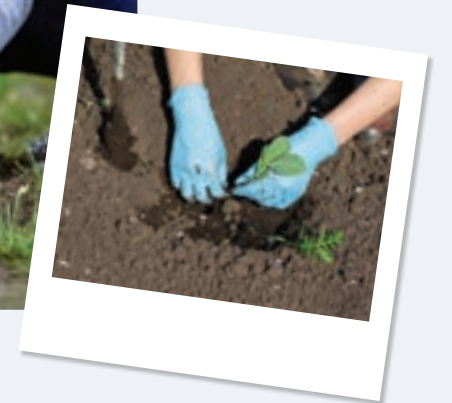

Season one of an ambitious two-phase planting project saw the planting of 15,000 trees across 30 acres of land.

Season two consisted of a further c.17,000 trees over 34 acres of land.

## Charity engagement

We are experienced in delivering social value commitments, both as part of our contractual obligations and as part of our wider company ESG Commitments.



As a business we've raised an incredible **£250k** in the last 2 years for charities, most of which was delivered in Lancashire, driving social and economic benefits.



ROKU® RENU is made from what was.  
Designed for what can be.

Crafted from 99% recycled materials and designed to be 99% recyclable at end of life, RENU represents a full-circle approach to design where nothing is wasted, everything has purpose, and renewal is built into every detail.



Created for spaces where people find renewal, progress and possibility. The furniture people live beside should reflect the same philosophy.

Shown with Panaz Nature, a soft plant based faux leather - 209 Wasabi



### We called it RENU

Made from over 99% recycled materials.

- + ROKU® RENU is created from a ground down polyethylene mix
- + Moulded products available in 99% recycled materials: ROKU® Tub chair, ROKU® table, ROKU® Keata, Button moulded Table and Button Stool
- + At least 99% recyclable at end of life
- + Only available in black finish

## Recycling Redundant Furniture

**Don't let your old furniture sit around.**  
Teal offer a comprehensive removal and recycling service for redundant furniture.

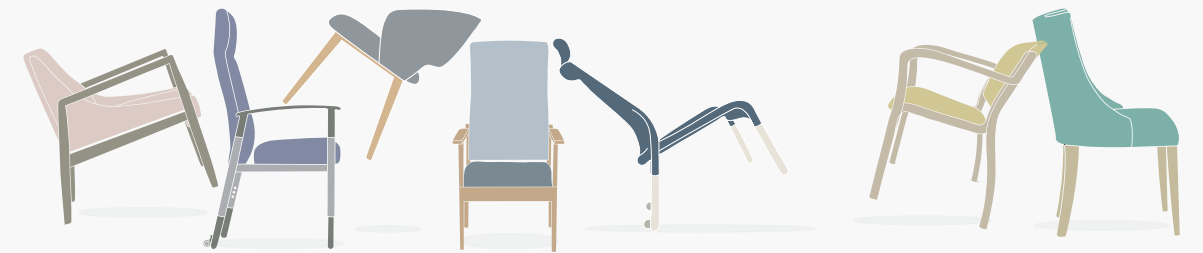

### We can collect your old furniture when we deliver new.

In 2009 we developed 'Sustain', our purpose-built 15,000ft<sup>2</sup> recycling unit in Lancashire. The £1.5million facility represents a significant investment in our sustainability commitment.

Any furniture classed as redundant by customers is processed at our Sustain facility. All materials are separated, segregated and then recycled.



Flexible, reliable, fast delivery service on an extensive range of best-selling healthcare furniture, in a select range of durable, healthcare appropriate fabrics.

Visit [www.teal.co.uk](http://www.teal.co.uk) to view the latest products available for QuickShip Express Delivery.

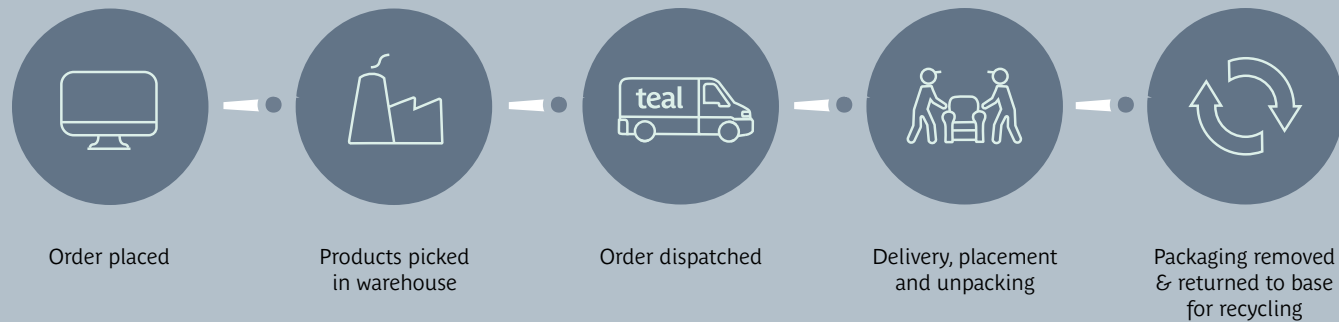

This includes delivery to a ground floor or room location. Products are unwrapped and packaging removed, ready to use.



Only the products / fabrics shown on our website are eligible for Express Delivery (UK mainland).

## Delivery + Installation

For specialist refurbishment or new build projects Teal bring together professional project management with qualified, experienced and skilled in-house installation teams to deliver complete, on-time and in budget.

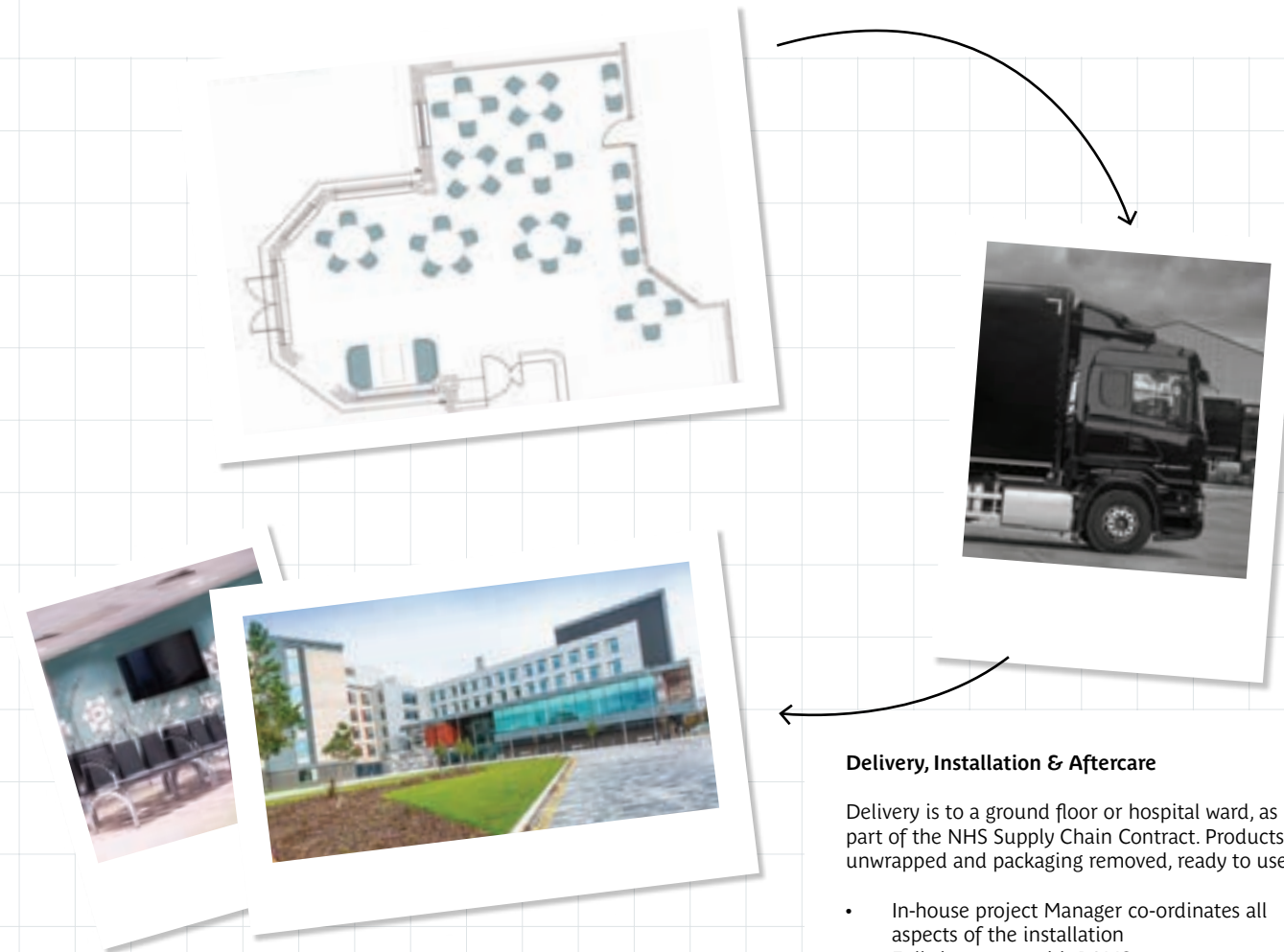

### Delivery, Installation & Aftercare

Delivery is to a ground floor or hospital ward, as part of the NHS Supply Chain Contract. Products are unwrapped and packaging removed, ready to use.

- In-house project Manager co-ordinates all aspects of the installation
- Full site survey with RAMS
- Installation in line with ISO9001
- Employees CSCS & DBS approved
- Nationwide Service Support Team as part of our commitment to customer aftercare

Visit [www.teal.co.uk](http://www.teal.co.uk) for more information.

# Teal have created a practical CAD resource to assist in the design process.

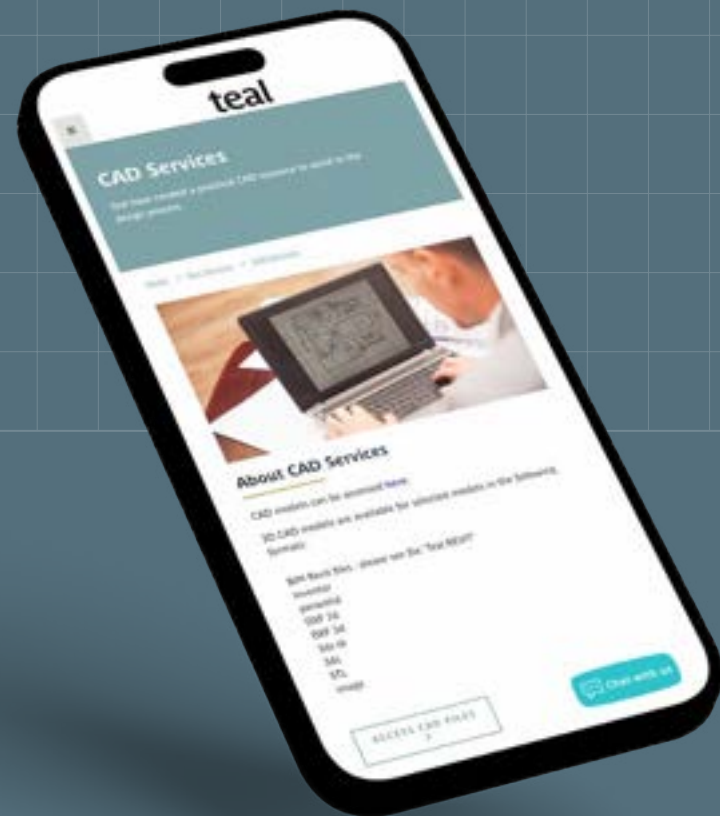

Please visit our website [www.teal.co.uk](http://www.teal.co.uk) to access all CAD models. Available in 2D, 3D and Revit.

## Discover our Medical Equipment & Healthcare Furniture Brochures online today at [www.teal.co.uk](http://www.teal.co.uk)!

### Medical Equipment

A range of Medical Equipment designed for clinical settings, including hospitals, clinics and care homes.

Designed for demanding high traffic healthcare environments our ranges include sterilisation furniture, transport trolleys, shelving & storage, operating room furniture, height-adjustable stools, waste & linen management, examination & consultation equipment and Eolis® modular trolleys - fully customisable, with multiple options available to meet clinical needs.



### Solutions for Healthcare

A range of premium quality Healthcare Furniture designed to meet the needs of infection control, tissue viability, manual handling, safety and comfort.

# Seren Lodge

Perinatal Unit

A state-of-the-art specialist mental health facility has opened in the heart of Chester, helping to deliver support for perinatal mothers, babies and their families from across Cheshire, Merseyside and North Wales.



Seren Lodge, operated by Cheshire and Wirral Partnership NHS Foundation Trust is a new specialist eight bedded unit designed to provide compassionate care for pregnant and postnatal women who are experiencing severe mental ill-health.

The light and space within the single storey building supports calmness and relaxation, while specialist furniture provided by Teal contributes towards a therapeutic and healing environment for women experiencing maternal mental health difficulties.

# Water Meadow View

Nestling within a 50-acre site that blends within the picturesque surrounding countryside lies Water Meadow View, a brand-new £32m mental health facility providing specialist support for adults with learning disabilities.

Designed by Gilling Dod Architects and operated by Lancashire & South Cumbria NHS Foundation Trust the 14-bedded unit in Whittingham, Preston benefits from specialist furniture for challenging environments, supplied throughout by Teal Lifecare.

The furniture choice reflects current best practice in mental health furniture design, helping to create safe and appropriate spaces, while helping staff to deliver patient centred care that places the service user at the heart of the process.



# Mossley Hill Hospital

Mental Health Facility, NHS

Consolidating services from across the city of Liverpool, a new inpatient unit has been built on the site of the old Mossley Hill Hospital, raising the standard of mental health care in the city and the wider Greater Merseyside region.



Commissioned by Mersey Care NHS Foundation Trust the modern, new, state-of-the-art mental health facility marks the end of traditional shared dormitory wards in the city, with single bedrooms and en-suite bathrooms to promote privacy and dignity.

Delivered by Graham Construction the new 80-bed facility features specialist mental health furniture supplied by Teal Lifecare and represents a step-change in the provision of mental health in the region.

# Humber Teaching

NHS Foundation Trust

A state-of-the-art in-patient facility has been unveiled in Hull, providing support for young people aged between 13 and 18 with severe and complex mental health issues.



# Product + Features

Look for these symbols throughout the brochure for a quick and easy way to check product specification, features and options.

- 

**Plus+ Complete upholstery option**  
Fully sealed upholstery to prevent concealment and for ease of cleaning



**Difficult to pick up**  
Flowing design means many products have been designed to make them difficult to pick up, with rounded corners and smooth lines
- 

**Weighting options**  
Products are available with concealed weighting options to limit misuse, increase stability and to maximise safety. (Note: Medium weighting = +15kg, Heavy weighting = +30kg)



**Security screws**  
Enhanced mental health (M) and Extreme environment (X) products are fitted with non-retractable security screws, no visible staples and no metal back tacking for added safety
- 

**Reduced Ligature**  
Products designed to minimise self-harm risks in mental health environments



**Glide foot**  
Strong, sturdy solid wood rail. Full contact with floor ensures robustness
- 

**Piano hinges**  
Strong, durable hinges with reduced ligature risk



**Lockable cabinet**  
Lockable storage for valuables & medication. Suiting option available
- 

**MFC construction**  
Robust core board, with a wide choice of wood effect finishes



**MDF construction**  
Enhanced density core board provides additional weight and strength
- 

**Mental Health Specification**  
Constructed for use in environments up to medium risk. See below for full details



**Extreme Environment Specification**  
Constructed for use in environments up to high risk. See below for full details

# Seating + Specification

Our two challenging behaviour seating specification options are identified by the M and X symbols, and can be found throughout this brochure.

## Mental Health Specification

Boarded seat platform and underside with non-retractable security fixings used throughout. Additional weighting options available

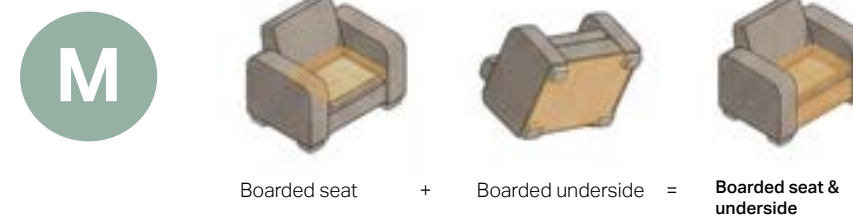

## Extreme Environment Specification

Fully boarded framework and underside with non-retractable security fixings throughout. Additional weighting options available



## Suitable Environments

**Low Risk**  
Suitable for reception, outpatient services, step-down & recovery.



**Low Risk**

**Low To Medium Risk**  
Reinforced products for environments where enhanced robust specification is required\*.



**Low to Medium Risk**

**Low To High Risk**  
Weighted, reinforced products for environments where intentional throwing and furniture damage is likely to occur.



**Low to High Risk**

\*Added weighting can make medium risk products suitable for a high risk environment. Please contact Teal for further details.

# Fabric & Finish Options

Teal source contract fabrics from market leading manufacturers.

Durable and resistant to abrasion, a range of fabrics are available to meet the specific demands of challenging environments.

Many are stain resistant, waterproof and have anti-microbial, anti-fungal properties to help reduce the risk of healthcare associated infections.

Standard fabric colour swatches can be viewed at [www.teal.co.uk](http://www.teal.co.uk)  
Fabric cards are available on request - please contact Teal customer services.



### Testing and Standards:

All fabrics and vinyls pass BS5852 Ignition Source 5 or higher and BS7176 Medium Hazard. Crib 7 options also available. All foams are Combustion Modified High Resilient fire retardant (CMHR).

### Customer's own fabrics:

Teal can upholster in a customer's own material. Please contact Customer Services prior to placing an order.



# Cleaning & Maintenance

Always follow the care and maintenance procedures specified by the fabric manufacturer.



### For general guidance:

- Clean and care for the fabric on a regular basis to maintain condition and appearance
- Most stains can be removed by wiping clean
- Wipe clean regularly with a damp cloth to remove dust particles and light soiling
- Remove spillages promptly (within 15 minutes) with an absorbent dry cloth
- E cloths are recommended for general cleaning of upholstery
- Information for general guidance only
- Always refer to manufacturer's cleaning instructions for details specific to the chosen fabric

# Wood Finish Options

## Chair Wood Stains

Standard wood stain finishes available on all solid timber chair legs and frames. Our furniture is manufactured in solid Beech or laminated Beech and is available in clear lacquer or a number of stained finishes, with Medicote™ anti-bacterial lacquer.

### Wood Stain Finishes:

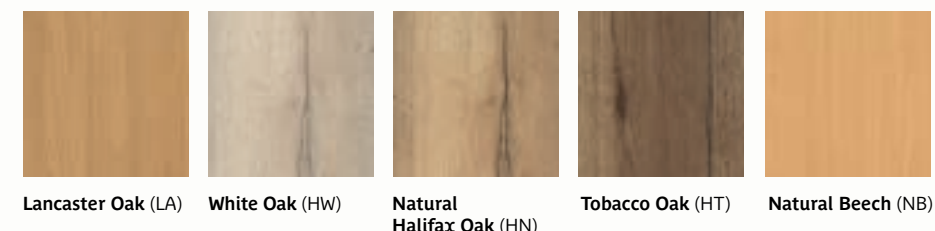

### Flat Finishes:

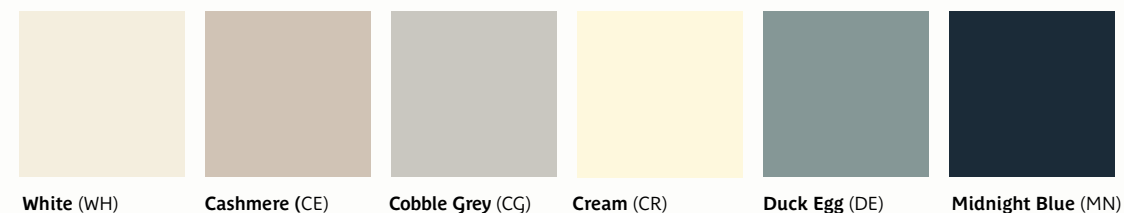

Stains can be matched to customer's own requirements. The original should be provided in this instance.

## Cabinet Finishes

MFC Furniture Finishes and Vinyl Wrap Available on 18mm MFC cabinet carcases, and as 18mm vinyl wrapped cabinets.

### Wood Grain Finishes:

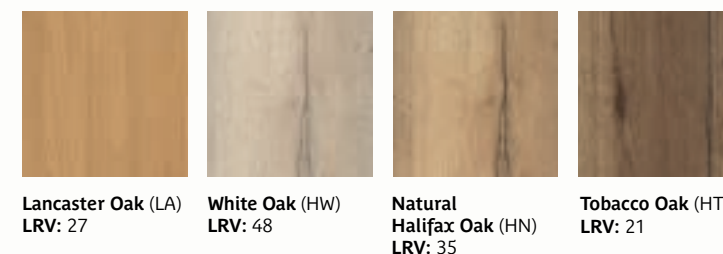

### Flat Finishes:

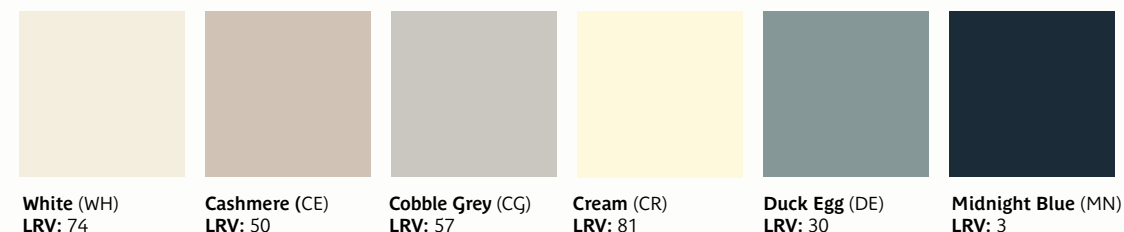

Colour Disclaimer: Printed images and digital images may appear differently to the final finish.

# Fabric+Matrix

Teal source contract fabrics from market leading manufacturers. Durable and resistant to abrasion, a range of fabrics are available to meet the specific demands of challenging environments. Many are stain resistant, waterproof and have anti-microbial, anti-fungal properties to help reduce the risk of healthcare associated infections.

Supplier	Range	Use: H = Hospital C = Care facility G = Gen reception	Contract Group	Type: F = fabric V = vinyl	Crib 5	Crib 7	Stain Resistant	Anti-Bacterial	Anti-Microbial	Water Resistant	Bleach Clean	Anti-Graffiti
Agua	Paint Pot (Faux Leather)	H	2	V	•		•	•	•	•	•	
Camira	Xtreme	G	2	F	•		•	•	•	•	•	
Panaz	Cadet Colors - Zest	H	2	V	•		•	•	•	•	•	
Panaz	Contemporary 4, Amathus, Etch, Trek, Venture	H	2	V	•		•	•	•	•	•	
Agua	Juno	C	3	F	•		•	•	•	•	•	
Agua	Linetta	C	3	F	•		•	•	•	•	•	
Agua	Lunar Aquarius, Lunar Scorpio	H	3	V	•		•	•	•	•	•	
Agua	Parody Linen	H	3	V	•		•	•	•	•	•	•
Agua	Taurus	H	3	V	•		•	•	•	•	•	
Chieftain	Just Colour & Just Patterns	H	3	V	•		•	•	•	•	•	
Dartex	Pressure Care 4 x Stretch	H	3	V	•		•	•	•	•	•	
Panaz	Aston (Faux Leather)	H	3	V	•		•	•	•	•	•	
Panaz	Brookland	H	3	V	•		•	•	•	•	•	
Panaz	Highland	C	3	F	•		•	•	•	•	•	
Panaz	Tweedy	H	3	V	•		•	•	•	•	•	
Panaz	Alba	C	3+	F	•		•	•	•	•	•	
Agua	Argentex	C	3+	V	•		•	•	•	•	•	
Agua	Entwine	C	3+	V	•		•	•	•	•	•	
Agua	Fleck	H	3+	V	•		•	•	•	•	•	
Agua	Nova	C	3+	F	•		•	•	•	•	•	
Agua	Primeira	C	3+	F	•		•	•	•	•	•	
Agua	Sark	C	3+	F	•		•	•	•	•	•	
Agua	Tones	C	3+	F	•		•	•	•	•	•	
Boyriven	Enduralex with Forbid anti graffiti	H	3+	V	•		•	•	•	•	•	•
Camira	Mainline Plus	G	3+	F	•		•	•	•	•	•	
Camira	Vita	H	3+	V	•		•	•	•	•	•	
I Liv	Lismore	C	3+	V	•		•	•	•	•	•	
I Liv	Nevis	H	3+	V	•		•	•	•	•	•	
I Liv	Q1898 Printed (Base Cloth)	C	3+	F	•		•	•	•	•	•	
I Liv	Q2099 Printed (Base Cloth)	C	3+	F	•		•	•	•	•	•	
Panaz	Cadet Soft Touch Pro (PVC)	H/C	3+	V	•		•	•	•	•	•	
Panaz	Eve	C	3+	F	•		•	•	•	•	•	
Panaz	Haven (Outdoor/Indoor)	C	3+	V	•		•	•	•	•	•	
Panaz	Highland Matte Stretch	C	3+	F	•		•	•	•	•	•	
Panaz	Highland Printed	C	3+	F	•		•	•	•	•	•	
Panaz	Luxe Performance Velvet	C	3+	F	•		•	•	•	•	•	
Panaz	Vyflex Plus Stretch	H	3+	V	•		•	•	•	•	•	
Skopos	Chamonix - Orelle & Slalom	C	3+	F	•		•	•	•	•	•	
Skopos	Moritz - Casper & Orelle	C	3+	F	•		•	•	•	•	•	
Spradling	Silvertex CR5	H	3+	V	•		•	•	•	•	•	
Spradling	Valencia CR5	H	3+	V	•		•	•	•	•	•	
Vescom	Creek	H	3+	V	•		•	•	•	•	•	
Vescom	Furka +	H	3+	V	•		•	•	•	•	•	
Vescom	Jemo	H	3+	V	•		•	•	•	•	•	
Vescom	Arrow, Cyprus, Dalma, Malta, Scott	H	3+	V	•		•	•	•	•	•	
Vescom	Scott, Arrow, Dalma, Cyprus, Malta	H	3+	V	•		•	•	•	•	•	

See latest fabric matrix at [www.teal.co.uk](http://www.teal.co.uk)

Supplier	Range	Use: H = Hospital C = Care facility G = Gen reception	Contract Group	Type: F = fabric V = vinyl	Crib 5	Crib 7	Stain Resistant	Anti-Bacterial	Anti-Microbial	Water Resistant	Bleach Clean	Anti-Graffiti
Agua	Boucle	C	4	F	•		•	•	•	•	•	
Agua	Eden	C	4	F	•		•	•	•	•	•	
Agua	The 7 Collection (Crib 7)	H	4	V		•	•	•	•	•	•	
Camira	Halcyon - Aspen, Blossom, Cedar	C	4	F	•		•	•	•	•	•	
Panaz	Luxe Velvet printed	C	4	F	•		•	•	•	•	•	
Panaz	Woolton Plus printed	C	4	F	•		•	•	•	•	•	
Skopos	Chamonix Collection - Marmotte	C	4	F	•		•	•	•	•	•	
Skopos	Moritz Collection - Bernina	C	4	F	•		•	•	•	•	•	
Skopos	Herriot Collection - Bennet, Hughes, Phinn, Priestley	C	4	F	•		•	•	•	•	•	
Skopos	Chamonix - Cresta, Luge		4	F	•		•	•	•	•	•	
Spradling	Avantgarde	H	4	V		•	•	•	•	•	•	
Lindhurst	Sileather Premier & Original	H	5	V	•		•	•	•	•	•	•
Sunbury	Stylecare 4 range, Fleming, Jemison,	C	5	F	•		•	•	•	•	•	
Ambla	Berkshire / Richmond, Munro, Wild Heather, Tinto	H	POA	V	•		•	•	•	•	•	
Sunbury	Stylecare 4 Barton	C	POA	F	•		•	•	•	•	•	
Ultrafabrics	Ultraleathers	G	POA	V	•							
Yarwood	Style Leather	G	POA	L	•							

Please contact Teal Customer Services for help in the selection of a suitable fabric for your environment.

### The following fabrics are suitable for fully sealed complete upholstery:

We are continually testing fabrics for suitability for complete upholstery.

Please contact Customer Services for the latest list.

Supplier	Range	Use: H = Hospital C = Care facility G = Gen reception	Contract Group	Type: F = fabric V = vinyl	Crib 5	Crib 7	Stain Resistant	Anti-Bacterial	Anti-Microbial	Water Resistant	Bleach Clean	Anti-Graffiti
Panaz	Cadet Zest	H	TP2	V	•		•	•	•	•	•	
Chieftain	Just Colour	H	TP3	V	•		•	•	•	•	•	
Panaz	Aston	H	TP3	V	•		•	•	•	•	•	
Panaz	Brookland	H	TP3	V	•		•	•	•	•	•	
Panaz	Riva	H	TP3	F	•		•	•	•	•	•	
Panaz	Tweedy	H	TP3	V	•		•	•	•	•	•	
Panaz	Alba	C	TP3+	F	•		•	•	•	•	•	
Panaz	Haven (Outdoor/Indoor)	C	TP3+	V	•		•	•	•	•	•	
Panaz	Vintage		TP3+	V	•		•	•	•	•	•	
Vescom	Furka	H	TP3+	V	•		•	•	•	•	•	
Vescom	Jemo	H	TP3+	V	•		•	•	•	•	•	
Agua	Fleck	H	TP3+	V	•		•	•	•	•	•	
Panaz	Vintage		TP3+	V	•		•	•	•	•	•	
Panaz	Cadet Zest Crib 7	H	TP4	V	•	•	•	•	•	•	•	
Chieftain	Protect 7	C	TP5	V	•	•	•	•	•	•	•	
Lindhurst	Sileather Premier & Original	H	TP5	V	•		•	•	•	•	•	•
Lindhurst	Theory		TP5	V	•		•	•	•	•	•	•

Please contact Teal Customer Services for help in the selection of a suitable fabric for your environment.

See latest fabric matrix at [www.teal.co.uk](http://www.teal.co.uk)

**Designed for the most demanding challenging environments, the Roku® range delivers exceptional durability through seamless rotationally moulded construction and high-impact performance.**

Its one-piece design removes seams and joins to support enhanced strength, reduced maintenance and improved infection control, while hollow internal sections allow additional weighting to help minimise movement within high-risk settings.



# Roku® Family



**Multiple finish options available**  
see pages 30-33 for further information



## Roku® Family

**In challenging environments, colour selection forms an important part of the wider environmental strategy, contributing to atmosphere, spatial orientation, and sensory experience.**









The Roku® palette has been developed to deliver a refined balance of calming tones, functional contrast and durable finishes, supporting environments that are both therapeutic and practical for everyday use.

### Standard Features

- Smooth, high impact polyethylene, rotationally moulded for maximum durability
- Stain-resistant, seamless and easy to clean for longevity and easy maintenance
- Smooth, round profile edges ensure enhanced safety and security
- Roku® features durable polyethylene construction with integral UV stabiliser to reduce colour fade in outdoor locations



## Colour options

(Selected products only):

 Iron Gate*	 Cornflower Blue	 Heather Purple
 Warm Sand	 Sage Green	 Misty Blue
 Slate Green	 Chateau Grey	

\*Iron Gate finish is standard on selected products: Roku® Emi, Roku® Kimi Chairs, Roku® Oyster Tables, Roku® Marna Chairs, Roku® Rocker, Roku® Bedroom Furniture - RKBD01, RKBD02, RKBS01, RKWU01, RKWU02, RKDK01. Minimum order quantities apply on non-standard colours.

Additional colour options (selected products only):

 Fresh Papaya	 Marine Teal	 Roku® Renu
--	---	--

All of the 11 colours options shown are available on Roku® Keata, Roku® Tub, Roku® Table, Button Table & Stool (no MOQ applies).

# Roku® Tubs & Tables

Roku's distinctive six-sided form combines a modern aesthetic with robust construction. Its versatile design supports safe, durable use across dining, bedroom, reception and outdoor spaces.



**TSRK21 Roku®**  
Moulded Tub Chair



**TSRK22 Roku®**  
Moulded Tub Chair  
Upholstered Seat



**TSRK23 Roku®**  
Upholstered Tub Chair



**TSRK25 Roku®**  
Moulded Tub Chair  
Upholstered Seat & Back



**TARK21 Roku®**  
Moulded Table



**TSRK24 Roku®**  
Upholstered Bench Seat



“Roku® is difficult to manoeuvre, with ligature free design and no protruding corners or areas for concealment.”

- Ben Graffton

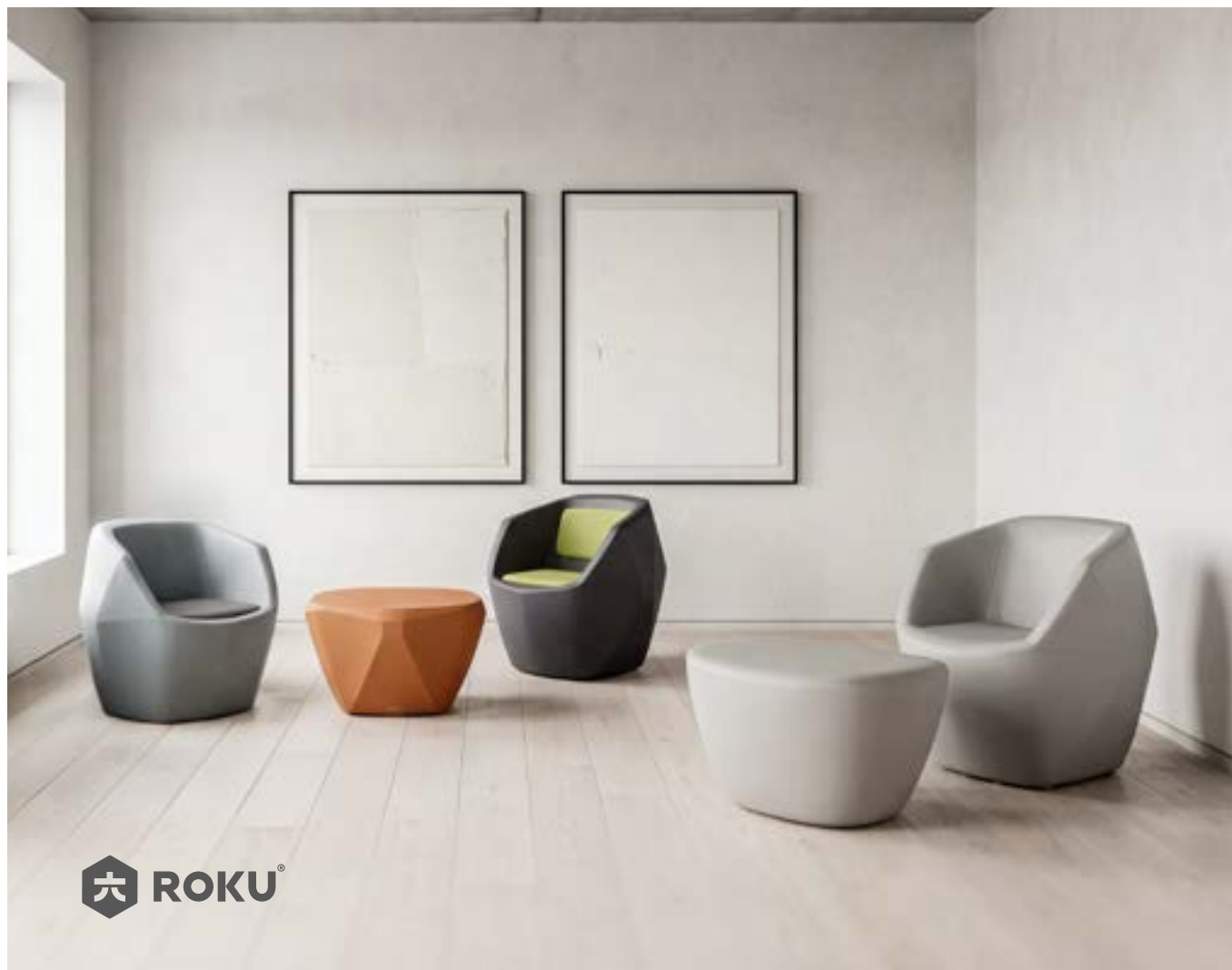

**Standard Features**

- Standard weight to limit misuse and maximise safety
- Ergonomically designed back & armrest
- Durable one piece rotationally moulded polyethylene provides excellent impact strength & durability
- Sealed, six-sided shape offers complete reduced ligature and concealment free design

**Optional Features**

- Floor fixing base plate option
- Finish options available (see page 37)
- Additional weighting options available (see page 28)
- Upholstered Roku® available in a wide range of fabrics (see pages 32-33)
- 100% recyclable material (Roku® Renu See page 18)

Code	Product	H	W	D	AH	SH	SW	SD	WT
TSRK21	Roku® Tub Chair; Non-Upholstered	805	775	795	700	435	465	475	30
TSRK22	Roku® Tub Chair; Upholstered Seat Pad	805	775	795	700	460	465	475	31
TSRK23	Roku® Tub Chair; Fully Upholstered	805	775	795	700	460	465	475	34
TSRK24	Roku® Bench Seat; Fully Upholstered	490	795	815	700	-	-	-	34
TSRK25	Roku® Tub Chair; Upholstered Seat & Back Pad	805	775	795	700	460	465	475	32
TARK21	Roku® Table	480	775	795	-	-	-	-	30

# Roku® Keata



Roku® Keata combines a compact footprint with the robust design of the Roku® range making it ideal for spaces where flexibility and movement matter.



## Standard Features

- Compact footprint ensures chair easily passes through a doorway or tucks under a desk or dining table
- Durable one piece rotationally moulded polyethylene provides excellent impact strength & durability



## Optional Features

- Roku® colour finishes (see page 37)
- A wide range of fabrics for seat & back pad (see pages 32-33)
- Additional weighting options available (see page 28)
- 100% recyclable material (Roku® Renu See page 18)

**DCRK01 Roku® Keata**  
Moulded Chair

**DCRK02 Roku® Keata**  
Moulded Chair Upholstered Seat

**DCRK03 Roku® Keata**  
Moulded Chair  
Upholstered Back Pad

**DCRK04 Roku® Keata**  
Moulded Chair  
Upholstered Seat & Back Pad

Code	Product	H	W	D	AH	SH	SW	SD	WT
All Models	Roku® Keata Side Chairs	810	510	615	-	450	490	450	20



# Roku® Rocker



Building on the robust safety-focused design of the Roku® range, Roku® Rocker introduces gentle movement designed to support comfort, relaxation and sensory wellbeing.



**RKRC01 Roku® Rocker**  
Rocking Chair



**RKRC02 Roku® Rocker**  
Rocker Chair with seat pad

*Designed to integrate seamlessly across lounge, breakout and sensory spaces, Roku Rocker supports therapeutic comfort and relaxation.*



Code	Product	H	W	D	AH	SH	SW	SD	WT
RKRC01	Roku® Rocker	838	762	838	622	445	610	470	20.5
RKRC02	Roku® Rocker with Seat Pad	838	762	838	622	445	610	470	20.5

**Standard Features**

- Gentle rocking motion offers a soothing experience that supports emotional regulation & relaxation
- Ergonomically designed for comfort
- Smooth, round profile edges ensure enhanced safety and security
- Extremely robust, heavy duty construction

**Optional Features**

- Contract fabric options on seat pad model (see pages 32-33)
- Additional weighting options available (see page 28)

# Roku® Marna



## Standard Features

- Stain-resistant, seamless and easy to clean for longevity and easy maintenance
- Ergonomically designed for comfort
- Smooth, round profile edges ensure enhanced safety and security
- Extremely robust, heavy duty construction
- Models with upholstered seat pads (recommended for supervised spaces)

## Optional Features

- Non removable nylon glides
- Floor fixing options
- Weighting options (see page 28)
- Contract fabric options for seat pad option (see pages 32-33)



A robust contemporary seating collection with soft organic forms, unique wide seat option, ligature reducing, concealment free design and a soft colour palette combining a safer environment and calming aesthetic.



**RKMN01 Roku® Marna**  
Lounge Chair



**RKMN02 Roku® Marna**  
Lounge Chair  
with seat pad



**RKMN03 Roku® Marna**  
Wide Lounge Chair



**RKMN04 Roku® Marna**  
Wide Lounge Chair  
with seat pad

Code	Product	H	W	D	AH	SH	SW	SD	WT
RKMN01	Roku® Marna Lounge Chair	840	765	790	622.	445	610	470	19
RKMN02	Roku® Marna Lounge Chair with Seat Pads	840	765	790	622.	445	610	470	21
RKMN03	Roku® Marna Wide Lounge Chair	840	940	790	622.	445	790	470	24
RKMN04	Roku® Marna Wide Lounge Chair with Seat Pads	840	765	790	622.	445	610	470	26

# Roku® Oyster



### Standard Features

- Extremely robust, heavy duty construction
- Security fixings throughout
- Pick-resistant polyurethane edge profile (RKTA01 + 02 only)
- Weighted as standard

### Optional Features

- Plastic base finishes
- Laminate top finishes
- KYDEX® top finishes
- Floor fixing brackets

### Top Finishes:

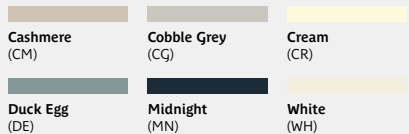
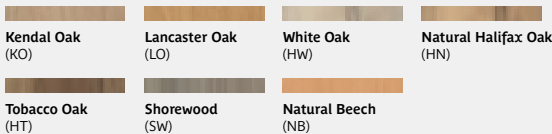

### Top Finishes (RKTA01 & RKTA02):

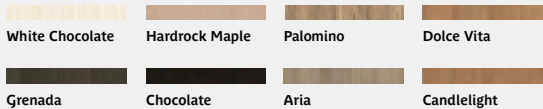

### KYDEX® Finishes:

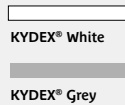

### Laminate Top with Moulded Edge:



**RKTA01 Roku® Oyster**  
1065mm Table  
H: 745mm  
Weight: 71Kg



**RKTA02 Roku® Oyster**  
1220mm Table  
H: 745mm  
Weight: 78Kg

Roku® Oyster combines strength, stability and clean design, supporting safe, durable and easy-to-maintain dining and communal spaces.

### Laminate Top & KYDEX® Tops:



**RKTA03 Roku® Oyster**  
900mm Table  
H: 745mm



**RKMN04 Roku® Oyster**  
1100mm Table  
H: 745mm

### Soft Square Top:



**RKTA05 Roku® Oyster**  
900mm Table  
H: 745mm



**RKMN06 Roku® Oyster**  
1100mm Table  
H: 745mm



**RKMN07 Roku® Oyster**  
2000mm x 1200mm Table  
H: 745mm

### Outdoor:



**RKTA08 Roku® Oyster**  
Outdoor  
900mm Table  
H: 745mm



**RKTA09 Roku® Oyster**  
Outdoor  
1100mm Table  
H: 745mm

# Roku® Bedroom Furniture

Roku® Bedroom is an extremely durable one-piece rotationally moulded furniture collection with a distinctive contemporary aesthetic developed for the most demanding secure and challenging environments.



Its seamless construction supports reduced concealment opportunities, reduced ligature detailing and vandal-resistant everyday use, while optional internal weighting provides additional strength and stability.



**RokBS01 Roku®**  
Bedside cabinet



**RokWU01 Roku®**  
Two shelf wall mount unit



**RokWU02 Roku®**  
Three shelf wall mount unit



**RokOT01 Roku®**  
Occasional table



**RokST01 Roku®**  
Stool



**RokWR01 Roku®**  
Four shelf wardrobe unit



**RokCH02 Roku® Kimi**  
Bedroom Chair



**RokCH03 Roku® Kimi**  
Bedroom Chair with seat & back pads



**RokDK01 Roku®**  
Desk



### Standard Features

- Bed and bedside cabinet sides fit flush to walls
- Smooth, round profile edges ensure enhanced safety and security

### Optional Features

- Floor fixing brackets
- Glides on selected models
- Finish options (see page 37)

Code	Product	H	W	D	AH	SH	SW	SD	WT
RKBS01	Roku® Bedside Unit	595	510	460	-	-	-	-	12
RKWU01	Roku® Wall Mounted 2 Shelf Unit	560	740	355	-	-	-	-	11
RKWU02	Roku® Wall Mounted 3 Shelf Unit	1295	740	355	-	-	-	-	23
RKOT01	Roku® Occasional Table	419	609	609	-	-	-	-	9.5
RKST01	Roku® Stool	482	457	457	-	482	-	-	5.5
RKWR01	Roku® Four Shelf Wardrobe Unit	1860	711	584	700	-	-	-	43
RKCH02	Roku® Side Chair	877	605	700	-	485	605	470	15
RKCH03	Roku® Side Chair; Upholstered Seat & Back Pad	877	605	700	-	500	605	470	15
RKCH04	Roku® Side Chair; Upholstered Seat Pad	877	605	700	-	500	605	470	15
RKDK01	Roku® Roku Desk	736	920	848	-	-	-	-	19

# Roku® Roto-moulded Bed



The Roku® Roto-moulded bed combines high-impact polyethylene construction with a seamless, fully enclosed design that delivers durability, hygiene performance and long-term reliability.



**Standard Features**

- Integrated mattress retainers for stability
- Surface grooves to support fluid management and cleaning
- Stain-resistant and easy to clean for infection management
- Optional underbed storage to maximise space (**RKBD02**)
- Single side bed storage can be positioned left or right facing

**Optional Features**

- Floor fixing brackets
- Finish options (see page 37)

Code	Product	H	W	D	AH	SH	SW	SD	WT
RKBD01	Roku® Single Bed	510	2120	1005	-	-	-	-	67
RKBD02	Roku® Single Bed; Side Storage	510	2120	1005	-	-	-	-	71
RKMT01	Roku® C5 PU Welded Mattress	200	915	2000	-	-	-	-	-
RKMT02	Roku® C5 PU Welded Mattress with Pillow	200	915	2000	-	-	-	-	-
RKMT03	Roku® C5 Anti-vandal PVC Mattress	200	915	2000	-	-	-	-	-
RKMT04	Roku® C5 Anti-vandal PVC Mattress with Pillow	200	915	2000	-	-	-	-	-

It's robust form smooth rounded edges and integrated detailing help support safer environments in higher security settings.

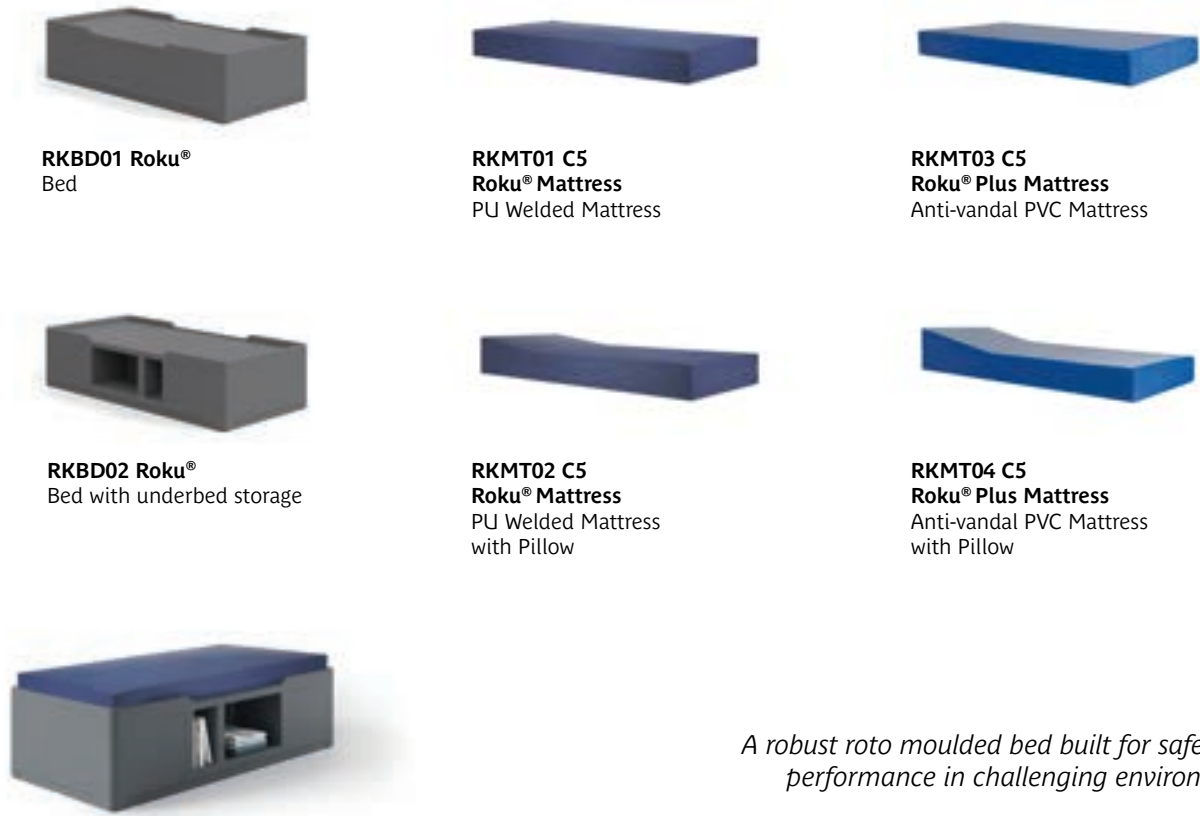

*A robust roto moulded bed built for safety and performance in challenging environments.*

**Features:**

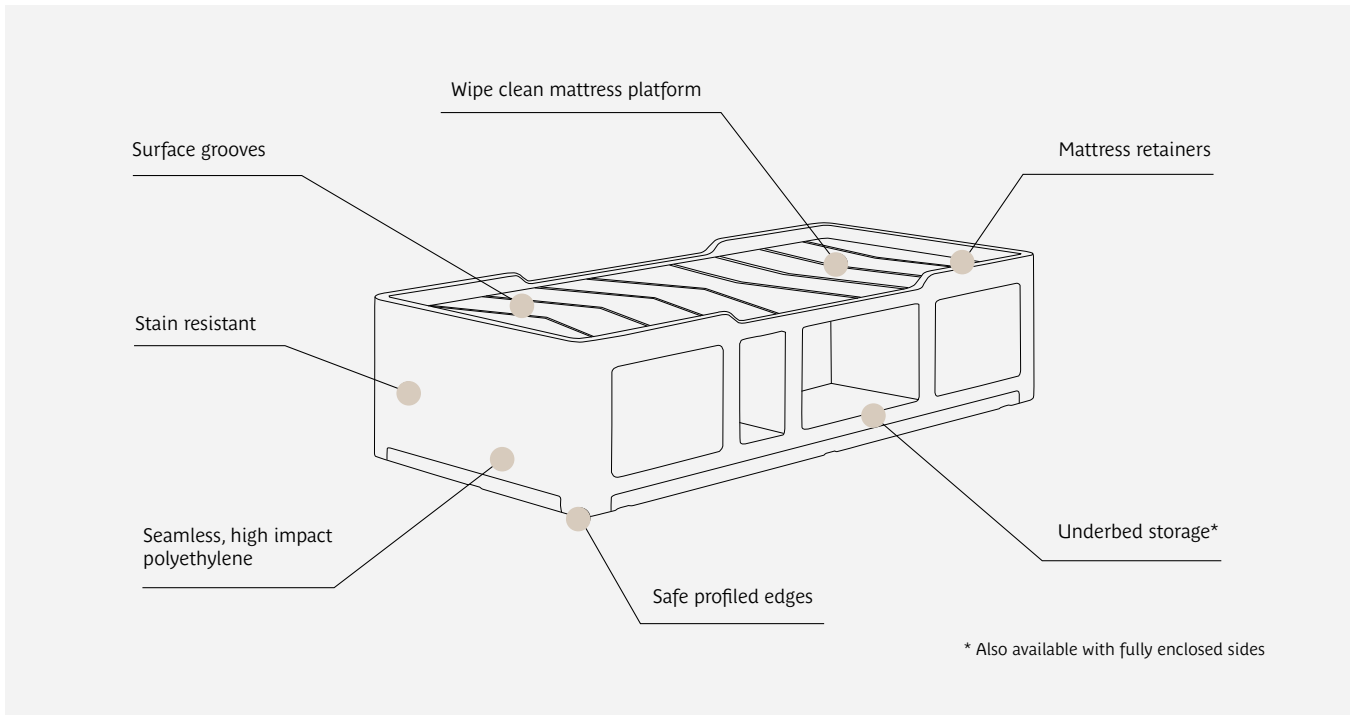

\* Also available with fully enclosed sides

# Roku® Planter / Bench / Storage



Roku® integrates seating, planting and storage within one flexible, robust furniture system. Supporting calmer spaces and wellbeing through more considered layouts and integrated natural elements.



Roku® Bench



Roku® Planter

Roku® Storage allows functionality to be integrated seamlessly into the environment while maintaining a clean, architectural appearance.

Designed as part of the wider Roku® system, the storage solution enables designers to create spaces that feel intentional, uncluttered and cohesive. Its seamless construction and multifunctional design approach support environments that prioritise both practicality and atmosphere.



Roku® Storage

The new Roku® range offers a specification-led furniture system designed to bring greater flexibility, functionality and intention to modern healthcare and challenging environments.

Created to adapt at the point of design, Roku® allows spaces to be shaped around the needs of the environment, whether through seating, integrated planting or storage.



## Standard Features

- Stain resistant, seamless, easy clean surfaces
- Roku® features durable polyethylene construction with integral UV stabiliser to reduce colour fade in outdoor locations

## Optional Features

- Floor fixing options
- Additional weighting options available (see page 28)

Code	Product	H	W	D	AH	SH	SW	SD	WT
RKPL01	Roku® Planter	475	1300	600	-	-	-	-	29.5
RKBE01	Roku® Bench	475	1300	600	-	475	1300	600	29.5
RKSU01	Roku® Storage	475	1300	600	-	-	-	-	29.5



*Bench can be floor fixed.  
Storage can be wall fixed.  
Multiple weighting options available.*

Roku® features durable polyethylene construction with integral UV stabiliser to reduce colour fade in outdoor locations.

# Roku® Outdoor



## Roku® Planter

The Roku® Planter supports the creation of calmer, more restorative environments by introducing natural elements in a controlled and durable format.

Designed to soften spaces both visually and emotionally, Roku® helps transform interiors from purely functional settings into environments that feel more welcoming and supportive of wellbeing.

## Roku® Bench

Its rotationally moulded one-piece construction removes seams and joins, creating a robust and highly durable solution suited to demanding environments. The result is a bench that balances strength with simplicity bringing a softer, design-led aesthetic to spaces.



Roku® Bench



Roku® Planter



Roku® has been developed to support calmer therapeutic environments through robust contemporary furniture designed for both indoor and outdoor use.



DCRK01 Roku® Keata Side Chair



TARK21 Roku® Table



TSRK27 Roku® Tub Chair Outdoor Drain Holes



RKCH01 Roku® Emi Side Chair Only available in selected colours See Roku® finish options



RKCH02 Roku® Kimi Side Chair Only available in selected colours See Roku® finish options



RKTA08 Oyster 900mm Diameter Table Only available in selected colours See Roku® finish options



RKMN01 Roku® Marna Armchair



RKMN03 Roku® Marna Wide Armchair



RKTA09 Oyster 1100mm Diameter Table Only available in selected colours See Roku® finish options

### Standard Features

- Stain resistant, seamless, easy clean surfaces
- Roku® features durable polyethylene construction with integral UV stabiliser to reduce colour fade in outdoor locations

### Optional Features

- Floor fixing options available (With the exception of Roku® Emi)
- Additional weighting options available (see page 28)



Optional weighting and drainage solutions support stability and practical everyday use, while UV-stabilised materials help maintain appearance and reduce colour fade.



# Button



With its compact form, the Button oval table and multi-purpose stool have been designed to exploit the possibilities offered by rotationally moulded plastics, both indoors and outdoors.



**RKBU01 Button**  
Oval Dining Table

H:730mm  
W: 985 mm  
Weight: 15kg



**RKBU02 Button**  
Stool

H: 480mm W: 480mm  
D:360mm SH:480mm  
Weight: 5kg



## Standard Features

- Smooth, high impact polyethylene, moulded for maximum durability
- Stain-resistant, seamless and easy to clean for longevity and easy maintenance
- Smooth, round profile edges ensure enhanced safety and security

## Optional Features

- Finish options available (see page 37)
- Floor fixing options
- Additional weighting options available (see page 28)



Smooth rounded forms and a distinctive contemporary finish give the Button range a softer modern aesthetic, while easy-clean surfaces and optional weighting solutions support safer, more stable everyday use.

This collection combines robust construction, contemporary styling and flexible configurations across dining and communal settings. From high-spec weighted tables and secure fixing options to supportive seating and wheelchair-friendly designs, each range has been developed to support safer, more welcoming environments.



# Dining+ Coffee Tables



Multiple finish options available  
see pages 30-33 for further information

# Coast Dining & Coffee Tables

Combining bold contemporary styling with a strong architectural form, Coast features concealed security fixings, reinforced braced leg sections and mortise and tenon joints for long-term strength and stability.



The distinctive underframe takes centre stage on Coast. Details such as interlocking triangular leg shapes and table-top with discreet 47-degree edge detail elevate this range.



**TCCO01X**  
Coast 650mm Circular Extreme Coffee Table, X-Spec  
H: 550 WT: 19



**TCCO02X**  
Coast 650 X 650mm Square Extreme Coffee Table, X-Spec  
H: 550 WT: 25.5



**TDCO01X**  
Coast 1100x1100 4 Seater Dining Table; X-Spec  
H: 750 WT: 54.5



**TDCO02X**  
Coast 1440 x 960 4 Seater Rectangular Dining Table, X-Spec  
H: 750 WT: 62.5



**TDCO03X**  
Coast 2000 x 960 6 Seater Rectangular Dining Table, X-Spec  
H: 750 WT: 80



**TDCO04X**  
Coast 2560 x 960 8 Seater Rectangular Dining Table, X-Spec  
H: 750 WT: 99.5



**TDCO05X**  
Coast 3000 x 960 10 Seater Rectangular Dining Table, X-Spec  
H: 750 WT: 114



## Standard Features

- Tough, durable 36mm laminate top with 47-degree edge reference
- Soft radiused corners for added safety
- Easy clean, scratch and heat resistant laminate top
- Interlocking triangular legs secure into the base frame and top frame for added strength
- Solid, 70mm x 70mm beech underframe
- Bolted table-top with concealed security fixings for added safety

## Optional Features

- Wood finish options available (see page 31)



# Arcus Dining & Coffee Tables

Its distinctive cruciform base and robust construction provide exceptional strength and stability, while the four-seat configuration naturally supports more personal space and calmer social interaction.



## Standard Features

- Tough, durable 25mm laminate top with smooth arrised edge (chamfer on top and bottom edge)
- Soft radiused corners for added safety
- Easy clean, scratch and heat resistant top
- Solid, 80mm x 45mm beech underframe sections with cruciform base
- Mortise and tenon construction for added strength
- Bolted table-top with concealed security fixings for added safety

## Optional Features

- Wood finish options available (see page 31)



**TCAR01X**  
Arcus 650mm  
Round Coffee Table, X-Spec  
H: 550 WT: 15.5



**TCAR02X**  
Arcus Extreme 650 x 650mm  
Square Coffee Table, X-Spec  
H: 550 WT: 19



**TDAR01X**  
Arcus 1200 diameter 4 seater  
Round Dining Table, X-Spec  
H: 750 WT: 37



**TDAR02X**  
Arcus 1200 x 1200 4 seater  
Square Dining Table, X-Spec  
H: 750 WT: 46.5



Low to High Risk



# Loop Dining & Coffee Tables

Characterised by its distinctive loop-shaped underframe, Loop has been designed to create a contemporary yet highly durable dining range for challenging environments.



The bolted table-top features concealed security fixings, while braced leg sections and mortise and tenon joints provide strength and stability.



**TDLP01X**  
Loop 900 x 900  
2 Seater Dining Table; X-Spec  
H: 750 WT: 35.5



**TDLP02X**  
Loop 1400 x 900  
4 Seater Dining Table; X-Spec  
H: 750 WT: 47



**TDLP03X**  
Loop 2000 x 900  
6 Seater Dining Table; X-Spec  
H: 750 WT: 67.5



**TDLP04X**  
Loop 2600 x 900  
8 Seater Dining Table; X-Spec  
H: 750 WT: 83

Loop is available in sixteen contemporary wood finishes with contrast finish options.



Low to High Risk

## Standard Features

- Tough, durable 25mm laminate top with smooth arrised edge and support rails under the top
- Soft radiused corners for added safety
- Easy clean, scratch and heat resistant laminate top
- Medicote™ anti-bacterial lacquer for infection control
- Solid, 80mm x 45mm beech underframe sections with bracing bar
- Mortise and tenon construction for added strength
- Bolted table-top with concealed security fixings for added safety

## Optional Features

- Wood finish options available (see page 31)



# Eos Dining & Coffee Tables

At the heart of Eos is a distinctive table collection that creates a sense of presence in any space.



With the unparalleled strength offered by its central steel column, Eos is designed to meet the demands of challenging environments.



**TCEO01X**  
Eos 600 x 600mm  
Extreme Square Coffee Table, X-Spec  
H: 415 WT: 51



**TDEO01X**  
Eos 900 x 900  
Extreme Square Dining Table, X-Spec  
H: 750 WT: 93



**TDEO02X**  
Eos 1100 x 1100  
Extreme Square Dining Table, X-Spec  
H: 750 WT: 104



**TCEO02X**  
Eos 750 x 750mm  
Extreme Square Coffee Table, X-Spec  
H: 415 WT: 51



**TDEO03X**  
Eos 2000 x 1100mm  
Extreme Rectangular Double Pedestal Dining Table, X-Spec  
H: 750 WT: 206



Low to High Risk

## Standard Features

- Tough, durable 36mm top
- Vinyl wrapped KYDEX top or laminate top with arrised edge
- Easy clean, scratch and heat resistant.
- Bolted table-top with security fixings for added safety

## Optional Features

- Base colour options
  - Onyx, Anthracite, Stone, White
- Wood finish options available (see page 31)



## Frame colour options:

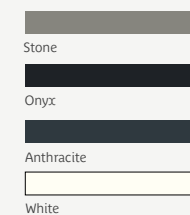

# Portobello Dining Tables



Portobello combines exceptional strength and stability with a softer contemporary aesthetic designed for challenging environments.



## Standard Features

- Vinyl wrapped KYDEX® top or laminate 36mm tops with bullnose edge
- Soft radiused corners for added safety
- Tables feature easy clean, scratch and heat resistant
- Upholstered base
- White Nylon feet allow easy repositioning
- Heavy weighted as standard

## Optional Features

- Customise from a wide range of fabrics to enhance any space (see pages 32-33)
- Wood finish options available (see page 31)

A reinforced weighted structure provides durability and stability, while upholstered detailing and a choice of finishes help create more calmer and welcoming communal spaces.



**TAPO01X**  
Security Soft Square Dining Table

**W:** 1100  
**D:** 1100  
**H:** 800



**TAPO02X**  
Security Round Dining Table

**Dia:** 1100  
**H:** 800



**TAPO03X**  
Security Rectangular Double Pedestal Dining Table

**W:** 2000  
**D:** 1100  
**H:** 800



# Portobello Stools & Coffee Tables



Suitable for a range of settings, Portobello is a multi-use collection of fully upholstered stools and coffee tables.



### Standard Features

- Vinyl wrapped top in either KYDEX® or standard finishes
- Soft radiused corners for added safety
- Tables feature easy clean, scratch and heat resistant tops
- White Nylon feet allow easy repositioning

### Optional Features

- Additional weighting options (see page 28)
- Customise from a wide range of fabrics to enhance any space (see pages 32-33)
- Wood finish options available (see page 31)

## Portobello Coffee Tables

Portobello coffee tables are available in a variety of heights and shapes – round, soft square, hexagonal and rectangular to suit room layout.



**TAP004X**  
Circular Coffee Table

**Base Dia:** 700  
**H:** 460



**TAP005X**  
Square Coffee Table

**W:** 700  
**D:** 700  
**H:** 460



**TAP006X**  
Hexagonal Coffee Table

**W:** 515  
**D:** 580  
**H:** 495



**TAP007X**  
Hexagonal Coffee Table

**W:** 515  
**D:** 580  
**H:** 650



**TAP008X**  
Cylinder Coffee Table

**Dia:** 470  
**H:** 475



**TAP009X**  
Cylinder Coffee Table

**Dia:** 470  
**H:** 650



**TAP010X**  
Soft Square Coffee Table

**W:** 470  
**D:** 470  
**H:** 475



**TAP011X**  
Soft Square Coffee Table

**W:** 470  
**D:** 470  
**H:** 650



**TAP012X**  
Rectangular Coffee Table

**W:** 1030  
**D:** 530  
**H:** 475

### KYDEX® Top Colour Options:



# Tevo



A beautifully presented yet simple table collection with a slim, neat central column. Tevo adds the finishing touch in a multitude of environments. Available in black, brushed steel, brass, or brass and black combinations.



### Standard Features

- Soft, radiused corners for added safety
- Easy clean, scratch and heat resistant 25mm laminate top with tough bullnose edging
- Coffee table, dining table or poseur table options

### Optional Features

- Wood finish options available (see page 31)

### Column & Base Finish

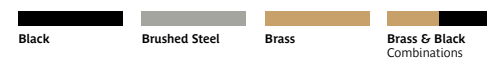

**TCTE-600RD**  
Round Coffee Table  
600 Laminate Top  
  
TCTE-750RD - Dia: 750  
H: 455



**TCTE-600SQ**  
Square Coffee Table  
600 x 600 Laminate Top  
  
TCTE-750SQ - W: 750 D: 750  
H: 455



**TPTE-600RD**  
Round Poseur Table  
600 Laminate Top  
  
TPTE-750RD - Dia: 750  
  
**Square Poseur Table**  
TPTE-600SQ - W: 600 D: 600  
H: 1100



**TDTE-600RD**  
Round Dining Table  
600 Laminate Top  
  
TDTE-750RD - Dia: 750  
TDTE-900RD - Dia: 900  
TDTE-1075RD - Dia: 1075  
TDTE-1200RD - Dia: 1200  
  
H: 745



**TDTE-600SQ**  
Square Dining Table  
600 x 600 Laminate Top  
  
TDTE-750SQ - W: 750 D: 750  
TDTE-900SQ - W: 900 D: 900  
TDTE-1075SQ - W: 1075 D: 1075  
  
H: 745



**TDTE-1200/600 - Rectangular Double Pedestal Dining Table**  
1200 x 600 Laminate Top  
  
TDTE-1200/900 - W: 1200 D: 900  
TDTE-1500/750 - W: 1500 D: 750  
TDTE-1500/900 - W: 1500 D: 900  
TDTE-1800/750 - W: 1800 D: 750  
TDTE-1800/900 - W: 1800 D: 900  
  
H: 745

### Coffee Tables Top Shape Options

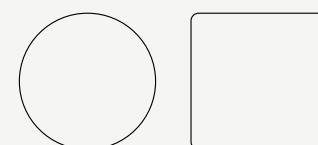

### Dining Tables Top Shape Options



### Poseur Tables Top Shape Options

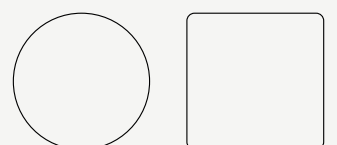

# S-Frame Dining & Coffee Tables



Combining traditional styling with robust structural performance, the S-Frame range supports more homely, residential-style environments within challenging settings.



**TAXF14X** S-Frame Square Security Coffee Table (No underframe option shown)  
H: 750



**TAXF05X** S-Frame Round Security Coffee Table (750rd)  
H: 750



**TAXF06X** S-Frame Rectangular Security Coffee Table (No underframe option shown)  
H: 750

Robust table range featuring soft radiused corners and bullnose edging. S-Frame under structure provides added strength.



Low to Medium Risk

### Standard Features

- 25mm Beech laminate tops with bullnose edging
- Soft, radiused corners for added safety
- Easy clean, scratch and heat resistant laminate top
- Mortise and tenon joints for added strength
- S-Frame with strong, durable solid Beech underframe with 100mm square legs

### Optional Features

- No underframe TAXF14X (sq) TAXF15X (rd)
- Wood finish options available (see page 31)



**TAXF01X** S-Frame Square Security Dining Table (900sq)  
H: 750



**TAXF02X** S-Frame Round Security Dining Table (1200rd)  
H: 750



**TAXF03X** S-Frame Rectangular Security Dining Table (1500 x 900)  
H: 750



# Asterix



Asterix is the ideal accompaniment to any contemporary interior, with a perfect blend of quality and stability. Add personality by pairing the black or brushed steel base with an eye-catching contrast finish.



### Standard Features

- Soft, radiused corners for added safety
- Easy clean, scratch and heat resistant 25mm laminate top with tough bullnose edging
- Square base & column design
- Coffee table, dining table or poseur table options

### Optional Features

- Wood finish options available (see page 31)

### Column & Base Finish



**TCAS-600RD**  
Round Coffee Table  
600 Laminate Top

TCAS-750RD - Dia: 750  
H: 455



**TCAS-600SQ**  
Square Coffee Table  
600 x 600 Laminate Top

TCAS-750SQ - W: 750 D: 750  
H: 455



**TPAS-600RD**  
Round Poseur Table  
600 Laminate Top

TPAS-750RD - Dia: 750  
**Square Poseur Table**  
TPAS-600SQ - W: 600 D: 600  
H: 1100



**TDAS-600RD**  
Round Dining Table  
600 Laminate Top

TDAS-750RD - Dia: 750  
TDAS-900RD - Dia: 900  
TDAS-1075RD - Dia: 1075  
TDAS-1200RD - Dia: 1200

H: 745



**TDAS-600SQ**  
Square Dining Table  
600 x 600 Laminate Top

TDAS-750SQ - W: 750 D: 750  
TDAS-900SQ - W: 900 D: 900  
TDAS-1075SQ - W: 1075 D: 1075

H: 745



**TDAS-1200/600** - Rectangular  
Double Pedestal Dining Table  
1200 x 600 Laminate Top

TDAS-1200/900 - W: 1200 D: 900  
TDAS-1500/750 - W: 1500 D: 750  
TDAS-1500/900 - W: 1500 D: 900  
TDAS-1800/750 - W: 1800 D: 750  
TDAS-1800/900 - W: 1800 D: 900

H: 745

### Coffee Tables Top Shape Options

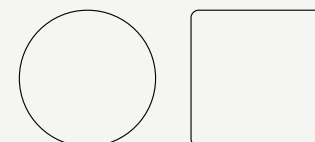

### Dining Tables Top Shape Options

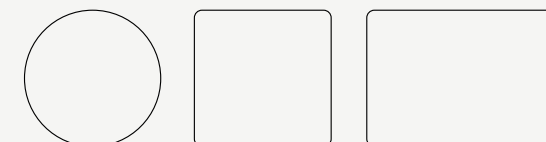

### Poseur Tables Top Shape Options



From high-spec secure seating to softer residential-style dining chairs, this versatile collection offers reinforced construction, supportive comfort and flexible specification options to support safer, more welcoming communal environments.



# Dining Chairs



**Multiple finish options available**  
see pages 30-33 for further information

# Fuerza



Its fully boarded construction and reinforced framework provide extra durability and stability.



**DCFU01X Fuerza**  
High Back Side Chair



**DCFU02X Fuerza**  
High Back Armchair



**DCFU03X Fuerza**  
Low Back Side Chair



**DCFU04X Fuerza**  
Low Back Armchair

*Soft radiused edges, supportive proportions and a wide range of finish options allow Fuerza to create spaces that feel both practical and welcoming.*



Fuerza blends refined contemporary styling with extreme durability, delivering a fixed waterfall seating solution built to perform in the most demanding environments.

Code	Product	H	W	D	AH	SH	SW	SD	WT
DCFU01X	Fuerza High Back Side Chair; X-Spec	1050	510	640	0	480	470	455	40.5
DCFU02X	Fuerza High Back Armchair; X-Spec	1050	620	670	720	480	470	455	53.5
DCFU03X	Fuerza Low Back Side Chair; X-Spec	940	510	640	0	480	470	455	39
DCFU04X	Fuerza Low Back Armchair; X-Spec	940	620	670	720	480	470	455	52



### Standard Features

- Extremely robust, durable chair with fixed seat and back
- X-Spec framework fully boarded for enhanced security
- Solid wood glides for ease of manoeuvrability
- Security fixings throughout

### Optional Features

- Bariatric models available (100mm wider than standard)
- Additional weighting options (see page 28)
- Customise from a wide range of fabrics to enhance any space (see pages 32-33)
- Wood finish options available (see page 31)

# Loop Dining Chair



Beneath the design-led appearance lies a carefully engineered structure built for stability and everyday resilience.



**DCLP01M Loop**  
Dining Side Chair



**DCLP02M Loop**  
Dining Armchair

Loop brings sculptural simplicity, comfort and contemporary design in one confident statement piece. It's flowing arm profile and seamless upholstered form create a softer visual language helping environments feel calmer and more intentionally designed.

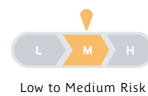

## Standard Features

- Extremely robust, durable chair with fixed seat and back
- M- Specification boarded seat and underside with security screws
- Solid wood glides for ease of manoeuvrability
- Security fixings throughout

## Optional Features

- Customise from a wide range of fabrics to enhance any space (see pages 32-33)
- Wood finish options available (see page 31)
- Additional weighting options available (see page 28)



Code	Product	H	W	D	AH	SH	SW	SD	WT
DCLP01M	Loop Dining Side Chair; M-Spec	860	510	570	-	470	510	455	12.5
DCLP02M	Loop Dining Armchair; M-Spec	860	600	570	705	470	500	455	13.5

# Cove Dining Chair



Every detail has been carefully engineered to support secure environments.



**DCC001X Cove Dining Armchair with Short Seat**



**DCC002X Cove Dining Armchair with Deep Seat**

*The fully upholstered back enhances comfort, while the zero-depth seam seat design reduces concealment opportunities and maintains a clean, uninterrupted silhouette.*



Designed with a fully upholstered form, seamless detailing and a distinctive rounded skid-base frame, Cove moves away from the institutional feel traditionally associated with secure furniture and creates spaces that feel warmer and more human.

Code	Product	H	W	D	AH	SH	SW	SD	WT
DCC001X	Cove Dining Armchair with Short Seat; X-Spec	860	600	570	705	470	500	455	16.5
DCC002X	Cove Dining Armchair with Deep Seat; X-Spec	860	600	570	705	470	500	455	18



### Standard Features

- Extremely robust, durable chair with fixed seat and back
- X-Spec framework fully boarded for enhanced security
- Solid wood glides for ease of manoeuvrability
- Security fixings throughout

### Optional Features

- Customise from a wide range of fabrics to enhance any space (see pages 32-33)
- Wood finish options available (see page 31)
- Additional weighting options available (see page 28)

# Avenue



Characterised by its contemporary show wood frame, Avenue complements any dining or activity space.

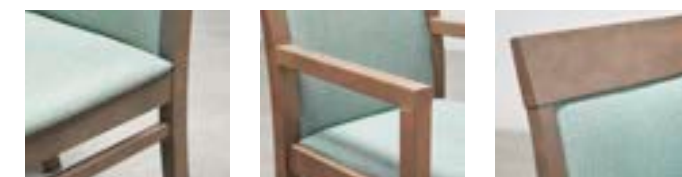

Low to Medium Risk



**DCAV01M Avenue**  
Side Chair



**DCAV02M Avenue**  
Armchair



**DCAV08M Avenue**  
Side Chair  
with Braced Skid Legs



**DCAV09M Avenue**  
Armchair  
with Braced Skid Legs

Code	Product	H	W	D	AH	SH	SW	SD	WT
DCAV01M	Avenue Side Chair; M-Spec	880	480	450	-	500	480	400	8.5
DCAV02M	Avenue Armchair; M-Spec	870	555	525	660	500	480	410	10.5
DCAV08M	Avenue Side Chair with Braced Ski Legs; M-Spec	880	480	540	-	500	480	400	11
DCAV09M	Avenue Armchair with Braced Ski Legs; M-Spec	870	560	560	660	500	480	410	13.5

### Standard Features

- M-Spec boarded seat and underside
- Solid beech frame, mortise and tenon construction for added strength
- Upholstered back
- Security fixings throughout
- Braced integral skid leg frame (**DCAV08M / 09M** models only)

### Optional Features

- Solid beech skid leg option to aid movement (**DCAV01M & DCAV02M**)
- Customise from a wide range of fabrics to enhance any space (see pages 32-33)
- Wood finish options available (see page 31)

# Kasumi



Kasumi brings a touch of class to any dining space. Choose from a selection of fabrics to bring Kasumi to life, or a fluted back to add a stylish accent.



**Standard Features**

- M-Spec framework with boarded seat & underside
- Lumbar support
- Solid beech frame, mortise and tenon construction for added strength

**Optional Features**

- Braced integral skid leg frame
- Fluted back option adds a stylish accent
- Customise from a wide range of fabrics to enhance any space (see pages 32-33)
- Wood finish options available (see page 31)



**DCKA01M**  
Side Chair  
Fully Upholstered  
Seat & Back



**DCKA02M**  
Armchair  
Fully Upholstered  
Seat & Back

Code	Product	H	W	D	AH	SH	SW	SD	WT
DCKA01M	Kasumi Side Chair; Fully Upholstered Back; M-Spec	850	480	520	0	480	480	410	8.5
DCKA02M	Kasumi Armchair; Fully Upholstered Back; M-Spec	850	560	520	670	480	480	410	9.5

# Kurva

Kurva brings a sense of elegance to any dining room, with side chair, armchair and high back dining armchair options to suit every preference.



**DCKU01M** Kurva  
Side Chair



**DCKU02M** Kurva  
Armchair



**DCKU03M** Kurva  
High Back  
Armchair

**Standard Features**

- M-Spec framework with boarded seat & underside
- Solid beech frame, mortise and tenon construction for added strength

**Optional Features**

- Solid beech skid leg option to aid movement
- Customise from a wide range of fabrics to enhance any space (see pages 32-33)
- Wood finish options available (see page 31)



Code	Product	H	W	D	AH	SH	SW	SD	WT
DCKU01M	Kurva Mid Back Side Chair; M-Spec	900	470	550	0	500	470	420	11.5
DCKU02M	Kurva Mid Back Armchair; Stacking; M-Spec	900	560	580	680	500	460	460	12
DCKU03M	Kurva High Back Armchair; Stacking; M-Spec	1000	560	580	680	500	460	460	12

# Anne



Simple yet stylish stacking chair with supportive deep back to ensure optimum posture, suitable for dining and activity spaces.



### Standard Features

- M-Spec framework with boarded seat & underside
- Stacks up to 5 high
- Hygiene / sacral gap
- Upholstered seat & back

### Optional Features

- Customise from a wide range of fabrics to enhance any space (see pages 32-33)
- Wood finish options available (see page 31)



**C501-1M Anne**  
Side Chair



**C503-1M Anne**  
Armchair

Code	Product	H	W	D	AH	SH	SW	SD	WT
C501-1M	Anne Side Chair; Deep Back; Stacking; M-Spec	850	550	959	0	485	420	450	8
C503-1M	Anne Armchair; Deep Back; Stacking; M-Spec	850	550	959	675	485	420	450	8

# Charlotte



Charlotte offers an alternatively styled back to the Anne range. With stylish beech frame and stacking capability, Charlotte is a versatile choice for dining and activity spaces.



### Standard Features

- M-Spec framework with boarded seat & underside
- Stacks up to 5 high
- Hygiene / sacral gap
- Upholstered seat & back

### Optional Features

- Customise from a wide range of fabrics to enhance any space (see pages 32-33)
- Wood finish options available (see page 31)



**C500-1M Charlotte**  
Side Chair



**C502-1M Charlotte**  
Armchair

Code	Product	H	W	D	AH	SH	SW	SD	WT
C500-1M	Charlotte Side Chair; Stacking; M-Spec	850	550	959	0	485	420	450	8
C502-1M	Charlotte Armchair; Stacking; M-Spec	850	550	959	675	485	420	450	8

# Darcey



With its show wood frame Darcey blends style with comfort. Skid leg option available to aid movement, with easy rise arms to assist with sit-to-stand movement.

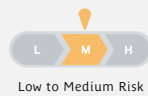

### Standard Features

- M-Spec framework with boarded seat & underside
- Mortise and tenon construction for added strength

### Optional Features

- Customise from a wide range of fabrics to enhance any space (see pages 32-33)
- Wood finish options available (see page 31)



DCDA01M Darcey Side Chair



DCDA02M Darcey Armchair



Code	Product	H	W	D	AH	SH	SW	SD	WT
DCDA01M	Darcey Side Chair; M-Spec	900	460	550	0	510	470	430	8.5
DCDA02M	Darcey Armchair; M-Spec	900	600	590	650	510	470	460	10

# Ikon

Ikon is a well designed multi-purpose chair family with modern aesthetic and stacking capability.



DCIK01M Ikon Side Chair with Upholstered Seat & Plastic Back



DCIK02M Ikon Armchair with Upholstered Seat & Plastic Back



DCIK03M Ikon Side Chair with Upholstered Seat & Back



DCIK04M Ikon Armchair with Upholstered Seat & Back

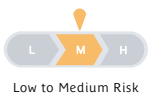

### Standard Features

- M-Spec framework with boarded seat & underside
- High grade, trilliptical steel tube creates a modern aesthetic
- Visually inviting, anatomically moulded seat, back and armrest
- Stacks up to 5 high

### Optional Features

- Customise from a wide range of fabrics to enhance any space (see pages 32-33)

### Metal Frame Finishes



Code	Product	H	W	D	AH	SH	SW	SD	WT
DCIK01M + 03M	Ikon Side Chairs; Stacking; M-Spec	860	535	580	0	475	420	490	6
DCIK02M + 04M	Ikon Armchairs; Stacking; M-Spec	860	600	580	680	475	420	490	6

**Our lightweight stacking chairs support fast-moving spaces that need to transition easily between everyday use, social interaction and multi-functional activity.**



# Stacking Chairs



**Multiple finish options available**  
see pages 30-33 for further information

## Anne & Charlotte

Robust multi-purpose healthcare chairs for visitor, dining and activity areas.



**C501-1M Anne**  
Side Chair

**C503-1M Anne**  
Armchair



### Standard Features

- Stacks up to 5 high
- Hygiene / sacral gap
- Upholstered seat pad and seat back

### Optional Features

- Wood finish options (see page 31)
- Customise from a wide range of fabrics to enhance any space (see pages 32-33)



**C500-1M Charlotte**  
Side Chair



**C502-1M Charlotte**  
Armchair

Code	Product	H	W	D	AH	SH	SW	SD	WT
C501-1M & C500-1M	Side Chairs; Stacking; M-Spec	850	550	959	-	485	420	450	8
C503-1M & C502-1M	Armchairs; Stacking; M-Spec	850	550	959	675	485	420	450	8

## Ikon

Well designed, highly tooled dining or multi-purpose seating range with stacking capability.

### Standard Features

- Stacks up to 5 high
- High grade, triliptical steel tube creates a modern aesthetic
- Visually inviting, anatomically moulded seat, back and armrest



**DCIK03M Ikon**  
Side Chair  
with Upholstered Seat  
& Back



**DCIK04M Ikon**  
Armchair  
with Upholstered Seat  
& Back

### Frame Finishes



Code	Product	H	W	D	AH	SH	SW	SD	WT
DCIK03M	Ikon Side Chair; Stacking; Upholstered Seat, Upholstered Back; M-Spec	860	535	580	-	475	420	490	6
DCIK04M	Ikon Armchair; Stacking; Upholstered Seat, Upholstered Back; M-Spec	860	600	580	680	475	420	490	9

## Luca



**RSLU01 Luca**  
Armchair

Luca multi-environment stacking armchair.

### Standard Features

- Stacks up to 5 high
- Tough, durable plastic utility chair
- Wipe clean for infection control
- UV colour resistance

### Finishes



Grey

Code	Product	H	W	D	AH	SH	SW	SD	WT
RSLU01	Luca Armchair; Stacking	830	570	510	675	460	390	400	4.5

## Breeze



**DCBR01 Breeze**  
Children's Stacking Chair  
6 size options available

Breeze children's stacking chairs are designed to promote good posture and provide exceptional comfort.

### Finishes



Other finish options available on request

### Standard Features

- Stacks up to 12 high
- Durable, stain resistant and 100% recyclable
- Safe, stable design

### Optional Features

- Seat Height options:  
260, 310, 350, 380, 430, 460mm

Code	Product	H	W	D	AH	SH	SW	SD	WT
DCBR01	Breeze Stacking Chair; 260sh	500	360	330	-	260	280	250	1.5

## Tonina

Tonina is a stylish, flexible and compact stacking chair inspired by shapes in nature, designed exclusively by Claudio Dondoli.



**RSTN01 Tonina**  
Side Chair



**RSTN02 Tonina**  
Armchair



**RSTN03 Tonina**  
Side Chair with Seat Pad,  
Seat Pad available in a wide  
range of fabrics

**RSTN04 Tonina**  
Armchair with Seat Pad

### Standard Features

- UV colour resistance
- Stacks up to 6 high

### Finishes



Touch of grey

Code	Product	H	W	D	AH	SH	SW	SD	WT
RSTN01 & 03	Tonina Side Chairs	810	505	520	-	465	390	420	4
RSTN02 & 04	Tonina Armchairs	810	505	520	670	465	390	420	5

Designed to support a wide range of environments and levels of risk, this versatile seating collection combines flexible specifications, weighting options and contemporary seating styles for everyday therapeutic living.



# Sofas+ Armchairs



**Multiple finish options available**  
see pages 30-33 for further information

# Olivia

Combining a contemporary retro-inspired silhouette with exceptional versatility, Olivia offers flexible upholstery and specification options suited to a wide range of environments.



Olivia SSOV22 2 seater sofa and Olivia SSOV21 armchair with looped leg & removable seat.



**Standard Features**

- Distinctive, contemporary aesthetic with stylish looped metal underframe
- M or X-Spec framework available (See page 29)
- Upholstery options of removable seat, fixed seat or Plus+ one piece upholstery\*

**Optional Features**

- Customise from a wide range of fabrics to enhance any space (see pages 32-33)
- Additional weighting options (see page 28)
- Frame colour options: Onyx, Anthracite, Stone

Code	Product	H	W	D	AH	SH	SW	SD	WT
SSOV21M / 23M+	Oliva Armchair; Looped Leg Underframe; Complete Upholstery; M-Spec	785	870	750	700	460	530	570	34
SSOV22M / 22M+	Oliva 2 Seater Sofa; Looped Leg Underframe; Complete Upholstery; M-Spec	785	1460	750	700	460	1100	570	56.5
SSOV23M / 23M+	Oliva 3 Seater Sofa; Looped Leg Underframe; Complete Upholstery; M-Spec	785	2050	750	700	460	1690	570	65

Soft contoured edges and deep-filled cushioning help create comfortable, more welcoming lounge spaces.



**SSOV21M+ Olivia**  
Armchair  
with Plus+ One Piece Upholstery



**SSOV22M+ Olivia**  
2 Seater Sofa  
with Plus+ One Piece Upholstery



**SSOV23M+ Olivia**  
3 Seater Sofa  
with Plus+ One Piece Upholstery

**SSOV21M Olivia**  
Armchair  
with Removable  
or Fixed Seat

**SSOV22M Olivia**  
2 Seater Sofa  
with Removable  
or Fixed Seat

**SSOV23M Olivia**  
3 Seater Sofa  
with Removable  
or Fixed Seat

With consideration for comfort and modern aesthetic, Olivia combines elements of design with functionality with contrast metal underframe available in a range of colours, stylish shaped arms and both fixed and removable seat options.



*Bringing contemporary elegance to any room, Olivia is the perfect enhancement for any space.*

Frame colour options:

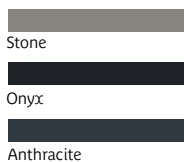

# Cantabria



It's durable build and carefully considered upholstery design help reduce concealment and support long-term performance, while fixed and removable seating options provide additional flexibility.



SSCA21M Cantabria  
Armchair



SSCA22M Cantabria  
2 Seater Sofa



SSCA23M Cantabria  
3 Seater Sofa

Wide proportions, deep seating and oversized profile arms give Cantabria a relaxed, supportive feel designed for comfortable everyday use.



Low to High Risk

### Standard Features

- Contemporary styling & generous seating area
- M or X-Spec framework available (See page 29)
- Removable seat & back or zero depth seam: fully sealed to prevent concealment and aid cleaning (fixed seat only)
- Block Foot
- Security fixings used throughout

### Optional Features

- Customise from a wide range of fabrics to enhance any space (see pages 32-33)
- Additional weighting options (see page 28)
- Wood stain options with Medicote™ anti-bacterial lacquer (see page 31)

\*only available on selected fabrics & vinyl's with strengthened seams

Code	Product	H	W	D	AH	SH	SW	SD
SSCA21M	Cantabria Armchair; M-Spec	690	1030	1000	615	400	650	635
SSCA22M+	Cantabria 2 Seater Sofa; M-Spec	690	1680	1000	615	400	1300	635
SSCA23M+	Cantabria 3 Seater Sofa; M-Spec	690	2005	1000	615	400	1625	635

Available in armchair, two-seater and three-seater options.



# Marli

A uniquely styled and contemporary soft seating collection. An inviting sit with excellent ergonomics for client levels up to all levels of security environments.



SSMR01X Marli  
Armchair



SSMR02X Marli  
2 Seater Sofa



SSMR03X Marli  
3 Seater Sofa



## Standard Features

- Contemporary design with elegant curved sides
- Soft, contoured edges with deep filled back, arm and seat
- X-Spec framework fully boarded for enhanced security
- Zero depth seam upholstery to prevent concealment\*
- Robust, styled legs secured into the frame for added strength
- Security fixings used throughout

\*only available on selected fabrics & vinyl's with strengthened seams

## Optional Features

- Quilted back upholstery option
- Customise from a wide range of fabrics to enhance any space (see pages 32-33)
- Additional weighting options (see page 28)
- Wood stain options with Medicote™ anti-bacterial lacquer (see page 31)

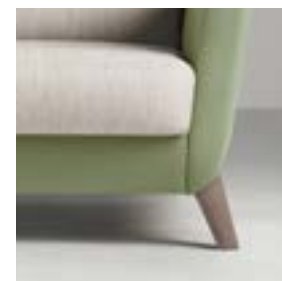

Code	Product	H	W	D	AH	SH	SW	SD	WT
SSMR01X	Marli Armchair	890	850	840	675	490	570	570	31.5
SSMR02X	Marli 2 Seater Sofa	890	1370	840	675	490	1110	570	56.5
SSMR03X	Marli 3 Seater Sofa	890	1960	840	675	490	1670	570	81.5

# Murano



Murano combines smooth organic forms with ultra-contemporary styling to create a softer, calmer visual presence within lounge and de-escalation spaces.



**SSMU02X+**  
2 Seater Sofa

*The curved profile allows easier interaction and positioning for both staff and service users, while its welcoming non-imposing design helps encourage comfort and conversation.*

*Ideal for all areas including lounge, quiet spaces, de-escalation and reception areas.*



### Standard Features

- Excellent comfort with smooth organic shape, waterfall seat and ultra-contemporary design
- Reduced ligature flowing design with rounded corners - difficult to pick up and grasp
- Suited for de-escalation environments with inward sloping arms
- X-Spec framework fully boarded for enhanced security
- Plus+ one piece cover, fully sealed to prevent concealment and aid cleaning\*
- Glide foot
- Security fixings used throughout

### Optional Features

- Customise from a wide range of fabrics to enhance any space (see pages 32-33)
- Additional weighting options available (see page 28)

\*only available on selected fabrics & vinyl's with strengthened seams

Code	Product	H	W	D	AH	SH	SW	SD	WT
SSMU02X+	Murano 2 Seater Sofa; Complete Upholstery; X-Spec	850	1900	800	N/A	430	1050	525	68.5



# Jem

A contemporary statement piece with distinctive silhouette, Jem's generous outer proportions ensure a sense of personal space while the inner profile creates a snug and comfortable seating position.



**SSJM01X**  
Armchair



**SSJM02X**  
2 Seater Sofa



**SSJM03X**  
3 Seater Sofa



**SSJM04X**  
Footstool



## Standard Features

- Generous proportions
- Designed to give individuals a sense of personal space
- X-Spec framework fully boarded for enhanced security
- Plus+ one piece cover, fully sealed to prevent concealment and aid cleaning\*
- Glide foot
- Security fixings used throughout

## Optional Features

- Customise from a wide range of fabrics to enhance any space (see pages 32-33)
- Additional weighting options (see page 28)
- Wood glide stain options with Medicote™ anti-bacterial lacquer (see page 31)

\*only available on selected fabrics & vinyl's with strengthened seams



Code	Product	H	W	D	AH	SH	SW	SD	WT
SSJM01X	Jem Armchair; X-Spec	840	930	800	650	440	480	550	33
SSJM02X	Jem 2 Seater Sofa; X-Spec	840	1510	800	650	440	1070	550	54.5
SSJM03X	Jem 3 Seater Sofa; X-Spec	840	1900	800	650	440	1450	550	74
SSJM04X	Jem Footstool; X-Spec	370	600	600	N/A	370	600	600	10.5

# Meridian



Beneath its refined appearance lies a purpose-built construction engineered for challenging environments. Weighted for stability and fitted with fixed waterfall seating, Meridian integrates discreet security detailing throughout.



TSME01X+ Meridian  
Tub Chair



TSME02X+ Meridian  
2 Seater Sofa

Elegant in appearance yet uncompromising in function, Meridian offers a reassuring balance of comfort, control and contemporary design for today's secure interiors.

A versatile tub chair and 2-seater sofa range for bedroom, lounge or reception.



Low to High Risk

## Standard Features

- Contemporary design
- X-Spec framework fully boarded for enhanced security
- Fixed seat or Plus+ one piece upholstery\*
- Waterfall seat design
- Low, solid, security block feet
- Security fixings throughout

## Options

- Customise from a wide range of fabrics to enhance any space (see pages 32-33)
- Additional weighting options (see page 28)
- Wood glide stain options with Medicote™ anti-bacterial lacquer (see page 31)

\*only available on selected fabrics & vinyl's with strengthened seams

Code	Product	H	W	D	AH	SH	SW	SD	WT
TSME01X+	Meridian Tub Chair; Complete Upholstery; X-Spec	790	720	730	690	440	500	520	26
TSME02X+	Meridian 2 Seater Sofa; Complete Upholstery; X-Spec	790	1220	730	690	440	1000	520	39



# Orla



A contemporary take on a vintage style, Orla is based on the classic Chesterfield model with low back and curved sides. These quintessential features exude elegance and comfort. Retro-inspired legs with a modern twist.



Low to High Risk



**SSOR01M Orla**  
Armchair



**SSOR02M Orla**  
2 Seater Sofa



**SSOR03M Orla**  
3 Seater Sofa

### Standard Features

- Supportive-sit sprung fixed seat for extra comfort
- Stylish design with tapered leg shape
- M-Spec framework with boarded seat & underside
- Plus+ one piece cover, fully sealed to prevent concealment and aid cleaning\*
- Leg height for hoist access

\*only available on selected fabrics & vinyl's with strengthened seams

### Optional Features

- Customise from a wide range of fabrics to enhance any space (see pages 32-33)
- Wood finish options available (see page 31)

Code	Product	H	W	D	AH	SH	SW	SD	WT
SSOR01M	Orla Armchair; Fixed Seat; M-Spec	810	950	760	-	510	500	540	29
SSOR02M	Orla 2 Seater Sofa; Fixed Seat; M-Spec	810	1500	760	-	510	1050	540	41
SSOR03M	Orla 3 Seater Sofa; Fixed Seat; M-Spec	810	2000	760	-	510	1550	540	51

# Asuka



With a relaxing, calming, and welcoming feel due to a soft and rounded organic appearance, Asuka has a low back, generous seating area and fully sealed single piece upholstered seat.



Low to High Risk



**SSRA01X**  
Armchair



**SSRA02X**  
2.5 Seater sofa

**SSRA03X**  
3.5 Seater sofa

### Standard Features

- Flowing design with rounded corners with waterfall seat
- X-Spec framework fully boarded for enhanced security
- Plus+ one piece cover, fully sealed to prevent concealment and aid cleaning\*
- Low profile skid legs

### Optional Features

- Customise from a wide range of fabrics to enhance any space (see pages 32-33)
- Additional weighting options (see page 28)
- Wood finish options available (see page 31)

\*only available on selected fabrics & vinyl's with strengthened seams

Code	Product	H	W	D	AH	SH	SW	SD	WT
SSRA01X	Asuka Armchair; Complete Upholstery; X-Spec	700	1240	1000	-	410	510	610	55
SSRA02X	Asuka 2.5 Seater Sofa; Complete Upholstery; X-Spec	700	1980	1000	-	410	1220	610	78
SSRA03X	Asuka 3.5 Seater Sofa; Complete Upholstery; X-Spec	700	2670	1000	-	410	1920	610	120

# Jenna



## Standard Features

- Excellent comfort and ergonomic support with weighted base option for additional stability and security
- Ligature reducing design, difficult to pick up
- X-Spec framework fully boarded for enhanced security
- Plus+ one piece cover, fully sealed to prevent concealment and aid cleaning\*
- Glide foot (plastic glides)
- Security fixings throughout

\*only available on selected fabrics & vinyl's with strengthened seams

## Optional Features

- Customise from a wide range of fabrics to enhance any space (see pages 32-33)
- Additional weighting options (see page 28)

Code	Product	H	W	D	SH	SW	SD	WT
SSJE01X	Jenna Mid Back Armchair; Complete Upholstery; X-Spec	950	820	820	460	480	550	36
SSJE02X	Jenna High Back Armchair; Complete Upholstery; X-Spec	1280	820	820	460	480	550	37.5
SSJE03X	Jenna Wingback Armchair; Complete Upholstery; X-Spec	1300	820	820	460	480	550	37.5
SSJE04X	Jenna Mid Back 2 Seater Sofa; Complete Upholstery; X-Spec	950	1420	820	460	480	1080	55

Jenna offers a fresh interpretation and styling, with high and mid supportive back to create a visually striking collection.



**SSJE01X**  
Mid Back  
Armchair



**SSJE02X**  
High Back  
Armchair



**SSJE03X**  
Wingback  
Armchair



**SSJE04X**  
Mid Back  
2 Seater Sofa



*Ideal for all areas including lounge, quiet spaces, de-escalation and reception areas.*

# Corsica



Contemporary lines, spacious seat, wide voluminous arms and cuboid profile lend a relaxed and comfortable air to any room.



Low to High Risk

## Standard Features

- Contemporary styling & generous seating area
- M or X-Spec framework available (See page 29)
- Plus+ Complete upholstery: fully sealed to prevent concealment and aid cleaning
- Fixed waterfall seat
- Glide foot
- Security fixings used throughout

## Optional Features

- Customise from a wide range of fabrics to enhance any space (see pages 32-33)
- Additional weighting options (see page 28)
- Wood glide stain options with Medicote™ anti-bacterial lacquer (see page 31)

Code	Product	H	W	D	AH	SH	SW	SD	WT
SSCR01M+	Corsica Armchair; Complete Upholstery; M-Spec	940	940	895	665	455	600	575	36.5
SSCR02M+	Corsica 2 Seater Sofa; Complete Upholstery; M-Spec	940	1540	895	665	455	1200	575	56
SSCR03M+	Corsica 3 Seater Sofa; Complete Upholstery; M-Spec	940	2140	895	665	455	1800	575	76

The sewn in seams prevent concealment and are easily cleaned. Ideal for larger day spaces, lounges, circulation breakout areas and areas of greater risk.



SSCR01M+ Corsica  
Armchair

SSCR01X+ Corsica  
Armchair



SSCR02M+ Corsica  
2 Seater Sofa

SSCR02X+ Corsica  
2 Seater Sofa



SSCR03M+ Corsica  
3 Seater Sofa

SSCR03X+ Corsica  
3 Seater Sofa

Available in armchair, two-seater and three-seater options, Corsica can be specified in Standard, strengthened M-Spec and Extreme X-Spec configurations to suit medium and high secure environments.



# Suki



Suki, with a focus on comfort and modern styling is perfectly at home in a variety of settings. With a supportive back and a stylish fixed waterfall seat cushion Suki ensures no compromise on aesthetics.



**TSSU01M+ Suki**  
Tub Chair



**TSSU03M+ Suki**  
2 Seater Sofa

#### Standard Features

- M & X-Spec framework available (see page 29)
- Plus+ one piece cover, fully sealed to prevent concealment and aid cleaning\*
- Stylish block feet
- Security fixings used throughout

#### Optional Features

- Security fixings used Throughout
- Skid Legs
- Additional weighting options available (see page 28)
- Wood glide stain options with Medicote™ anti-bacterial lacquer (see page 31)

\*Only available on selected fabrics & vinyl's with strengthened seams



Code	Product	H	W	D	AH	SH	SW	SD	WT
TSSU01M+	Suki Armchair; Fixed Seat; M-Spec	875	740	720	645	455	510	520	33.5
TSSU03M+	Suki 2 Seater Sofa; Fixed Seat; M-Spec	875	1260	720	645	455	1000	520	48.5

# Astra Quantum



Extremely robust security chairs and sofas with mid and high back options, designed for high risk security environments, with fully sealed upholstery.



**SSAQ21+ Astra Quantum**  
High Back Armchair



**SSAQ22+ Astra Quantum**  
High Back 2 Seater Sofa



**SSAQ23+ Astra Quantum**  
High Back 3 Seater



**SSAQ24+ Astra Quantum**  
Mid Back Armchair



**SSAQ25+ Astra Quantum**  
Mid Back 2 Seater Sofa



**SSAQ26+ Astra Quantum**  
Mid Back 3 Seater



Code	Product	H	W	D	AH	SH	SW	SD	WT
SSAQ21+	Astra Quantumn High Back Armchair; X-Spec	1040	720	900	680	500	520	560	46
SSAQ22+	Astra Quantumn High Back 2 Seater Sofa; X-Spec	1040	1240	900	680	500	1040	560	67
SSAQ23+	Astra Quantumn High Back 3 Seater Sofa; X-Spec	1040	1800	900	680	500	1580	560	92
SSAQ24+	Astra Quantumn Mid Back Armchair; X-Spec	890	720	900	680	500	520	560	44
SSAQ25+	Astra Quantumn Mid Back 2 Seater Sofa; X-Spec	890	1240	900	680	500	1040	560	65
SSAQ26+	Astra Quantumn Mid Back 3 Seater Sofa; X-Spec	890	1800	900	680	500	1580	560	89

### Standard Features

- Anti-tip design
- Deep filled back, arms and seat cushion for superior comfort
- Contoured back with lumbar support and supportive arms
- X-Spec framework, fully boarded for enhanced security
- Plus+ one piece cover, fully sealed to prevent concealment and aid cleaning\*
- Solid wood glides for ease of manoeuvrability
- Security fixings used throughout

\*Only available on selected fabrics & vinyl's with strengthened seams

### Optional Features

- Security fixings used throughout
- Additional weighting options available (see page 28)
- Wood glide stain options with Medicote™ anti-bacterial lacquer (see page 31)

# Linx



A modular, highly configurable range with soft appearance and feel, characterised by sumptuous levels of comfort. Ideal for all areas including staff areas, lounge, quiet spaces, and reception areas.



**LNX1 Linx**  
Seat Unit  
600w



**LNX2 Linx**  
Seat Unit  
900w



**LNX3 Linx**  
Seat Unit  
1200w



**LNX4 Linx**  
2.5 Seat Unit  
1500w



**LNX5 Linx**  
3 Seat Unit  
1800w



**LNX6 Linx**  
Corner Seat Unit



**LNX7 Linx**  
Base Unit  
600w



**LNX8 Linx**  
Base Unit  
900w

**LNX9 Linx**  
Coffee Table  
900sq



## Standard Features

- Modular design offers an infinite number of configurations
- Creates a truly flexible space, ideal for socialising and interaction
- X-Spec framework fully boarded for enhanced security
- Solid Beech inset glides
- Security fixings used throughout

## Unit Options

- Mid back seating units (600, 900, 1200, 1500, 1800 width options)
- Corner seat unit
- Base unit (600 & 900 width options)
- Co-ordinating coffee table (900sq)
- Arm options

## Optional Features

- Units can be linked together
- Air piping option creates a defined seam that leads the eye with ease around the sofa profile
- Customise from a wide range of fabrics to enhance any space (see pages 32-33)
- Additional weighting options (see page 28)
- Wood glide stain options with Medicote™ anti-bacterial lacquer (see page 31)

Code	Product	H	W	D	AH	SH	SW	SD	WT
LN1	Linx Single Chair; X-Spec	880	640	930	N/A	445	640	550	31
LN2	Linx Single 940w Sofa; X-Spec	880	940	930	N/A	445	940	550	24
LN3	Linx Single 1240w Sofa; X-Spec	880	1240	930	N/A	445	1240	550	52
LN4	Linx Single 1540w Sofa; X-Spec	880	1540	930	N/A	445	1540	550	63
LN5	Linx Single 1840w Sofa; X-Spec	880	1840	930	N/A	445	1840	550	73
LN6	Linx Corner Unit; X-Spec	880	1010	930	N/A	445	N/A	550	53
LN7	Linx Single 600w Footstool; X-Spec	445	640	640	N/A	445	640	640	17
LN8	Linx Single 900w Footstool; X-Spec	445	930	930	N/A	445	940	930	32
LN9	Linx Single 900w Table; X-Spec	445	930	930	N/A	445	940	930	35

*Linx creates a truly flexible space, ideal for socialising and interaction in a variety of settings.*

## Piping



Standard



Air piping option



Seat Unit with arms

# Soltaire



Soltaire lends itself to a variety of settings, offering the dual benefit of comfort and durability.

A modular solution that can be configured to create a variety of layouts in staff, reception and atrium spaces.



**TSSO01X Soltaire**  
Single Chair



**TSSO02X Soltaire**  
2 Seater Sofa



**TSSO03X Soltaire**  
3 Seater Sofa



**TSSO04X Soltaire**  
Coffee Table



**TSSO05X Soltaire**  
Single chair / Corner / Single Chair  
(Shown with arm option)



**TSSO06X Soltaire**  
2 Seater Sofa / Corner / Single Chair  
(Shown with arm option)



**TSSO07X Soltaire**  
Single chair / Corner / 2 Seater Sofa  
(Shown with arm option)



**TSSO08X Soltaire**  
2 Seater sofa / Corner / 2 Seater Sofa  
(Shown with arm option)



**TSSO09X Soltaire**  
Corner Unit



Low to High Risk

## Standard Features

- Extremely robust, durable seating range with fixed seat and back
- Matching coffee table
- X-Spec framework fully boarded for enhanced security
- Glide foot

## Optional Features

- Arm options
- Customise from a wide range of fabrics to enhance any space (see pages 32-33)
- Additional weighting options available (see page 28)
- Wood glide stain options with Medicote™ anti-bacterial lacquer (see page 31)

Code	Product	H	W	D	AH	SH	SW	SD	WT
TSSO01X	Soltaire Single Unit Chair; X-Spec	900	580	850	N/A	450	580	570	28
TSSO02X	Soltaire 2 Seater Unit Sofa; X-Spec	900	1180	850	N/A	450	1180	570	44
TSSO03X	Soltaire 3 Seater Unit Sofa; X-Spec	900	1730	850	N/A	450	1730	570	68
TSSO04X	Soltaire Table; Fixed Seat; X-Spec	460	730	730	N/A	500	520	560	26.5
TSSO05X	Soltaire Single Unit, Corner Unit, Single Unit Configuration; X-Spec	900	1480	1480	N/A	450	1280	570	90.5
TSSO06X	Soltaire 2 Seater Unit, Corner Unit, Single Unit Configuration; X-Spec	900	2080	1480	N/A	450	1880	570	106.5
TSSO07X	Soltaire Single Unit, Corner Unit, 2 Seater Unit Configuration; X-Spec	900	1480	2080	N/A	450	1880	570	106.5
TSSO08X	Soltaire 2 Seater Unit, Corner Unit, 2 Seater Unit Configuration; X-Spec	900	2080	2080	N/A	450	1880	570	122.5
TSSO09X	Soltaire Corner Unit Only; X-Spec	900	900	900	N/A	450	700	570	34.5

*Soltaire creates a truly flexible space, ideal for socialising and interaction in a variety of settings.*



# Maldive Modular



Create an informal and contemporary space for socialising and relaxation with Maldive. Comprising of individual pieces, Maldive is a modular system available with a choice of cushions, leg styles and arm options.

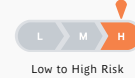

### Upholstery Options

- Removable seat & back
- Fixed seat & removable back
- Fixed seat & zip fixed back
- Fixed seat & fixed back (excluding corner units)

### Standard Features

- Modular design offering a wide range of configurations
- M or X-Spec framework available (see page 29)
- Round or tapered arm styles
- Block or solid beech glide legs
- Security fixings used throughout

### Optional Features

- Customise from a wide range of fabrics to enhance any space (see pages 32-33)
- Additional weighting options (see page 28)
- Wood glide stain options with Medicote™ anti-bacterial lacquer (see page 31)

Code	Product	H	W	D	AH	SH	SW	SD	WT
SSML01M	Armchair; Tapered Arm; M-Spec	940	940	895	665	455	600	575	36.5
SSML02M	2 Seater Sofa; Tapered Arm; M-Spec	940	1540	895	665	455	1200	575	56
SSML31M	Large Footstool Unit; M-Spec	480	860	860	0	480	860	860	25



**SSML-1AM Maldive**  
Single Unit Chair  
Right hand arm



**SSML-1M Maldive**  
Single Unit Chair



**SSML-A1M Maldive**  
Single Unit Chair  
Left hand arm



**SSML-CM Maldive**  
Corner unit



**SSML01M Maldive**  
Armchair  
with Tapered Arms



**SSML02M Maldive**  
2 Seater Sofa  
with Tapered Arms



**SSML31 Maldive**  
Large Footstool

Maldive configurations require a site survey to confirm configuration & access.

### Leg Options



Block foot



Glide foot

### Arm Options



Round arm



Tapered arm



**SSML26 Maldive** 3 Seater, Corner Unit, 2 Seater; Round Arms

# Atlas



A robust, durable and comfortable easy chair with contoured supportive high back. Developed for multi-environment use up to high risk security environments.

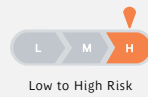

### Standard Features

- Contoured, supportive back
- Robust durable easy chair
- M & X-Spec framework available (see page 29)
- Leg height for hoist access
- Security fixings throughout

### Optional Features

- Security fixings throughout
- Reflexion® pressure relief seat
- Additional weighting options (see page 28)
- Wood finish options available (see page 31)

Code	Product	H	W	D	AH	SH	SW	SD	WT
LSAT01M	Atlas High Back Armchair; Fixed Seat; M-Spec	1160	690	800	700	510	510	540	-
LSAT02M	Atlas Wingback Armchair; Fixed Seat; M-Spec	1160	690	800	700	510	510	540	40
LSAT03M	Atlas Mid Back Armchair; Fixed Seat; M-Spec	955	690	800	700	510	510	540	33.5
LSAT11	Atlas High Back Bariatric Armchair (35st); Fixed Seat	1160	810	885	700	510	650	550	-

The Atlas series is flexible in its offering; available with high or mid back, fixed seat cushions and wings.



LSAT01M Atlas  
High Back Armchair



LSAT02M Atlas  
High Back Armchair  
with Wing



LSAT03M Atlas  
Mid Back Armchair



LSAT11 Atlas  
Bariatric Armchair  
Maximum User Weight  
220kg (35st)

Optional Reflexion® pressure relief seating, hoist-accessible design and a choice of contemporary fabric and wood finishes.

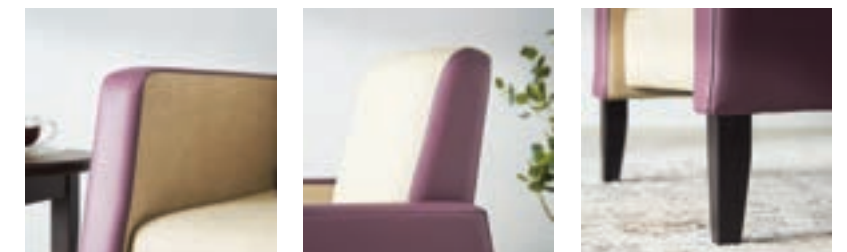

# Sicily



With its clean contemporary styling and supportive cushioned comfort, Sicily brings a softer residential feel while delivering the robust performance required for everyday use.



**SSSI21M Sicily**  
Armchair



**SSSI22M Sicily**  
2 Seater Sofa



**SSSI23M Sicily**  
3 Seater Sofa

**Standard Features**

- Contemporary styling
- M-Spec framework with boarded seat & underside
- Removable seat & back cushion
- Security fixings used throughout

**Optional Features**

- Customise from a wide range of fabrics to enhance any space (see pages 32-33)
- Additional weighting options available (see page 28)
- Wood glide stain options with Medicote™ anti-bacterial lacquer (see page 31)

Code	Product	H	W	D	AH	SH	SW	SD	WT
SSSI21M	Sicily Armchair; Removable Seat; M-Spec	950	700	810	710	520	510	490	41.5
SSSI22M	Sicily 2 Seater Sofa; Removable Seat; M-Spec	950	1250	810	710	520	1060	490	57
SSSI23M	Sicily 3 Seater Sofa; Removable Seat; M-Spec	950	1785	810	710	520	1600	490	71.5

# Virtuoso

Virtuoso is a statement range of chairs that gets noticed and provides a beautiful accent to any room.

Available as a low back, high back or high back with curved wings, and with a fixed or loose seat cushion\*, Virtuoso is as comfortable as it is good looking.

**Standard Features**

- Contemporary styling
- M-Spec framework with boarded seat & underside
- Security fixings used throughout

**Optional Features**

- Customise from a wide range of fabrics to enhance any space (see pages 32-33)
- Wood finish options (see page 31)



**LSVR01M Virtuoso**  
Low Back Armchair



**LSVR02M Virtuoso**  
High Back Armchair



**LSVR03 Virtuoso**  
Ottoman stool



**LSVR04M Virtuoso**  
2 Seater Sofa  
\*fixed seat only



**LSVR05M Virtuoso**  
Mid Back Armchair



**LSVR06 Virtuoso**  
Footstool

Code	Product	H	W	D	AH	SH	SW	SD	WT
LSVR01M	Virtuoso Low Back Armchair; M-Spec	880	670	770	600	460	440	560	20
LSVR02M	Virtuoso Wingback Armchair; No Buttons; M-Spec	1240	670	790	600	430	440	550	24.5
LSVR03	Virtuoso Ottoman Stool	435	610	580	-	-	-	-	-
LSVR04M	Virtuoso Mid Back 2 Seater Sofa; Fixed Seat; M-Spec	900	1180	720	600	430	980	550	37
LSVR05M	Virtuoso Mid Back Armchair; M-Spec	1030	670	790	600	430	440	550	21.5
LSVR06	Virtuoso Footstool	410	510	250	-	-	-	-	-

# Fawley

Fawley is a timeless addition to any space. With its gently curved silhouette this stylish tub chair is perfectly at home in a bedroom, lounge or reception space.

### Standard Features

- Softly rounded back for support and comfort
- Compact footprint
- M-Spec framework with boarded seat and underside
- Removable seat
- Integrated show wood legs
- Security fixings throughout

### Optional Features

- Customise from a wide range of fabrics to enhance any space (see pages 32-33)
- Reflexion® pressure relief seat
- Additional weighting options available (see page 28)
- Wood finish options available (see page 31)



Fawley TSFA01 shown with F11 Coffee Table with Shorewood top.



**TSFA01M Fawley**  
Tub Chair



**TSFA02M Fawley**  
2 Seater Sofa



Code	Product	H	W	D	AH	SH	SW	SD	WT
TSFA01M	Fawley Tub Chair; Removable Seat; M-Spec	790	770	700	700	570	420	480	19
TSFA02M	Fawley 2 Seater Sofa; Removable Seat; M-Spec	790	1300	700	700	570	950	480	-

# Portobello Stools



Suitable for a range of settings, Portobello is a multi-use collection of fully upholstered stools and coffee tables.



**SSPO01X**  
Hexagonal Stool

**W:** 515  
**D:** 580  
**H:** 495



**SSPO02X**  
Cylinder Stool

**Dia:** 470  
**H:** 510



**SSPO03X**  
Soft Square Stool

**W:** 470  
**D:** 470  
**H:** 510



**SSPO04X**  
Rectangular Bench Stool

**W:** 1030  
**D:** 530  
**H:** 510



### Standard Features

- X-Spec framework fully boarded for enhanced security
- Nylon feet (with security screws) allows easy repositioning
- Security fixings throughout

### Optional Features

- Customise from a wide range of fabrics to enhance any space (see pages 32-33)
- Additional weighting options available (see page 28)
- Wood finish options available (see page 31)

# Buddy Day Bed



Buddy Day Bed BDBU21 / Day Bed / Attendant Chair

**Buddy is designed for relaxation and for family sleepovers in patient rooms. Ideal for maternity, paediatrics and palliative care.**



Low to Medium Risk

## Standard Features

- Stylish contemporary space saving design
- Easy operation
- Extends to 2m bed
- Fully open head area for clear visibility
- Storage boxes under seat for pillows & blankets, with protective cover
- In-line locking front castors. Swivel rear castors for manoeuvrability. Easy push button operation
- Reclines to any angle
- Maximum user weight: 160kg (25st)

## Options

- Two width options: standard model and Buddy compact - where room size only permits a small footprint.
- Customise from a wide range of fabrics to enhance any space (see pages 32-33)



**BDBU21 Buddy**  
Day Bed /  
Attendant Chair

OW: 870  
SW: 640



**BDBU22 Buddy**  
Compact Day Bed /  
Attendant Chair

OW: 730  
SW: 500



*Buddy features easy push button operation, allowing the back to be lowered or raised. The continuous movement back can be stopped in any position for personalised comfort.*



**Stylish contemporary design and easy to operate, Buddy extends to a 2-metre bed, with fully open head area and storage compartment with protective cover for pillows, blankets and other accessories.**



# Christie

Flexible and eminently usable in a myriad of spaces, the Christie has a generous seat and curved supportive back making it a very popular range.

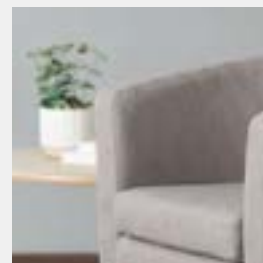

**TSCH21M Christie**  
Low Back Armchair



**TSCH22M Christie**  
Mid Back Armchair



**TSCH23M Christie**  
High Back Armchair



**TSCH24M Christie**  
Mid Back 2 Seater Sofa



**TSCH25M Christie**  
Tub Chair



Low Risk

## Standard Features

- Distinctive, contemporary styling
- Curved supportive back
- M-Spec framework with boarded seat & underside
- Security fixings throughout

## Options

- Customise from a wide range of fabrics to enhance any space (see pages 32-33)
- Reflexion® pressure relief seat
- Additional weighting options (see page 28)
- Wood finish options (see page 31)



Code	Product	H	W	D	AH	SH	SW	SD	WT
TSCH21M	Christie Low Back Armchair; M-Spec	790	780	690	700	470	550	510	18.5
TSCH22M	Christie Mid Back Armchair; M-Spec	940	780	690	700	470	550	510	22
TSCH23M	Christie High Back Armchair; M-Spec	1110	780	690	700	470	550	510	21
TSCH24M	Christie Mid Back 2 Seater Sofa; M-Spec	940	1190	690	700	470	980	510	26.5
TSCH25M	Christie Tub Chair; M-Spec	820	760	670	720	490	550	560	19.5

# Zenda



Its clean lines, supportive proportions, and versatile configuration options make it ideal for a wide range of challenging environments.



**LSZE21M Zenda**  
Mid Back Armchair



**LSZE22M Zenda**  
High Back Armchair  
shown with quilted back option



**LSZE23M Zenda**  
High Back Armchair  
with Wings  
shown with quilted back option



**LSZE24M Zenda**  
Mid Back 2 Seater Sofa  
shown with quilted back option



**LSZE25M Zenda**  
High Back 2 Seater Sofa  
shown with quilted back option



**LSZE26M Zenda**  
High Back 2 Seater Sofa  
with Wings  
shown with quilted back & button option

Zenda redefines challenging environment seating with a sophisticated interpretation of the traditional wing back chair.



### Standard Features

- Profiled back with excellent lumbar support
- Distinctive styling
- M-Spec framework with boarded seat & underside
- Zip fixed back cushion
- Removable seat cushion
- Solid oak legs
- Security fixings throughout

### Optional Features

- Quilted back detail
- Customise from a wide range of fabrics to enhance any space (see pages 32-33)
- Additional weighting options (see page 28)
- Wood finish options available (see page 31)

Code	Product	H	W	D	AH	SH	SW	SD	WT
LSZE21M	Zenda Mid Back Armchair; Removable Seat, M-Spec	990	725	860	600	480	540	570	36
LSZE22M	Zenda High Back Armchair; Removable Seat, M-Spec	1180	725	950	600	480	540	570	40
LSZE23M	Zenda Wingback Armchair; Removable Seat, M-Spec	1180	725	950	600	480	540	570	42
LSZE24M	Zenda Mid Back 2 Seater Sofa; Removable Seat, M-Spec	990	1280	860	600	480	1100	570	52
LSZE25M	Zenda High Back 2 Seater Sofa; Removable Seat, M-Spec	1180	1280	950	600	480	1100	570	59
LSZE26M	Zenda Wingback 2 Seater Sofa; Removable Seat, M-Spec	1180	1280	950	600	480	1100	570	61

# Galloway & Pimlico



**Galloway and Pimlico combine supportive comfort with contemporary elegance, creating welcoming seating suited to lounges, waiting areas and breakout spaces**

Designed with a supportive curved back and well-positioned arms, the collection promotes improved posture, seating comfort and easier mobility while helping create calmer, more inviting environments.



**Standard Features**

- Containment wings on Galloway Curve and Pimlico models
- Matching footstool available (**SSGA05**)
- Flowing design with rounded corners
- M-Spec framework with boarded seat & underside
- Removable or fixed seat or complete upholstery on Galloway models only
- Security fixings throughout

**Optional Features**

- Fluting option on back
- Plus+ one piece cover, fully sealed to prevent concealment and aid cleaning\*
- Customise from a wide range of fabrics to enhance any space (see pages 32-33)
- Reflexion® pressure relief seat
- Additional weighting options available (see page 28)
- Wood glide stain options with Medicote™ anti-bacterial lacquer (see page 31)

\*only available on selected fabrics & vinyl's with strengthened seams



**LSPI02M Pimlico**  
High Back Armchair with Wings & Removable Seat



**SSGA04M Galloway Curve**  
High Back Armchair with Wings



**SSGA03M Galloway**  
High Back Armchair

**LSPI01M Pimlico**  
High Back Armchair with Wings & Fixed Seat



**SSGA01M Galloway**  
Mid Back Armchair



**SSGA02M Galloway**  
Mid Back 2 Seater Sofa



**SSGA05M Galloway**  
Footstool

Available as an armchair or 2 seater sofa. Customise from a wide range of fabrics and finishes to enhance any space.



Code	Product	H	W	D	AH	SH	SW	SD	WT
SSGA01M	Galloway Mid Back Armchair; Removable Seat; M-Spec	910	790	870	630	470	500	540	22.5
SSGA02M	Galloway Mid Back 2 Seater Sofa; Removable Seat; M-Spec	910	1290	870	630	470	990	540	35
SSGA03M	Galloway High Back Armchair; Removable Seat; M-Spec	1035	790	870	630	470	500	540	24.5
SSGA04M	Galloway High Curve Back Armchair; Removable Seat; M-Spec	1035	790	870	630	470	500	540	34.5
SSGA05M	Galloway Footstool	300	440	300	N/A	300	440	300	2.5
LSPI01M	Pimlico Wingback Armchair; Fixed Seat; M-Spec	1070	850	870	630	470	500	540	25
LSPI02M	Pimlico Wingback Armchair; Removable Seat; M-Spec	1070	850	870	630	470	500	540	25

# Vista



Vista combines contemporary styling with supportive comfort through its elegant frame and waterfall seat, enhanced with robust specification options for challenging environments.



### Standard Features

- Distinctive lounge chair
- Show wood frame
- M-Spec framework with boarded seat & underside
- Fixed waterfall seat
- Security fixings throughout

### Optional Features

- Quilted seat & back
- Customise from a wide range of fabrics to enhance any space (see pages 32-33)
- Wood finish options available (see page 31)



**LSVI01M Vista**  
Mid Back Armchair,  
Open Arms



**LSVI02M Vista**  
Mid Back Armchair,  
Upholstered Arms



**LSVI03M Vista**  
Mid Back Armchair,  
Upholstered Arms  
with Handgrips

\*Models above shown with quilted seat & back option

Code	Product	H	W	D	AH	SH	SW	SD	WT
LSVI01M	Vista Mid Back Armchair; Open Arms; Fixed Seat; M-Spec	915	620	770	650	490	550	530	24
LSVI02M	Vista Mid Back Armchair; Upholstered Arms; Fixed Seat; M-Spec	915	620	770	650	490	550	530	29.5
LSVI03M	Vista Mid Back Armchair; Upholstered Arms with Handgrips; Fixed Seat; M-Spec	915	620	770	650	490	550	530	29.5

# Valentino



Compact and stylish, Valentino is at home in any location; easy to move around it offers a flexible seating option and brings a touch of glamour to any room.



### Standard Features

- M-Spec framework with boarded seat & underside
- Comfortable fixed waterfall seat
- Elegant integrated tapered leg
- Security fixings throughout

### Optional Features

- Customise from a wide range of fabrics to enhance any space (see pages 32-33)
- Wood finish options available (see page 31)



**TSVA01M Valentino**  
Tub Chair



**TSVA02M Valentino**  
2 Seater Sofa



Code	Product	H	W	D	AH	SH	SW	SD	WT
TSVA01M	Valentino Tub Chair; Fixed Seat; M-Spec	830	620	600	670	470	450	420	15
TSVA02M	Valentino 2 Seater Sofa; Fixed Seat; M-Spec	830	1100	600	670	470	960	420	20.5

Contemporary, robust and versatile tub chair ranges with extreme construction, additional weighting options, and softer residential styling for use in bedroom, lounge and reception areas.



# Tub+ Multi-use Chairs



**Multiple finish options available**  
see pages 30-33 for further information

# Tub Chairs



Our modern tub chair collection combines robust security-focused structure with improved comfort, softer aesthetics and flexible specification options to support calmer, more safer spaces.



**TSME01X Meridian**  
Tub Chair



**TSME02X Meridian**  
2 Seater Sofa



**Standard Features:**

- See page 110 for full Meridian specification
- See page 118 for full Suki specification
- See page 38 for full Roku® specification
- See page 143 for full Valentino specification
- See page 136 for full Christie specification
- See page 132 for full Fawley specification



**TSSU01 Suki**  
Tub Chair



**TSSU03 Suki**  
2 Seater Sofa



**TSRK23 Roku®**  
Upholstered Tub Chair



**TSVA01M Valentino**  
Tub Chair



**TSVA02M Valentino**  
2 Seater Sofa



**TSCH25M Christie**  
Tub Chair



**TSFA01M Fawley**  
Tub Chair



**TSFA02M Fawley**  
2 Seater Sofa



**Versatile sensory furniture designed to support calmer spaces and de-escalation through soft shapes, adaptable layouts and gentle sensory stimulation.**



# Sensory, De-escalation + Seclusion



**Multiple finish options available**  
see pages 30-33 for further information

# Flex Shapes

Lightweight, versatile and safe; our popular Flex foam range has a wide range of soft, organic shapes and tapered edge designs, all made from soft block foam and easily arranged to suit any area.



**FSFX01 Flex**  
Foam Cube  
**FSFP01 Flex Plus**  
Heavyweight Foam



**FSFX02 Flex**  
Foam Cylinder  
**FSFP01 Flex Plus**  
Heavyweight Foam



**FSFX17 Flex**  
600rd Cylinder with Scallop  
**FSFX17 Flex Plus**  
Heavyweight Foam



**FSFX03 Flex**  
Small Hexagon  
**FSFP03 Flex Plus**  
Heavyweight Foam



**FSFX04 Flex**  
Wide Hexagon  
**FSFP04 Flex Plus**  
Heavyweight Foam



**FSFX05 Flex**  
Large Hexagon  
**FSFP05 Flex Plus**  
Heavyweight Foam



**FSFX15 Flex**  
Beanbag



**FSFX16 Flex**  
Beanbag with Backrest



### Standard Features (Flex)

- Soft block foam construction
- Fire retardant CMHR foam
- Modular design allows multiple configurations
- Easily arranged to suit any area

### Standard Features (Flex Plus)

- Heavy weighted foam
- Fire retardant CMHR foam
- Modular design allows multiple configurations
- Easily arranged to suit any area

### Optional Features

- Zipped or fully sewn (no zip) options on FSFP01- FSFP05
- Fully sewn (no zip) only on FSFP15 & FSFP16



Code	Product	H	W	D	AH	SH	SW	SD	WT
FSFX01	Flex Large Cube; 600x600	450	600	600	-	450	600	600	16.5
FSFX02	Flex Large Cylinder; 600rd	450	600	600	-	450	600	600	13.5
FSFX03	Flex Hexagon	450	625	555	-	450	625	555	12
FSFX04	Flex Wide Hexagon	450	865	555	-	450	865	555	15
FSFX05	Flex Large Hexagon	450	1260	555	-	450	1260	555	30.5
FSFX15	Flex Beanbag	1160	690	800	-	510	510	540	40
FSFX16	Flex Beanbag with Backrest	630	800	800	-	-	-	-	6

# Flex Seating



**FSFX06 Flex**  
Unit Chair  
**FSFP06 Flex Plus**  
Heavyweight Foam



**FSFX07 Flex**  
Restraining Unit Chair  
**FSFP07 Flex Plus**  
Heavyweight Foam



**FSFX20 Flex**  
Short Seat  
Restraining Chair  
**FSFP20 Flex Plus**  
Heavyweight Foam



**FSFX08 Flex**  
De-escalation Sofa;  
Unit Chair, Restraining Chair,  
Unit Chair  
**FSFP08 Flex Plus**  
Heavyweight Foam



**FSFX21 Flex**  
De-escalation Sofa  
Unit Chair, Short Restraining Chair,  
Unit Chair  
**FSFP21 Flex Plus**  
Heavyweight Foam



**FSFX10 Flex**  
Rocking Lounger  
**FSFP10 Flex Plus**  
Heavyweight Foam

Soft forms, modular flexibility and safe block foam construction combine to create adaptable seating solutions for de-escalation, sensory and wider healthcare environments.



**Standard Features (Flex)**

- Soft block foam construction
- Fire retardant CMHR foam
- Modular design allows multiple configurations
- Easily arranged to suit any area

**Standard Features (Flex Plus)**

- Heavy weighted foam
- Fire retardant CMHR foam
- Modular design allows multiple configurations
- Easily arranged to suit any area

**Optional Features**

- Zipped or fully sewn (no zip) options on FSFP01- FSFP05
- Fully sewn (no zip) only on FSFP15 & FSFP16

Code	Product	H	W	D	AH	SH	SW	SD	WT
FSFX06	Flex Unit Chair	835	550	810	-	480	550	480	10.5
FSFX07	Flex Restraining Unit Chair	835	550	975	-	480	550	645	12
FSFX08	Flex De-escalation Sofa; Restraining chair	835	1650	975	-	480	1650	645	33
FSFX20	Flex Short Seat Restraining Chair	835	550	975	-	435	550	645	27.5
FSFX21	Flex De-escalation Sofa; Short Restraining Chair	835	1650	975	-	480	1650	480	76.5

## De-escalation

The angled lower section creates a supportive footwell with additional space for staff positioning during de-escalation situations.

The lower seating position and sloped footrest design help support stability, comfort and safer intervention.

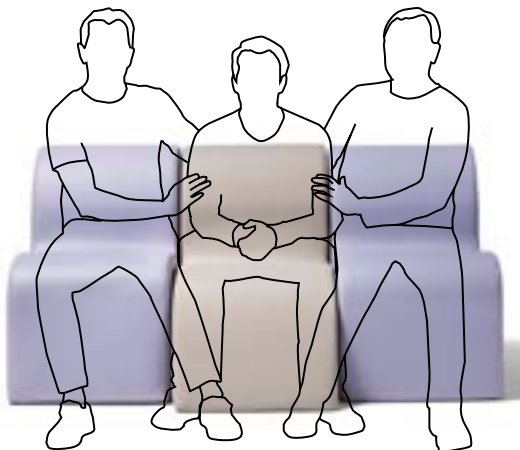

Soothing rocking motion



# Flex Seating



**FSFX12 Flex**  
2 Seater Bench Seat  
**FSFP12 Flex Plus**  
Heavyweight Foam



**FSFX14 Flex**  
3 Seater Bench Seat  
**FSFP14 Flex Plus**  
Heavyweight Foam

**FSFP13 Flex**  
2 Seater Bench Seat with Scallop (shown opposite)  
**FSFP13 Flex Plus**  
Heavyweight Foam



**SSEL01 Elle**  
Extra Large Scatter Cushion



**SSEL02 Elle**  
Extra Large Folding Scatter Cushion



Versatile Flex foam seating is designed to appeal to CAMHS, young people, autism, learning disabilities, seclusion zones and wider healthcare settings such as hospital waiting areas, corridors and paediatrics.

**Standard Features (Flex)**

- Soft block foam construction
- Fire retardant CMHR foam
- Modular design allows multiple configurations
- Easily arranged to suit any area

**Standard Features (Flex Plus)**

- Heavy weighted foam
- Fire retardant CMHR foam
- Modular design allows multiple configurations
- Easily arranged to suit any area

**Optional Features**

- Zipped or fully sewn (no zip) options on FSFP01- FSFP05
- Fully sewn (no zip) only on FSFP15 & FSFP16



**FSFX09 Flex**  
Lounger (non rocking)  
**FSFP09 Flex Plus**  
Heavyweight Foam



**FSFX10 Flex**  
Rocking Lounger  
**FSFP10 Flex Plus**  
Heavyweight Foam



**FSFX11 Flex**  
Lounger Footstool  
**FSFP11 Flex Plus**  
Heavyweight Foam

**Flex Lounger & Rocking Lounger**

- Ideal for lounging, gaming, relaxation and de-escalation
- Rounded bottom on FSFP10 allows gentle, calming rocking motion
- Matching footstool for comfort and to stop rocking motion

Code	Product	H	W	D	AH	SH	SW	SD	WT
FSFX09	Flex Lounger	925	600	920	-	475	600	480	10
FSFX10	Flex Rocking Lounger	925	600	920	-	475	600	480	20
FSFX11	Flex Lounger Footstool	475	600	790	-	-	-	-	7.5
FSFX12	Flex 2 Seater Bench Seat	470	1375	620	-	470	1375	620	12.5
FSFX13	Flex 2 Seater Bench Seat with Scallop	470	1310	620	-	470	1310	470	12
FSFX14	Flex 3 Seater Bench Seat	470	2130	620	-	470	2130	620	19
FSFX17	Flex Cylinder; 600rd with Scallop	450	600	530	-	450	600	530	5.5
SSEL01	Extra Large Scatter Cushion	330	1000	1000	-	330	1000	1000	5.3
SSEL02	Extra Large Folding Scatter Cushion	330	2000	1000	-	330	2000	1000	10.6

# Jetson



Designed to support movement, self-regulation and comfort. It's gentle rocking motion provides calming sensory feedback, while it's soft upholstery and contemporary residential aesthetic allow Jetson to feel welcoming and non-clinical, while remaining practical for challenging environments.



## Standard Features

- Gentle, calming rocking action for relieving tension
- Contemporary styling for the modern care facility
- Stops quickly on its own - 'comes to rest'
- Sturdy construction
- Difficult to pick up

## Optional Features

- Wood finish options available (see page 31)

Code	Product	H	W	D	AH	SH	SW	SD	WT
RCJE21	Jetson Sensory Motion Armchair; Fixed Seat	1045	870	910	590	410	530	570	45

Jetson is a generously proportioned, comfortable, contemporary rocking chair suitable for use in low to medium risk areas.



REJE21 Jetson  
Sensory Motion Chair



**"I work with many individuals who seek movement and this helps them in a variety of ways; to be more alert, to cope with feeling over alert, or to generally self soothe.**

Jetson is a sturdy modern chair that has a linear motion and is solid enough to support adults with behaviour that can challenge or some gross motor difficulties such as heavy sitting. The linear movement can be calming for individuals and often they like to self-manage the rate and

speed of motion. Jetson is ideal, as it is comfortable, supports transfers for those mobile enough to access it, yet is sturdy.

It does not look clinical, so would suit a multitude of environments. It is both a comfortable chair and a therapeutic tool within the environment".

- Lead Occupational Therapist working in Adult Learning Disabilities



Creating Bedroom environments focused on nurturing, comfort and wellbeing through practical storage, robust construction, flexible configurations and safety focused design to create a homelike space in challenging environments.



# Bedroom Furniture



Multiple finish options available  
see pages 30-33 for further information

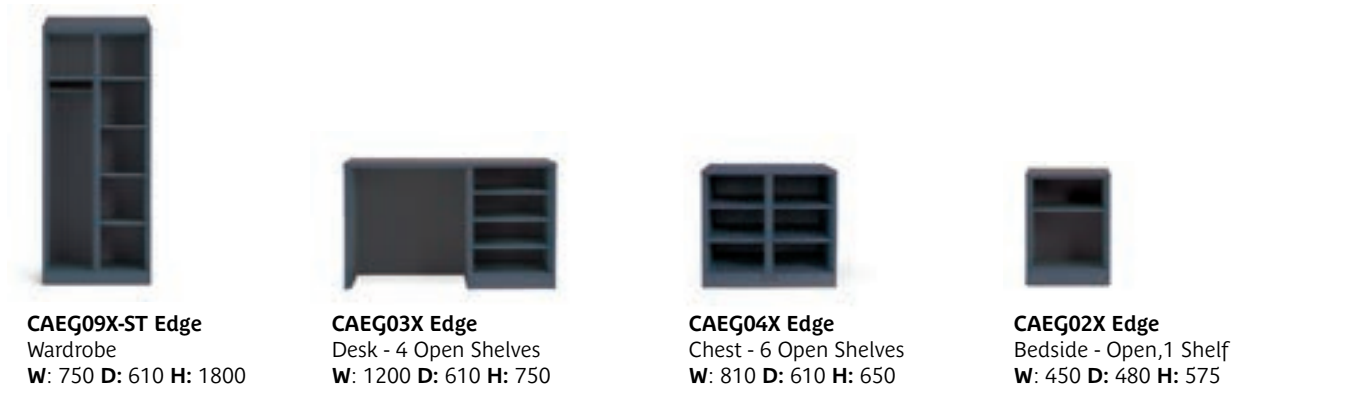

**Standard Features**

- X-Spec framework fully boarded for enhanced security
- Security fixings used throughout
- 18mm MFC carcass and top with colour matched 2mm edging
- No doors for full visibility
- Double skinned internal vertical panels for enhanced strength & support
- Half depth ligature reducing clothes hanging shelf in wardrobe models
- Sloping top available on all wardrobe models

**Optional Features**

- Range of wardrobe options; fully shelved, full hanging, half and half
- Wood finish options available (see page 31)
- Available in all standard MFC finishes (see page 31)

# Edge

Crafted with a tough MFC carcass and double skinned vertical panels for extreme strength, Edge features an integrated ligature reducing sloping top and no doors for full visibility.



OH: 575  
OW: 460  
OD: 480

**CAEQ01X**  
Bedside Unit  
3 Shelves



OH: 575  
OW: 460  
OD: 480

**CAEQ02X**  
Bedside Unit  
Upper Shelf  
Lower Shelf



OH: 750  
OW: 1200  
OD: 630

**CAEQ03X**  
Dressing Table  
4 Shelves Pedestal  
with Magazine Shelf

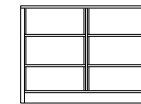

OH: 650  
OW: 810  
OD: 480

**CAEQ04X**  
Storage unit  
6 Shelves

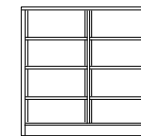

OH: 835  
OW: 810  
OD: 480

**CAEQ05X**  
Storage unit  
8 Shelves

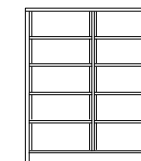

OH: 835  
OW: 810  
OD: 480

**CAEQ06X**  
Storage unit  
10 Shelves

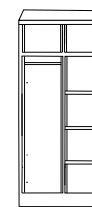

OH: 1810  
OW: 900  
OD: 610

**CAEQ09X-ST**  
Double Wardrobe  
Half Shelved  
Half Hanging Interior  
Sloping Top

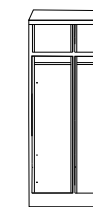

OH: 1800  
OW: 900  
OD: 610

**CAEQ15X-ST**  
Double Wardrobe  
Full Width  
Hanging Interior  
Sloping Top

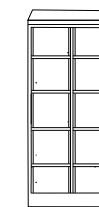

OH: 1800  
OW: 900  
OD: 610

**CAEQ20X-ST**  
Double Wardrobe  
Full Width  
Full Shelved  
Sloping Top



**Additional wardrobe sizes available**



# Insight

Insight is an open-fronted bedroom furniture range developed with robust X-Spec construction and secure detailing to support enhanced visibility, safety and everyday use.



**CAIN08X Insight**  
Wardrobe  
W: 750 D: 610 H: 1800



**CAIN03X Insight**  
Dressing Table  
W: 1200 D: 610 H: 750



**CAIN04X Insight**  
Desk - 6 Open Shelves  
W: 810 D: 480 H: 650



**CAIN02X Insight**  
Bedside - Open, 1 Shelf  
W: 460 D: 480 H: 575







Low to High Risk

### Standard Features

- X-Spec framework fully boarded for enhanced security
- 18mm MFC carcass and top with colour matched 2mm edging
- No doors for full visibility
- Security fixings used throughout
- Half depth ligature reducing clothes hanging shelf in wardrobe models
- Sloping top available on all wardrobe models

### Optional Features

- Range of wardrobe options; fully shelved, full hanging, half and half
- Wood finish options available (see page 31)
- Available in all standard MFC finishes (see page 31)



OH: 575  
OW: 460  
OD: 480

**CAIN01X**  
Bedside Unit  
3 Shelves



OH: 575  
OW: 460  
OD: 480

**CAIN02X**  
Bedside Unit  
2 Shelves



OH: 750  
OW: 1200  
OD: 630

**CAIN03X**  
Dressing Table  
3 Shelf Pedestal  
with Magazine Shelf

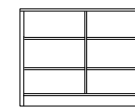

OH: 650  
OW: 810  
OD: 480

**CAIN04X**  
Chest of Drawers  
6 Shelves

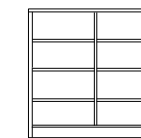

OH: 835  
OW: 810  
OD: 480

**CAIN05X**  
Chest of Drawers  
8 Shelves

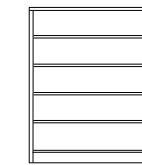

OH: 835  
OW: 810  
OD: 480

**CAIN06X**  
Chest of Drawers  
10 Shelves



OH: 1810  
OW: 600  
OD: 610

**CAIN07X**  
Single Wardrobe  
Open Fronted  
Fully Shelved Interior

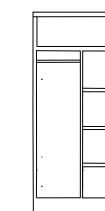

OH: 1800  
OW: 750  
OD: 610

**CAIN08X**  
Double Wardrobe  
Half Shelved  
Half Hanging Interior

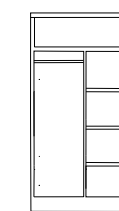

OH: 1800  
OW: 900  
OD: 610

**CAIN09X**  
Double Wardrobe  
Half Shelved  
Half Hanging Interior

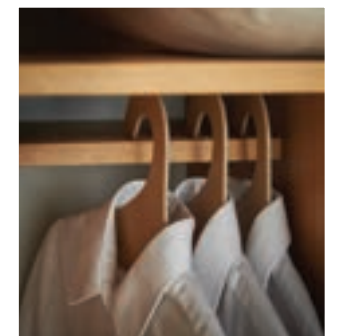

**Additional wardrobe sizes available**



# Solstis

Solstis combines subtle contemporary styling with practical safety-focused detailing to create bedroom furniture that feels softer, calmer and less institutional.

Featuring sleek wrap-around drawer fronts, soft edge tops and reduced ligature scoop handles, the collection has been designed to support more welcoming environments without any compromise on safety or strength.



**CASO11X Solstis**  
Double Wardrobe  
W:760 D: 610 H: 1800

**CASO06X Accent**  
Desk - 3 Drawers  
W: 1210 D: 580 H: 750

**CASO07X Accent**  
3 Drawer Chest  
W: 810 D: 480 H: 650

**CASO02X Accent**  
Bedside Cabinet  
W: 460 D: 480 H: 575

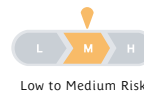

### Standard Features

- X-Spec framework fully boarded for enhanced security
- 18mm MFC carcass and top with colour matched 2mm edging
- 25mm MDF vinyl wrap soft edge tops
- 18mm MDF vinyl wrap soft edge drawer and door fascia panel
- Integrated ligature reducing scoop handles
- Piano hinges to all doors
- All drawers are non-removable
- Security fixings used throughout
- Half depth ligature reducing clothes hanging shelf in wardrobe models

### Optional Features

- Sloping top available on all wardrobe models
- Wood finish options available (see page 31)
- Available in all standard MFC finishes (see page 31)



OH: 575  
OW: 460  
OD: 480

**CASO01X**  
Bedside Unit  
3 Drawers



OH: 575  
OW: 460  
OD: 480

**CASO02X**  
Bedside Unit  
Upper Drawer  
Lower Door



OH: 575  
OW: 460  
OD: 480

**CASO04X**  
Bedside Unit  
Open Upper  
Open Lower



OH: 750  
OW: 1210  
OD: 580

**CASO06X**  
Dressing Table  
3 Drawer Pedestal  
with Magazine Shelf

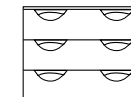

OH: 650  
OW: 810  
OD: 480

**CASO07X**  
Chest of Drawers  
3 Drawers

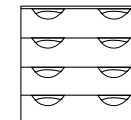

OH: 830  
OW: 810  
OD: 480

**CASO08X**  
Chest of Drawers  
4 Drawers

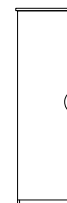

OH: 1800  
OW: 610  
OD: 610

**CASO10X**  
Single Wardrobe  
Single Door

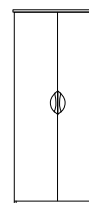

OH: 1800  
OW: 760  
OD: 610

**CASO11X**  
Double Wardrobe  
Double Door

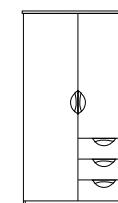

OH: 1800  
OW: 1000  
OD: 610

**CASO13X**  
Double Wardrobe  
Double Door  
3 Lower Drawers

**Additional wardrobe sizes available**



**CAAC11X Accent**  
Double Wardrobe  
W:750 D: 610 H: 1800



**CAAC06X Accent**  
Desk - 3 Drawers  
W: 1200 D: 630 H: 750



**CAAC07X Accent**  
3 Drawer Chest  
W: 810 D: 480 H: 650



**CAAC02X Accent**  
Bedside Cabinet  
W: 460 D: 480 H: 575



**Standard Features**

- X-Spec framework fully boarded for enhanced security
- 18mm MFC carcass and top with colour matched 2mm edging
- 25mm MDF vinyl wrap soft edge tops
- 18mm MDF vinyl wrap soft edge drawer and door fascia panel
- Integrated cutout handles for internal viability
- Piano hinges to all doors
- Angled top to wardrobe doors
- All drawers are non-removable
- Security fixings used throughout
- Half depth ligature reducing clothes hanging shelf in wardrobe models

**Optional Features**

- Sloping top available on all wardrobe models
- Wood finish options available (see page 31)
- Available in all standard MFC finishes (see page 31)

# Accent

Designed for low to medium risk environments, Accent combines integrated cut-out handles, angled wardrobe tops and robust X-Spec construction with clean contemporary styling to support safer, less institutional bedroom spaces.



OH: 575  
OW: 460  
OD: 480

**CAAC01X**  
Bedside Unit  
3 Drawers

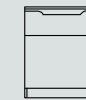

OH: 575  
OW: 460  
OD: 480

**CAAC02X**  
Bedside Unit  
Upper Drawer  
Lower Door



OH: 575  
OW: 460  
OD: 480

**CAAC04X**  
Bedside Unit  
Open Upper  
Open Lower

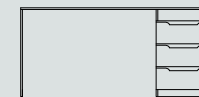

OH: 750  
OW: 1200  
OD: 630

**CAAC06X**  
Dressing Table  
3 Drawer Pedestal  
with Magazine Shelf



OH: 650  
OW: 810  
OD: 480

**CAAC07X**  
Chest of Drawers  
3 Drawers



OH: 835  
OW: 810  
OD: 480

**CAAC08X**  
Chest of Drawers  
4 Drawers



OH: 1810  
OW: 600  
OD: 610

**CAAC10X**  
Single Wardrobe  
Single Door

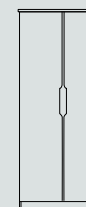

OH: 1800  
OW: 750  
OD: 610

**CAAC11X**  
Double Wardrobe  
Double Door

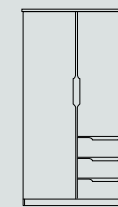

OH: 1800  
OW: 1000  
OD: 610

**CAAC13X**  
Double Wardrobe  
Double Door  
3 Lower Drawers

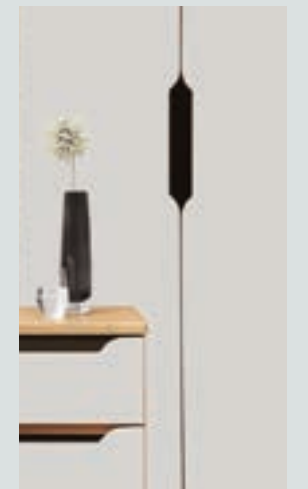
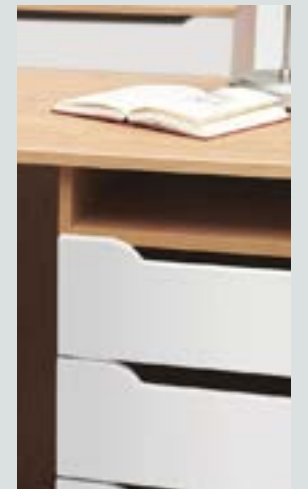

**Additional wardrobe sizes available**

# Myla



Myla Bed is a secure, extremely durable solution designed to support safer interaction within challenging environments, with flexible fixing and sizing options to suit a wide range of room layouts.



## Standard Features

- Durable MDF vinyl wrapped construction
- 22mm soft edge top
- Channelled platform allows easy cleaning and air to circulate under the mattress
- Sloping sides; enables easy staff access for cleaning or assisting a service user. Aids sit-to stand movement.
- Waterfall edging around platform/base prevents fluid ingress and improves cleaning
- Internal support sections provide enhanced strength
- Mattress retainers

## Optional Features

- Laminate & Vinyl finish options available (See page 31)

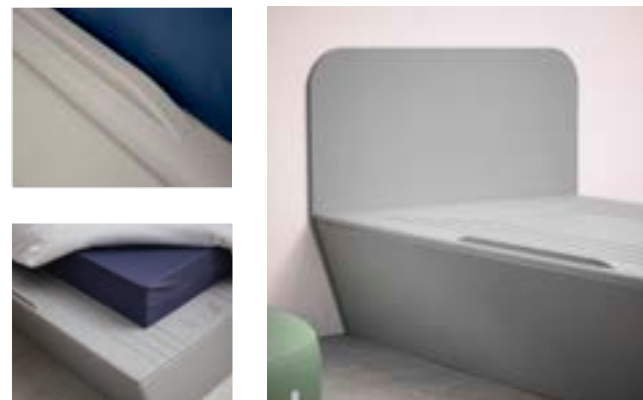

## Sloping Sides

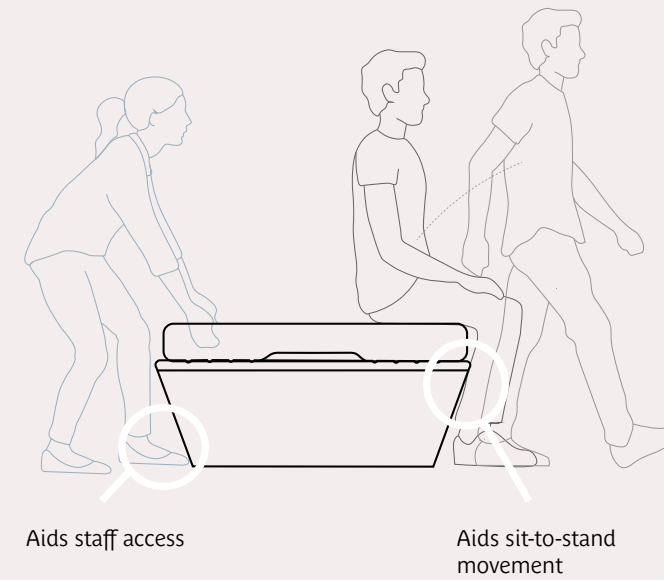

- Unique design aids infection control, while also reducing manual handling issues
- Sloping sides enable staff to work closer to the bed and service users to get out of bed much more easily

**X-Specification  
with rounded  
corners and no gaps  
or sharp edges**

## Size options:



Single Myla



Small Double Myla



Double Myla

## Fixing options:

*Myla can be wall fixed (handed left, right or central) dependent on room layout and access.*

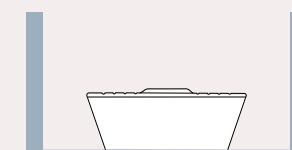

**BDMY21 Myla**  
Central Freestanding

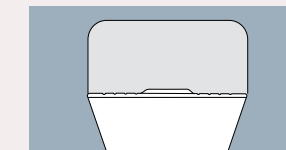

**BDMY22 Myla**  
Central Wall Fixed

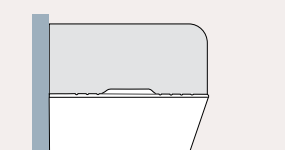

**BDMY23 Myla**  
Left Hand Wall Fixed

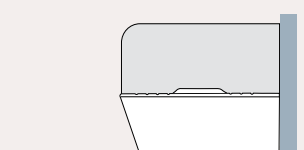

**BDMY24 Myla**  
Right Hand Wall Fixed

*Each Myla bed has its Headboard counterpart*

**HBMY22 Myla**  
Central Wall Fixed Headboard

**HBMY23 Myla**  
Left Hand Wall Fixed Headboard

**HBMY24 Myla**  
Right Hand Wall Fixed Headboard

# Ottoman



Security fixings and an integrated rebated mattress platform support safer everyday use.



Ottoman can be wall fixed (handed left, right or central) dependent on room layout and access.

## Headboard fixing options:

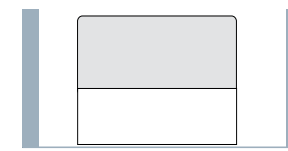

**Ottoman Bed**  
Central Freestanding

**HBOT21** - Single  
**HBOT31** - Small Double  
**HBOT41** - Double



**Ottoman Headboard**  
Central wall fixed

**HBOT22** - Single  
**HBOT32** - Small Double  
**HBOT42** - Double

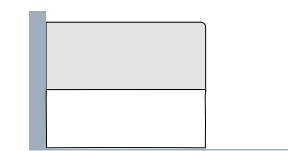

**Ottoman Headboard**  
Left Hand Wall Fixed

**HBOT23** - Single  
**HBOT33** - Small Double  
**HBOT43** - Double

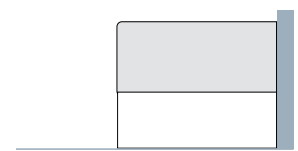

**Ottoman Headboard**  
Right Hand Wall Fixed

**HBOT23** - Single  
**HBOT33** - Small Double  
**HBOT43** - Double

Balancing robust construction with clean, minimal styling, the Ottoman Bed has been designed to create calmer bedroom spaces while supporting long-term performance within challenging environments.



**BDOT21X Ottoman**  
Single Bed  
Freestanding



**BDOT31X Ottoman**  
Small Double Bed  
Freestanding



**BDOT41X Ottoman**  
Double Bed  
Freestanding

### Standard Features

- X-Spec framework fully boarded for enhanced security
- 18mm MFC construction with colour matched 2mm edging internal support sections providing enhanced strength
- Recessed mattress tray to prevent mattress movement
- Secure non-removable fixings

### Optional Features

- Wall fixing options; centrally wall fixed, left or right wall handed to suit rooms layouts
- Matching headboards available
- Wood finish options available (see page 31)

# Mattresses

PU fully welded and anti-vandal PVC bed base and mattress options. Available with integrated pillow option.

All Mattresses come in standard, small double & double sizes, Crib 5. Crib 7 option available.



**BDRE21 Revival Plus**  
PU Welded Mattress  
W: 915 D: 1900 H: 200



**BDHO21 Horizon Plus**  
Anti-vandal PVC Mattress  
W: 915 D: 1900 H: 200



**BDHO27 Horizon Plus**  
Anti-vandal PVC Bed Base  
W: 915 D: 1900 H: 300



**BDRE24 Revival Plus**  
PU Welded Mattress with  
Integrated Pillow  
W: 915 D: 1900 H: 200



**BDHO31 Horizon Plus**  
Anti-vandal PVC Mattress with  
Integrated Pillow  
W: 915 D: 1900 H: 200



**BDHO31 Horizon Plus**  
Anti-vandal PVC One Piece Mattress  
and Bed Base  
W: 915 D: 1900 H: 500

From secure media units and modular layouts to robust cabinetry and reduced ligature detailing, each solution has been developed to support challenging environments with a more residential and calmer feel.



# Lounge Cabinets



**Multiple finish options available**  
see pages 30-33 for further information

# Visio Media

Combination unit with stylish TV housing and co-ordinating lower media cabinet, featuring reduced ligature profile and lockable polycarbonate screen.



Reduced ligature detailing, concealed fixings and robust construction support safer, more considered lounge spaces while maintaining a calmer, more domestic feel.



**LCVM01** (to fit 43" TV)  
Visio Media TV Housing Cabinet  
W: 1330 D: 225 H: 865



**LCVM02** (to fit 55" TV)  
Visio Media TV Housing Cabinet  
W: 1395 D: 225 H: 1015



**LCVM03 Visio Media**  
2 Door Media Cabinet  
W: 1350 D: 500 H: 600



**LCVM04 Visio Media**  
2 Door Media Cabinet  
W: 1350 D: 500 H: 900



**LCVM05 Visio Media**  
3 door Media cabinet  
W: 1615 D: 500 H: 600



**LCVM06 Visio Media**  
3 door Media cabinet  
W: 1615 D: 500 H: 900



### Standard Features

- Reduced ligature profile with sloping top
- 18mm MFC vinyl wrapped soft edge top
- 8mm Polycarbonate screen with lockable access panel
- Reduced ligature ventilation grilles
- To reduce ligature risk lower cabinet features piano hinges, fixed shelves and integrated scoop handles
- Lockable middle door as standard

### Optional Features

- 600 or 900mm height Media unit
- Wall fixing option
- Available in all standard MFC finishes (see page 31)

# Leto

Designed to bring a softer, more domestic aesthetic, the modular Leto range combines full security specification with flexible layout options, practical storage and a wide choice of finishes.

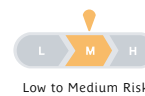

## Standard Features

- X-Spec framework fully boarded for enhanced security
- 18mm MFC carcass and top with colour matched 2mm edging
- 18mm MDF vinyl wrap soft edge drawer and door fascia panel
- Piano hinges to all doors
- Security fixings used throughout

## Optional Features

- Wall fixing option
- Available in all standard MFC finishes (see page 31)

A TV Unit, Cube unit and Bookcase unit are available and can be configured to suit



**LCLE01 Leto**  
Open TV Unit (open)  
W: 1200 D: 380 H: 400

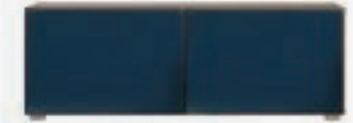

**LCLE11 Leto**  
Open TV Unit (with doors)  
W: 1200 D: 380 H: 400

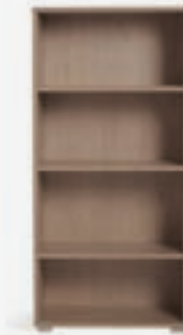

**LCLE02**  
Leto Bookcase unit (open)  
W: 600 D: 380 H: 1225

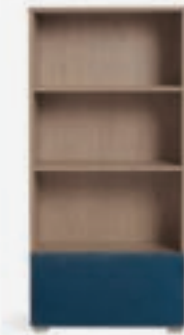

**LCLE12**  
Leto Bookcase unit  
W: 600 D: 380 H: 1225

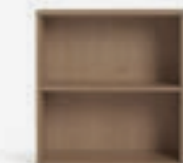

**LCLE03 Leto**  
Open Cube Unit  
W: 600 D: 380 H: 625



**LCLE13**  
Leto Cube unit  
W: 600 D: 380 H: 625

# Visio



Reduced ligature detailing, concealed fixings and robust construction support safer, more considered lounge spaces while maintaining a calmer, more domestic feel.



**LCVI21X Visio 32"**  
W: 925 D: 175 H: 785



**LCVI22X Visio 43"**  
W: 1169 D: 175 H: 920



**LCVI23X Visio 55"**  
W: 1433 D: 175 H: 1070



**LCVI24X Visio 65"**  
W: 1656 D: 175 H: 1195

Visio combines secure TV housing and modular storage within a contemporary X-Spec system designed for secure environments.



### Standard Features

- Reduced ligature sloping top & base
- Vinyl wrapped soft edge framing
- Reduced ligature ventilation grilles
- 8mm polycarbonate screen with lockable removable access panel
- Wall fixed as standard
- Size options to suit TV's up to 32", 43", 55" & 65"

### Options

- Available in all standard MFC finishes (see page 31)



# Lounge Cabinets



Designed to support safer, more organised living spaces through durable construction, secure detailing, practical storage and contemporary styling.



Low to High Risk

## Standard Features

- X-Spec framework fully boarded for enhanced security
- 18mm MFC carcass with colour matched 2mm edging
- 25mm MDF vinyl wrap soft edge top
- 18mm MDF vinyl wrap soft edge drawer and door fascia panel
- Piano hinges to all doors
- All drawers are non-removable

## Handle Features

- Solstis - integrated scoop handles
- Accent - integrated cutout handles for internal visibility

## Options

- Key locks to drawers & doors
- Available in all standard MFC finishes (see page 31)



**LCS003X Solstis**  
TV unit

W: 910 D: 480 H: 525



**LCS004X Solstis**  
TV unit with  
2 doors

W: 910 D: 480 H: 836



**LCS005X Solstis**  
Open TV unit with  
3 shelves & 4 drawers

W: 1400 D: 480 H: 600



**LCS006X Solstis**  
Sideboard with  
2 doors & 2 drawers

W: 910 D: 480 H: 836



**LCS007X Solstis**  
Sideboard with  
1 door & 4 drawers

W: 910 D: 480 H: 836



**LCS008X Solstis**  
Sideboard with  
2 doors & 4 drawers

W:1358 D: 480 H: 836



**LCS012X Solstis**  
Sideboard with  
3 doors

W:1358 D: 480 H: 836



**LCS009X Solstis**  
Bookshelf  
with 4 shelves

W: 910 D: 355 H: 1250



**LCS011X Solstis**  
Display Unit  
with 4 shelves & 1 drawer

W: 910 D: 480 H: 1800

**LCS010X Solstis**  
Bookshelf  
with 5 shelves

W: 910 D: 480 H: 1800

## Ordering:

To order the lounge furniture range required, insert the appropriate product code (shown right).

The Solstis range order codes (**SO**) are shown with the images above.

## Ranges:

**SO** - Solstis

**AC** - Accent

**Additional ranges available.**  
See [www.teal.co.uk](http://www.teal.co.uk) for details.

# Smart safe



SmartSafe is a unique, bespoke safe that can be manufactured to integrate seamlessly into a wide range of environments – either within a wardrobe, bedside locker or other storage space.



## Standard Features

- Integrated plastic hinge made from a folded polypropylene frame for no gaps
- Security screw fixings to form a secure structure
- Retrofit to any existing space
- Keyless locking - client code and management code to reset / override to gain access
- Internal locking mechanism is covered/protected

## Options

- Range of finish options available on request

Ideal for secure storage and can be set to the depth of its location to increase safety and reduce potential damage to the unit.

### Bespoke solution for your storage space.

Send us your dimensions (width + depth)

Let us know if you need it flush fit or inset

Choose from a range of finishes

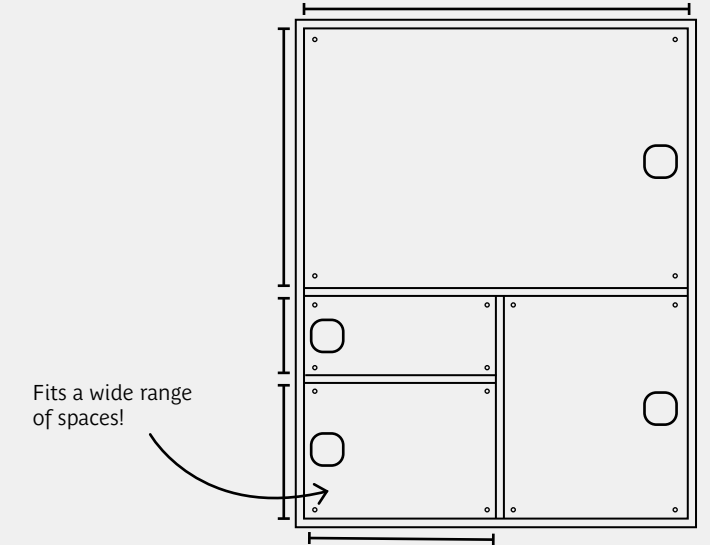

Available in an extensive choice of finishes and configurations, to suit individual project requirements or retrofitted into existing environments.

### Flush installation:



### Inset SmartSafe:

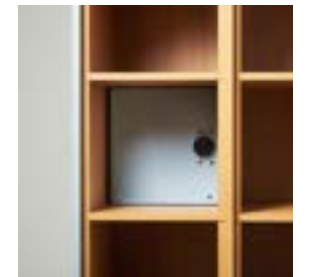

For more information or a bespoke quote contact your local Area Sales Manager or email [sales@teal.co.uk](mailto:sales@teal.co.uk)



**Teal is a British manufacturer specialising in healthcare and challenging environments, with almost 50 years of expertise in designing furniture that combines safety, durability and contemporary design.**

We believe environments have the power to influence how people feel, recover and experience care. That's why every product is intentionally created to support more human-centred spaces.

Our end-to-end manufacturing approach gives us complete control over quality, consistency and lead times delivering lasting value without compromising on performance or patient experience.

**teal**

Branch Road  
Lower Darwen  
Lancashire  
BB3 0PR

Tel: +44 (0) 1254 688210  
Sales Freephone: 0800 980 8998  
Email: [sales@teal.co.uk](mailto:sales@teal.co.uk)  
[www.teal.co.uk](http://www.teal.co.uk)

**The Senator Group**

Issue 1 05/26